

MARINE



CABLE & PIPE TRANSITS

FOR MARINE APPLICATIONS

We Seal Your World™



Safe Blue Seal

There is a simple way of bringing peace and safety to a ship, no matter if it is an advanced navy ship, an offshore supply vessel or the world's biggest luxury cruise liner. Make sure you specify, design for and install Roxtec cable and pipe transits – the blue seals made for the Seven Seas.

Efficient solutions

Roxtec cable and pipe transits ensure operational reliability by providing certified protection against fire, gas, water and dust. The corrosion resistant and area efficient seals help you reduce vibration, noise, and overall weight. They are also available in EMC versions for electrical safety and protection against electromagnetic interference and as ATEX/IECEx certified products for use in explosive atmospheres.

Upgrade – anytime

The Roxtec sealing system is easy to use and quick to install. The sealing modules are adaptable to cables and pipes of different sizes and offer built-in spare capacity for future needs and upgrades. You can open up the transits whenever you want – and just add new cables or pipes.



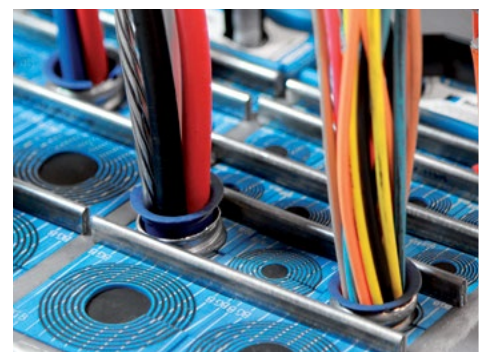
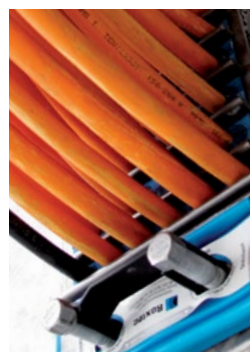
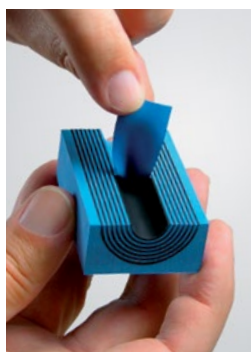
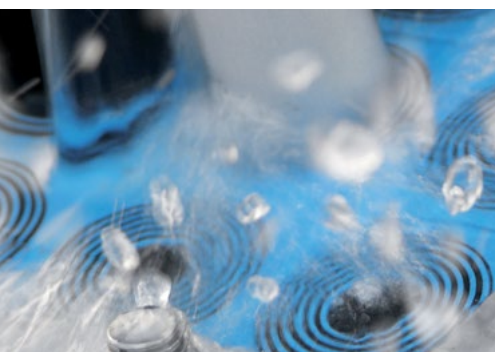

ROXTEC IN ACTION 6

Application areas	8
Sealing solutions for any ship	12
First class performance	18
Focusing on sustainability	20
Roxtec Transit Designer	22

THE ROXTEC SEALING SYSTEM 24

System components	26
Roxtec modules	
RM modules	27
CM modules	29
Wedges	32
Stayplates	35
Lubricant/Assembly gel	37

CABLE ENTRY SOLUTIONS 38

Regular frames and seals	39
S frame	40
SRC frame	47
SK frame	52
SBTB frame	54
SF frame	56
GHM frame	61
R frame	63
Sleeves for R frame	66
RS seal	69
Sleeves for RS seal	73

RS OMD seal	78
RX frame	81
RS X seal	81

Enclosure solutions 85

ComSeal LW	86
ComSeal	88
CF 8/CF 32 frames	91
KFO frame	94
C KFO frame	96
G frame	98

EMC SEALING SYSTEM 102

Electromagnetic compatibility	103
EMC sealing system selection guide	109
EMC modules	
RM BG B, RM BG modules	110
RM ES B, RM ES modules	112
RM PE B, RM PE modules	115
CM BG B modules	118
CM ES modules	119
CM PE modules	120
EMC Wedge	121
EMC frame selection guide	123
Ground lug	123
EMC marking tool	123
Frames/seals for EMC applications	124
R EMC frame	125
RS EMC seals	127

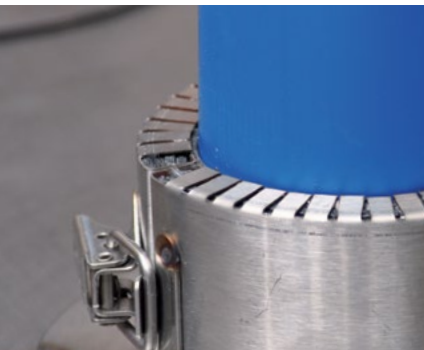

ComSeal EMC	129
CF 8 EMC/CF 32 EMC frames/kits	131
Roxtec EMC installation – basic steps	133

PIPE ENTRY SOLUTIONS 134

Metal pipe solutions	137
RS seal	138
Sleeves for RS frame	142
RS OMD seal	147
R frame	150
Sleeves for R frame	153
SPM seal	156
RX frame	159
RS X seal	159
S frame	163
Plastic pipe solutions	170
RS PPS/S single-side seal	172
Sleeves for RS PPS/S seal	174
RS PPS back-to-back seal	176
Sleeves for RS PPS seal	179
SE PPS extension frame	180
Sleev-it Fire penetration seal	182
Sleev-it Waterproof penetration seal	185
Sleev-it Transition collar	188
Water-tightness after fire solutions	190
RS F+WT	191
RS PPS/S F+WT	192
RS PPS F+WT	194
Roxtec pipe seal selection guide	196

RETROFIT SOLUTIONS 200

CUSTOMIZED SOLUTIONS 206

CABLE AND PIPE MANAGEMENT 210

Cable straps	212
Roxtec installation tools	214

EASY INSTALLATION WITH ROXTEC 220

Installation instructions	221
Training and inspections	253

PRACTICAL USER GUIDELINES 264

Welding	266
Bolting	276
Insulation	283
Templates and holecut patterns	284

ROXTEC IN ACTION







Discover some of the applications in the marine industry where Roxtec cable and pipe transits are used to protect life and sensitive equipment. Approved by all major classification societies, Roxtec transits are recommended both for new build and retrofit projects.

PROPULSION ROOM

Propulsion machinery spaces.

Needs and requirements

- Fire protection
- Gas-tight
- Watertight
- EMI protection
- Capacity to withstand temperature changes
- Vibration damping
- Area efficient multi-cable management

GAS-TIGHT AREA

Gas-tight seals ideal for use in areas where there is a need for maintaining the pressure.

Needs and requirements

- Firestop
- Water barrier
- Gas-tight
- Pressure resistant

EMC APPLICATION AREAS

Sensitive equipment ensuring data, security and functionality onboard.

Needs and requirements

- EMC, electromagnetic compatibility
- Electromagnetic shielding against EMI



Roxtec SRC



Roxtec S



Roxtec SF EMC



SERVICE PIPES

Single or multiple pipes for air compression and cooling; plastic pipes for reduction of overall weight.

Needs and requirements

- Fire protection
- Gas-tight
- Watertight
- Noise reduction
- Vibration damping



Roxtec RS

ROOM PENETRATIONS IN DECKS AND BULKHEADS ABOVE THE WATERLINE

Cable and pipe penetrations in decks and bulkheads between fire zones.

Needs and requirements

- Firestop
- Gas-tight
- Watertight
- Multi-cable management

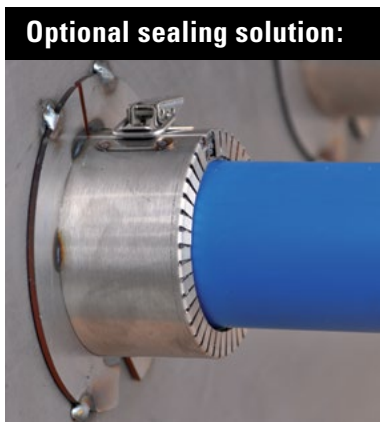

Roxtec Sleeve-it™ Fire penetration seal

CABINS

Light-weight and versatile solutions recommended both for new build and retrofit projects.

Needs and requirements

- Gas-tight
- Watertight
- Easy installation
- Minimal insulation



Roxtec ComSeal™



OUTER LIGHTING

Round seals for single wires through outer bulkheads for external lighting installations.

Needs and requirements

- Area efficient
- Fire protection
- Watertight
- Adaptability to cables of different sizes



Roxtec RS

WATER PIPES

Light-weight seals for steel pipes and plastic pipes as well as fire collars and steel-to-plastic transition collars.

Needs and requirements

- Fire protection
- Gas-tight
- Watertight
- Vibration protection
- Easy installation
- Non-welding solutions



Roxtec RS PPS

CABIN SERVICE LOCKERS

Management and sealing of service pipes and cables connected to the cabin locker area behind the cabin.

Needs and requirements

- Firestop
- Combination of steel and plastic pipes



Roxtec Sleeve-it™ Watertight penetration seal



ROOM PENETRATIONS BELOW THE WATERLINE

Multiple cables penetrating decks and bulkheads.

Needs and requirements

- Fire-proof according to A-0 to A-60 marine fire rating
- Watertight according to class approval programs
- Smoke protection
- Pressure rated
- Vibration damping



Roxtec S

COMMON OPERATION ROOM

Efficient solutions for EMC, electromagnetic compatibility, inside and around the operation room.

Needs and requirements

- Equipment protection
- Data security
- High-precision operation
- Electromagnetic shielding

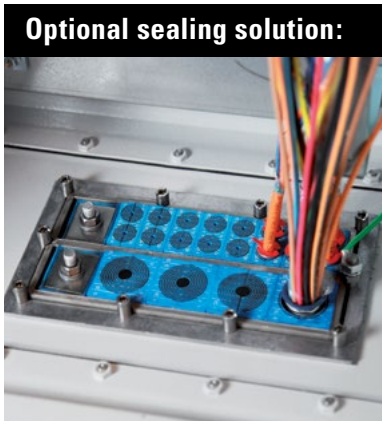

Roxtec CF EMC

BRIDGE OPERATION ROOM

EMC cable and pipe transits developed to guarantee electromagnetic shielding.

Needs and requirements

- Fire-resistant
- Watertight
- Gas-tight
- Electromagnetic shielding
- Protection for sensitive equipment



Roxtec S EMC

Sealing solutions for any ship

Shipbuilders and ship owners standardize with Roxtec transits for cables, metal pipes and plastic pipes. Approved for A class rated sections, the seals handle fire, water, gas pressure, thermal bridges, and material fatigue in any kind of vessel, from work boats to mega yachts.





Cruise liners and ferries

With Roxtec, it is easy to add cables, metal and plastic pipes whenever it is time for new attractions. Upgrades can be performed while cruising – and without risking structure or passenger safety. This barrier against fire and water holds down the total cost of ownership.

Roxtec in the cabin

Roxtec seals are light-weight, versatile and easy to install solutions providing certified fire protection. They prevent fire, gas or water from entering the next compartment. The seals are area efficient and require minimal welding and insulation.



Navy ships

Reliability is key. Besides water-tightness and blast load durability, the Roxtec EMC product line ensures protection against electromagnetic threats and prevents disclosure of electronic signatures. Vibration damping, area efficiency, and plastic pipe solutions contribute to lower overall weight, more space onboard and silent operation. All components have been tested to provide certified protection.

Roxtec in the common operation room

Roxtec has developed efficient solutions for EMC inside and around the operation room. The cable and pipe transits ensure electrical safety. Use Roxtec transits to prevent EMI and secure high-precision operation.



Commercial shipping and supply vessels

Ship owners specify Roxtec to be able to operate their ships and maintain their value for years. Designers and installers all over the world recognize that Roxtec transits make it easy to upgrade and even inspect ships in accordance with new technical and safety demands. For hazardous areas, Roxtec provides ATEX/IECEx certified seals.

Roxtec around the water pipes

Roxtec offers light-weight seals for steel pipes and plastic pipes as well as fire collars and steel-to-plastic transition collars – and all of them are very easy to install. Most Roxtec seals can be installed horizontally or vertically from one side – and there are versions available that do not require any welding.



Special purpose ships

Roxtec standard and customized seals are used for everything from high-precision bow thruster systems to underwater operation equipment and cranes. They protect against fire, gas, water and vibration while keeping the ship prepared for upgrades. This extends the life cycle – without increasing costs.

Gas-tight area

Roxtec solutions do not only act as firestops and water barriers. The seals include features such as gas-tightness, making them ideal for use in areas where there is a need for maintaining the pressure. If, for example, there is a fire nearby and the atmosphere is filled with explosive chemicals and toxic substances, it is crucial to be able to keep dangers out by pressurizing the vessel's interior.



Yachts

Roxtec seals give outstanding possibilities to accommodate new technologies. The ability to handle plastic pipes of different sizes helps reducing overall weight and the risk of corrosion. Add also the excellent sound and vibration damping, which improves the total yachting experience.

Outer lighting

Roxtec round seals for single cables are perfect for use in outer bulkheads when you want to secure external lighting installations, for example on passenger cabin balconies. The solutions are neat and area efficient, and provide superior protection against fire and water.

First class performance

Do you fear a fire onboard? Or water flooding from one compartment to another? We can provide you certified protection – thanks to our thoroughly tested cable and pipe transits.



You can use the Roxtec sealing system to seal all types of penetrating cables, steel pipes and plastic pipes passing through decks and bulkheads, in and between different sections and constructions such as machine rooms, storage rooms, living compartments and the bridge. You can also use it in various types of control cabinets, electrical enclosures and junction boxes.

Certified for peace of mind

Our sealing solutions bring peace of mind to your project, because they have undergone hundreds of registered tests and approvals and received more than 250 certificates showing their excellent performance and resistance to hazards. Roxtec products are fire tested and approved for use in A, B and H class rated sections according to IMO Res. A 754 (18)/IMO FTP 2010 and SOLAS, and tightness tested according to DNV type approval program 8-471.19-1. The Roxtec sealing system is also approved according to different military standards in various countries.

Eliminating risk factors

Roxtec seals ensure protection against fire, water, gas, salt, and dust. They can protect against the risk of explosion, lightning strikes, and noise. They also offer solutions for bonding, grounding, and EMC. The system is well suited for sealing of hydraulic pipes, since the rubber absorbs vibrations. It is a high quality sealing system designed to withstand tough conditions.

- A, H and jet-fire rated
- Gas-tight
- Watertight
- Dust-tight
- Corrosion protection

- Vibration-proof
- Noise reduction
- Blast load protection
- Hazardous locations

- Electromagnetic shielding
- Potential equalization
- Lightning strike protection
- Bonding and grounding

Safety awareness

Our process of developing standard sealing products and creating customized solutions is supported by our procedures for testing. We have a technical center with an advanced test laboratory in combination with a fire laboratory, daily used for R&D, indicative as well as third party witnessed tests. Our type approval certificates, issued by the classification societies, are of course issued on basis of tests conducted at IMO recognized/ accredited test laboratories.

- A and B class fire (standard, fibrous)
- H class fire (hydrocarbon, oil-based)
- Water pressure tests up to 6 bar
- Gas pressure test up to 2.5 bar
- Pull-out tests
- Periodic cycling
- Simulated IP rating tests
- EMC testing
- Vibration testing and analyzing

Verified by inspectors

Roxtec products are certified by all leading classification societies such as Lloyd's Register of Shipping, American Bureau of Shipping, Bureau Veritas, DNV GL and Russian Maritime Register of Shipping.

It is, however, important to remember that the certified protection provided by the Roxtec sealing system depends on correct attachment to the structure by welding or bolting as well as a correct installation procedure. Read more about this on pages 220 and 264 and on www.roxtec.com.





Focusing on sustainability

We do not just believe in safety. We also care about the people, the nature and the oceans of our beautiful blue planet. Therefore, we assure quality and minimize our environmental impact.

Roxtec International is certified in accordance with the quality and environmental standards ISO 9001 and ISO 14001. Among the components we produce, you find steel frames and vulcanized rubber, but you can be sure that no Roxtec labeled products contain any dangerous materials. We follow national and international environmental legal requirements. We respect environmental objectives and ethical issues as well as issues concerning chemicals and law requirements such as RoHS and REACH. We also handle our waste correctly to save our planet.





Design your own transits

The Roxtec Transit Designer™ is a free, web-based engineering tool. It allows auto-planning, drives project efficiency and reduces the risk of mistakes in all project phases.

The Roxtec Transit Designer simplifies product selection as well as the entire process of designing, purchasing and installing cable and pipe transits. Its batch import with auto validation feature helps designers create and update thousands of transits automatically and take full control of their largest project designs. They can also validate their complete project by using the Roxtec CAD symbols and the Roxtec Transit Designer for easy incorporation of transits into the design of the entire ship or vessel.

Always available, everywhere

Roxtec Transit Designer is accessible online. You can share your work with project teams worldwide, and Roxtec experts are always available through the chat function. To start using it, just register on www.roxtec.com.

Features

- Free web-based application, available online
- Simple product selection
- Copy and paste for cable or pipe schedule inputs
- Manufacturer-approved engineering outputs
- Improve project efficiency and flexibility
- Import multiple transits to speed up design work
- Reduce project risks



SIMPLE USER INPUT

Cable/pipe schedule or estimates
Sealing/certification requirements
Installation preferences
Material quality selection

APPROVED OUTPUT

2D drawings in DXF and PDF
3D STEP
Bill of material in Excel
Installation instructions

THE ROXTEC SEALING SYSTEM



Superior flexibility

Roxtec sealing solutions for cables and pipes ensure safety, efficiency and long-term operational reliability in a wide range of marine projects worldwide.

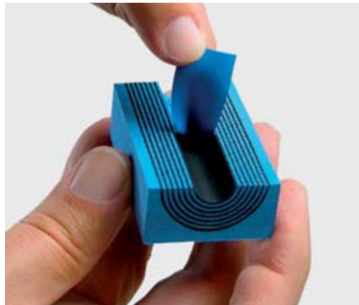

Our invention for adaptability, Multidiameter™, is a solution based on rubber modules with removable layers. It allows for a perfect sealing, regardless of the dimension of the cable or pipe. This flexibility simplifies planning and design, speeds up installation work and reduces the need for stock, material and logistics. It also provides built-in spare capacity for cost-efficient maintenance and future upgrades.

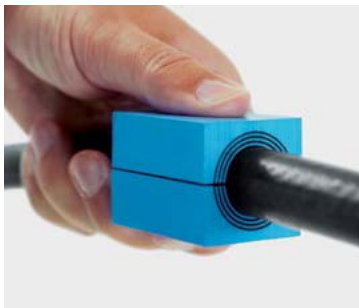

Breaking innovation

The Roxtec solution has revolutionized the design and the process of cable routing and pipe installation. Thanks to Roxtec Multidiameter, each module can handle a number of cable and pipe sizes. It is also possible to add extra capacity from the start. Users can therefore perform their tasks without knowing the size or number of cables or pipes in advance – which reduces engineering hours.

Flexible components

The Roxtec sealing system is a mechanical sealing solution available for various applications, including multiple as well as

single-cable and pipe penetrations. In most Roxtec transits, the sealing modules are inserted around cables or pipes in frames that are welded or bolted to the structure. The frames are available in different shapes, materials and sizes for different applications. The system is sealed with a Roxtec Wedge or an integrated compression unit.

Adaptable modules

The Roxtec system means very few parts. With six basic Roxtec module sizes, you can easily seal cables and pipes from 4 mm to 99 mm in diameter in transits with multiple openings. Standard versions of single penetration seals handle cables or pipes with a diameter of up to 580 mm. There is also a range of modules with different features, in order to cover all your safety needs. There is, for example, the EMC product line. It provides efficient solutions for bonding and grounding of armored and shielded cables as well as for electrical safety in fully shielded environments.



Few parts to make a strong barrier

This is an overview showing how very few components you need to put together a complete Roxtec sealing solution. There are rectangular and round seals available as well as practical kit solutions.

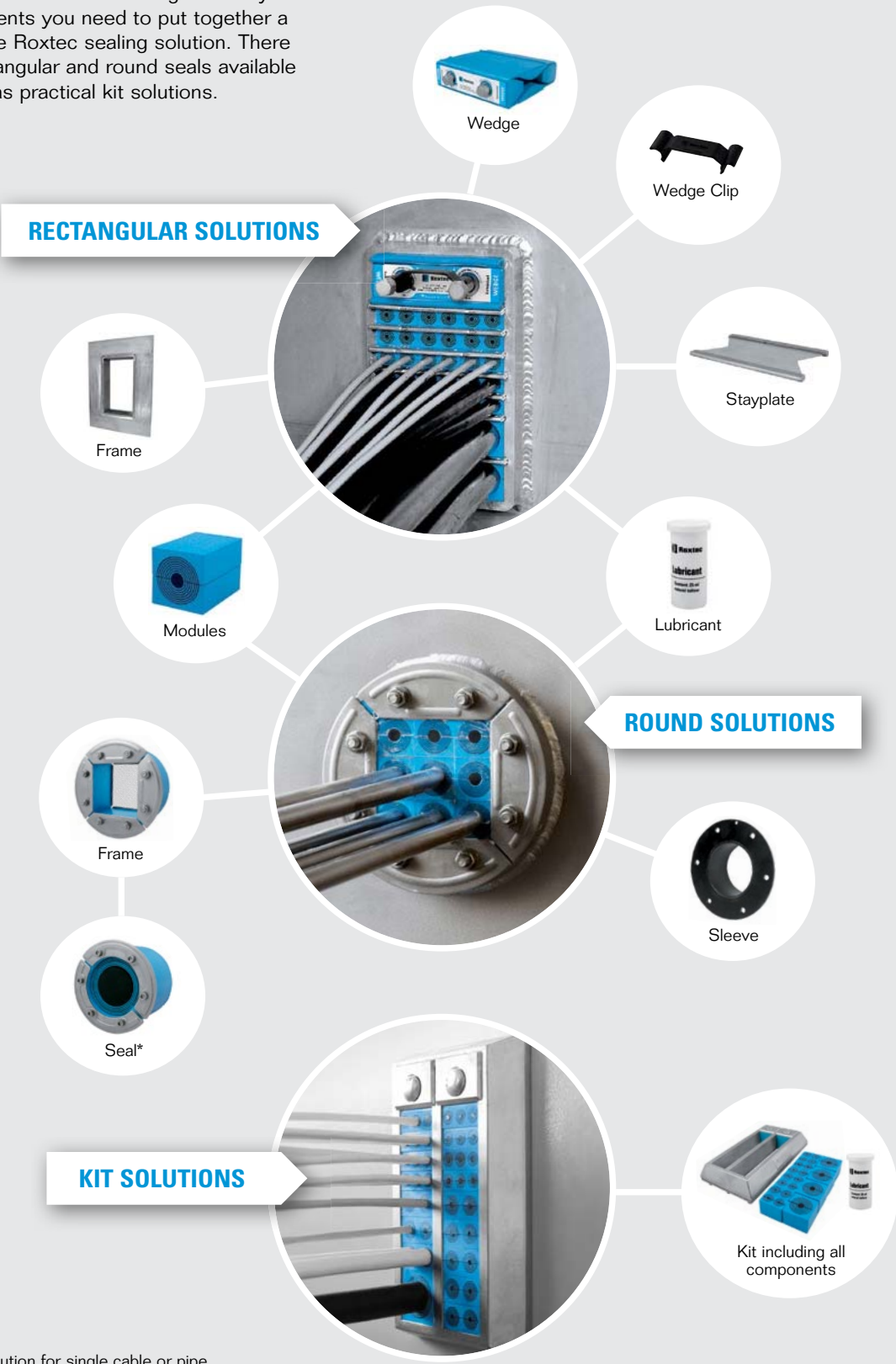

*Seal – solution for single cable or pipe

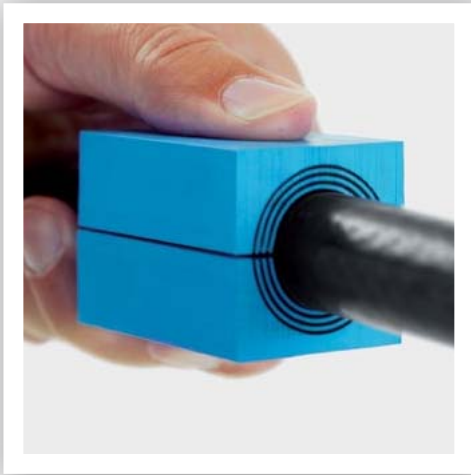

Roxtec modules

Roxtec modules in product group RM are based on 60 mm (2.362") standard depth and used for sealing of cables and pipes in walls, floors, bulkheads and decks. Modules in group CM are based on depths of 15-40 mm (0.591"-1.575"). Areas of use are entry sealing of cables and smaller hoses in cabinets and enclosures. Both groups, RM and CM, are available for the EMC and Ex application areas.

- Roxtec RM modules with Multidiameter™ are adaptable to cables and pipes with OD 3.0-99.0 mm (0.118"-3.898")
- Roxtec CM modules with Multidiameter™ are adaptable to cables and pipes with OD 3.5-34.5 mm (0.138"-1.358")
- When used with a solid core the module functions as a spare module for future capacity needs.

Roxtec RM modules



RM 15



RM 15w40*

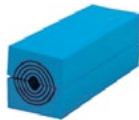

RM 20

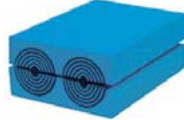

RM 20w40*



RM 30

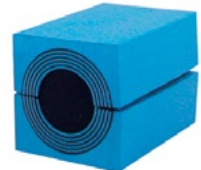

RM 40

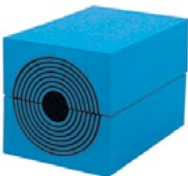

RM 40 10-32

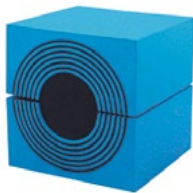

RM 60

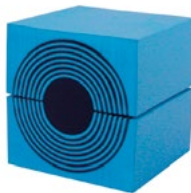

RM 60 24-54



RM 60 woc



RM 80 woc

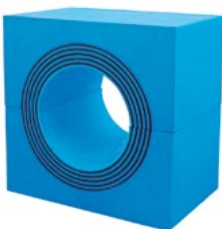

RM 90 woc

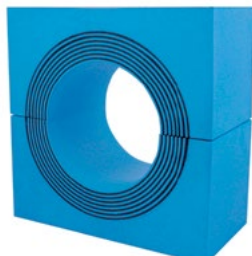

RM 120 woc

Roxtec RM modules

Module	Number of cables/pipes	For cable/pipe diameter		External dim. (mm) HxW (D=60 mm)	Weight (max)		Art. No
		\varnothing_a - \varnothing_b (mm)	\varnothing_a - \varnothing_b (in)		(kg)	(lb)	
WITH CORE							
RM 15	1	0+3.0-11.0	0+0.118-0.433	15x15	0.02	0.044	RM00100151000
RM 15w40*	3	0+3.5-10.5	0+0.138-0.413	15x40	0.05	0.110	RM00115401000
RM 20	1	0+4.0-14.5	0+0.157-0.571	20x20	0.04	0.088	RM00100201000
RM 20w40*	2	0+3.5-16.5	0+0.138-0.650	20x40	0.07	0.154	RM00120401000
RM 30	1	0+10.0-25.0	0+0.394-0.984	30x30	0.08	0.176	RM00100301000
RM 40	1	0+21.5-34.5	0+0.846-1.358	40x40	0.14	0.309	RM00100401000
RM 40 10-32	1	0+9.5-32.5	0+0.374-1.280	40x40	0.14	0.309	RM00140101000
RM 60	1	0+28.0-54.0	0+1.102-2.126	60x60	0.33	0.728	RM00100601000
RM 60 24-54	1	0+24.0-54.0	0+0.945-2.126	60x60	0.33	0.728	RM00160201000
WITHOUT CORE							
RM 60 woc	1	28.0-54.0	1.102-2.126	60x60	0.26	0.573	RM00000601000
RM 80 woc	1	48.0-71.0	1.890-2.795	80x80	0.44	0.970	5RM0000000534
RM 90 woc	1	48.0-71.0	1.890-2.795	90x90	0.56	1.253	RM00000901000
RM 120 woc	1	67.5-99.0	2.657-3.898	120x120	0.94	2.072	RM00001201000

* Smart tip: Whenever possible we recommend choosing twin or triplet modules like RM 20w40 or RM 15w40. Benefits are higher area efficiency per frame opening, quicker installation and improved cost-effectiveness.

Roxtec solid compensation module kits for SRC frames



RM 20/0 RC



RM 40/0 RC

Module	No. of modules/kit	External dim. (mm) HxW (D=60 mm)	Weight per kit		Art. No
			(kg)	(lb)	
RM 20/0 RC	4	20x20	0.13	0.287	RMC0300201000
RM 40/0 RC	4	40x40	0.30	0.661	RMC0300401000

Roxtec RM solid compensation modules



RM 30/0



RM 5/0x24



RM 10/0x12

Module	External dim. (mm) HxW (D=60 mm)	Weight (max)		Art. No
		(kg)	(lb)	
RM 5/0x24	5x120	0.06	0.126	RM00305241000
RM 10/0x12	10x120	0.12	0.256	RM00310121000
RM 15/0	15x15	0.02	0.049	RM00300151000
RM 20/0	20x20	0.04	0.086	RM00300201000
RM 30/0	30x30	0.08	0.179	RM00300301000
RM 40/0	40x40	0.15	0.320	RM00300401000
RM 60/0	60x60	0.33	0.719	RM00300601000

Smart tip: Consider using an RM module rather than a solid module. A Roxtec RM module installed with a solid centre core serves the same purpose as a traditional solid module, but it also provides spare capacity for future installations.

Roxtec CM modules



CM 15w40*

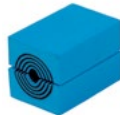

CM 20



CM 20w40*

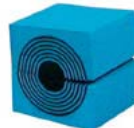

CM 30



CM 30w40

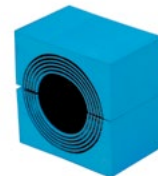

CM 40



CM 40 10-32

Module	Number of cables/pipes	For cable/pipe diameter		External dim. (mm) HxW (D=30 mm)	Weight (max)		Art. No
		\varnothing_a - \varnothing_b (mm)	\varnothing_a - \varnothing_b (in)		(kg)	(lb)	
CM 15w40*	3	0+ 3.5-10.5	0+ 0.138-0.413	15x40	0.03	0.055	C000115401000
CM 20	1	0+ 4.0-14.5	0+ 0.157-0.571	20x20	0.02	0.044	C000100201000
CM 20w40*	2	0+ 3.5-16.5	0+ 0.138-0.650	20x40	0.04	0.077	C000120401000
CM 30	1	0+ 10.0-25.0	0+ 0.394-0.984	30x30	0.04	0.088	C000100301000
CM 30w40	1	0+ 10.0-25.0	0+ 0.394-0.984	30x40	0.06	0.121	C000130401000
CM 40	1	0+21.5-34.5	0+ 0.846-1.358	40x40	0.07	0.135	5CM0000008983
CM 40 10-32	1	0+ 9.5-32.5	0+ 0.374-1.280	40x40	0.07	0.135	C000140101000

* Smart tip: Whenever possible we recommend choosing twin or triplet modules like CM 20w40 or CM 15w40. Benefits are higher area efficiency per frame opening, quicker installation and improved cost-effectiveness.

Roxtec CM solid compensation modules

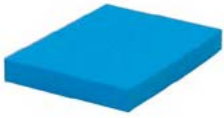

CM 5w40/0*

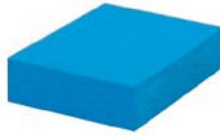

CM 10w40/0*

Module	External dim. (mm) HxW (D=30 mm)	Weight (max)		Art. No
		(kg)	(lb)	
CM 5w40/0	5x40	0.01	0.022	C000305401000
CM 10w40/0	10x40	0.02	0.044	C000310401000

* Smart tip: Consider using a CM module rather than a solid module. A Roxtec CM module installed with a solid centre core serves the same purpose as a traditional solid module, but it also provides spare capacity for future installations.

Roxtec RM modules, technical information

RM modules

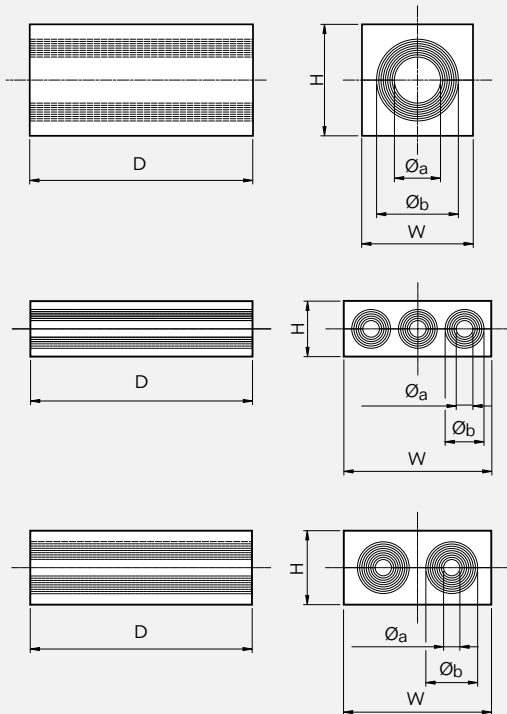

Pos	(mm)	(in)
Ø _a	Min. cable/pipe diameter	
Ø _b	Max. cable/pipe diameter	
D	60 mm	2.362"

Note: All dimensions are nominal values

Solid corner compensation module for SRC frames

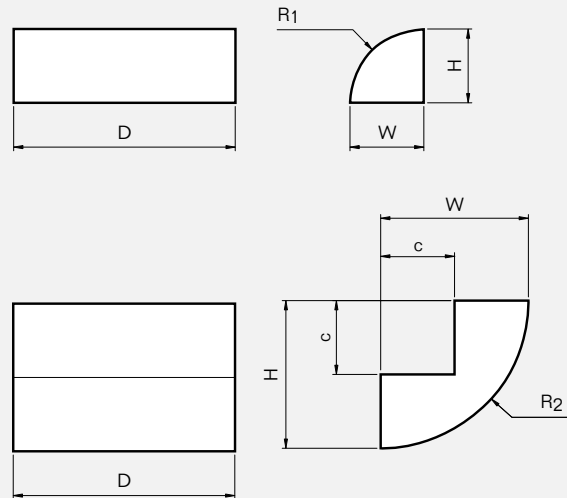

Pos	(mm)	(in)
R ₁	R 20	R 0.787
R ₂	R 40	R 1.575
c	20	0.787
D	60	2.362

Note: All dimensions are nominal values

Roxtec RM solid compensation modules, technical information

Pos	(mm)	(in)
D	60	2.362

Note: All dimensions are nominal values

Roxtec CM modules, technical information

CM modules

Pos	(mm)	(in)
\varnothing_a	Min. cable/pipe diameter	
\varnothing_b	Max. cable/pipe diameter	
D	30 mm	1.181"

Note: All dimensions are nominal values

CM solid compensation modules

Pos	(mm)	(in)
D	30	1.181

Note: All dimensions are nominal values

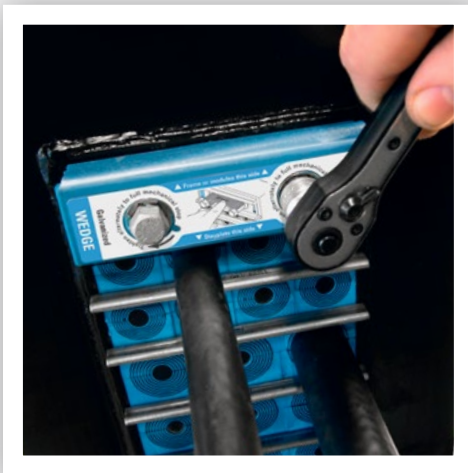

Roxtec Wedges

Roxtec Wedges are used in frames with a rectangular packing space without built-in compression to compress and seal the installation of cables, pipes, modules and stayplates.

- The Roxtec Wedge is for use with Group RM frames and components
- The Roxtec C Wedge is for use with Group CM frames and components

Wedge kit/parts, galvanized



Wedge kit galv



Wedge 120 galv



Wedge 60 galv

Wedge	External dimensions		Weight		Art. No
	W (mm)	W (in)	(kg)	(lb)	
Wedge kit galv*	(wedge) 120	(wedge) 4.724	1.5	3.307	AWK0001201018
Wedge 120 galv	120	4.724	0.8	1.764	ARW0001201018
Wedge 60 galv	60	2.362	0.4	0.882	ARW0000601018

* The Wedge kit includes one Roxtec Wedge 120, five stayplates, one Wedge Clip, one lubricant and installation instructions.

Wedge kit/parts, acid-proof stainless steel



Wedge	External dimensions		Weight		Art. No
	W (mm)	W (in)	(kg)	(lb)	
Wedge kit AISI 316*	(wedge) 120	(wedge) 4.724	1.5	3.307	AWK0001201021
Wedge 120 AISI 316	120	4.724	0.8	1.764	ARW0001201021
Wedge 60 AISI 316	60	2.362	0.4	0.882	ARW000601021

* The Wedge kit includes one Roxtec Wedge 120, five stayplates, one Wedge Clip, one lubricant and installation instructions.

C Wedge kit/parts, galvanized



Wedge	External dimensions		Weight		Art. No
	W (mm)	W (in)	(kg)	(lb)	
C Wedge kit galv*	120	4.724	0.65	1.443	AWK2001201018
C Wedge 120 galv	120	4.724	0.40	0.882	CRW0001201018

* The Wedge kit includes one Roxtec C Wedge 120, six C stayplates, one lubricant and installation instructions.

C Wedge kit/parts, acid-proof stainless steel



C Wedge kit AISI 316



C Wedge 120 AISI 316

Wedge	External dimensions		Weight		Art. No
	W (mm)	W (in)	(kg)	(lb)	
C Wedge kit AISI 316*	120	4.724	0.65	1.443	AWK2001201021
C Wedge 120 AISI 316	120	4.724	0.40	0.882	5crw000011340

* The Wedge kit includes one Roxtec C Wedge 120, six C stayplates, one lubricant and installation instructions.

Wedge, technical information

Wedge

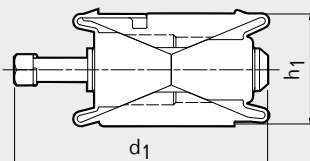

Compressed

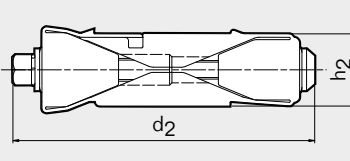

Uncompressed

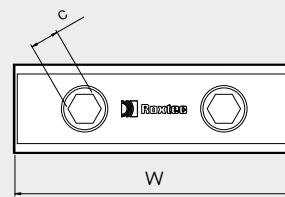

Wedge 120

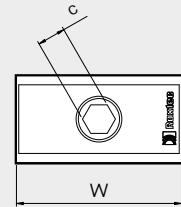

Wedge 60

C Wedge

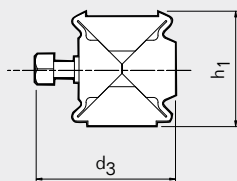

Compressed

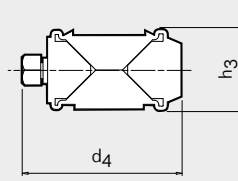

Uncompressed

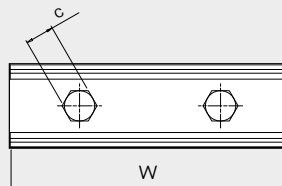

C Wedge 120

Pos	(mm)	(in)
d ₁	109	4.291
d ₂	130	5.118
d ₃	61	2.402
d ₄	70	2.756
h ₁	48	1.890
h ₂	29	1.142
h ₃	32	1.260
c	SW 13	SW 0.512

Note: All dimensions are nominal values

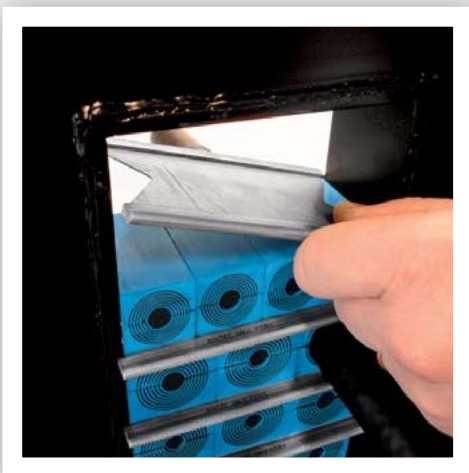

Roxtec Stayplates

Roxtec Stayplates provide mechanical anchorage for the modules in order to keep them in the frame and protect against blow-outs. To be inserted between rows of modules in frames with a rectangular packing space and no built-in compression.

- The Roxtec Stayplate is for use with Group RM frames and components
- The Roxtec C Stayplate is for use with Group CM frames and components

Stayplate



Stayplate 120 galv



Stayplate 60 galv



Stayplate 120 AISI 316



Stayplate 60 AISI 316



Stayplate 120 ALU



Stayplate 60 ALU

Stayplate	Fits packing space		Weight		Art. No
	W (mm)	W (in)	(kg)	(lb)	
Stayplate 120 galv	120	4.724	0.1	0.243	ASP0001200018
Stayplate 60 galv	60	2.362	0.06	0.132	ASP0000600018
Stayplate 120 AISI 316	120	4.724	0.1	0.243	ASP0001200021
Stayplate 60 AISI 316	60	2.362	0.06	0.132	ASP0000600021
Stayplate 120 ALU	120	4.724	0.04	0.088	ASP0001200031
Stayplate 60 ALU	60	2.362	0.02	0.044	ASP0000600031

C Stayplate



C Stayplate 120 galv



C Stayplate 120 AISI 316

Stayplate	Fits packing space		Weight		Art. No
	W (mm)	W (in)	(kg)	(lb)	
C Stayplate 120 galv	120	4.724	0.02	0.051	ASP2001200018
C Stayplate 120 AISI 316	120	4.724	0.02	0.051	ASP3001200021

Stayplate, technical information

Stayplate 120

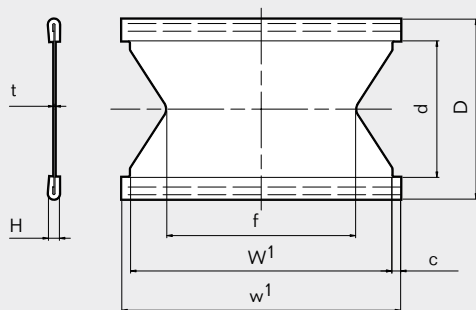

Pos	(mm)	(in)
c	4	0.157
d	62	2.499
e	26	1.024
f	86	3.386
t	0.5	0.020
D	82	3.228
H	5	0.197
W ¹	119	4.685
w ¹	127	5.000
W ²	59	2.323
w ²	67	2.638

Stayplate 60

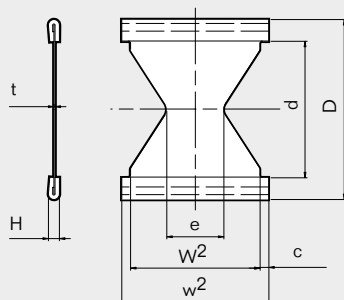

galv Galvanized

AISI 316 Acid-proof stainless steel

ALU Aluminum

Note: All dimensions are nominal values



Roxtec Lubricant/ Roxtec Assembly Gel

The lubricant is natural tallow used to lubricate the sealing modules, the Roxtec Wedge and the inside of the frame. This provides correct compression and a secure seal. The assembly gel is intended for Roxtec ComSeal™ LW and Roxtec ComSeal™.

Roxtec Lubricant



Lubricant 10 ml



Lubricant 25 ml

Lubricant	Art. No
Lubricant 10 ml	ALT0000001000
Lubricant 25 ml	ALT0000003000

Roxtec Assembly Gel



Assembly Gel 30 ml



Assembly Gel Bag 10 ml

Assembly Gel	Art. No
Assembly Gel 30 ml	ALT0000004000
Assembly Gel Bag 10 ml	ALT0000005000

CABLE ENTRY SOLUTIONS



Regular frames and seals

Roxtec regular cable transits for decks, bulkheads, floors and walls are successfully used in the ship-building industry since 1990.

Roxtec regular frames are available in different designs and materials, such as mild steel, stainless steel and aluminum, and they can be attached either through bolting, welding or fitting into sleeves. The depth of the frames is normally 60 mm (2.362"), and they are filled with standard RM modules of the same depth. Together the modules cover a cable diameter range of 3 to 99 mm (0.118"-3.898"). To complete the installation and seal the transit, you also need lubricant, stayplates and a wedge. The seals are also available for use in EMC and Ex applications.





Roxeltec S frame

Roxeltec S frame is a metal frame available with a single opening, or in combinations with several openings in width and/or height.

- For use with Group RM components
- Attachment by welding

S frame, primed mild steel



S 6x1 primed

See parts needed for a complete solution on page 26.

See installation instructions on page 222.

See practical user guidelines on page 264.

Remove primer from the inside of the frame to ensure good conductivity in EMC applications.

For information about other frame combinations, or for openable versions of this frame, please contact your local Roxeltec supplier or e-mail: info@roxtec.com

RATINGS Fire: A class, H class Water pressure: 4 bar Gas pressure: 2.5 bar

Frame	Frame openings	Packing space (mm)	External dimensions (D=60 mm)		Weight		Art. No
			HxW (mm)	HxW (in)	(kg)	(lb)	
S 1x1 primed	1	60 x 60	121 x 80	4.764 x 3.150	1.6	3.527	SS01000000112
S 2x1 primed	1	60 x 120	121 x 141	4.764 x 5.551	2.2	4.938	S002000000112
S 2x2 primed	2	60 x 120	121 x 271	4.764 x 10.669	3.9	8.488	S002000000212
S 2x3 primed	3	60 x 120	121 x 402	4.764 x 15.827	5.5	12.037	S002000000312
S 2x4 primed	4	60 x 120	121 x 532	4.764 x 20.945	7.1	15.609	S002000000412
S 2x5 primed	5	60 x 120	121 x 663	4.764 x 26.102	8.7	19.158	S002000000512
S 2x6 primed	6	60 x 120	121 x 793	4.764 x 31.220	10.3	22.707	S002000000612
S 3x1 primed	1	120 x 60	180 x 80	7.087 x 3.150	2.3	5.071	SS03000000112

S frame, primed mild steel

Frame	Frame openings	Packing space (mm)	External dimensions (D=60 mm)		Weight		Art. No
			HxW (mm)	HxW (in)	(kg)	(lb)	
S 4x1 primed	1	120 x 120	180 x 141	7.087 x 5.551	2.8	6.151	S004000000112
S 4x2 primed	2	120 x 120	180 x 271	7.087 x 10.669	4.7	10.318	S004000000212
S 4x3 primed	3	120 x 120	180 x 402	7.087 x 15.827	6.6	14.484	S004000000312
S 4x4 primed	4	120 x 120	180 x 532	7.087 x 20.945	8.5	18.629	S004000000412
S 4x5 primed	5	120 x 120	180 x 663	7.087 x 26.102	10.3	22.796	S004000000512
S 4x6 primed	6	120 x 120	180 x 793	7.087 x 31.220	12.2	26.962	S004000000612
S 4x7 primed	7	120 x 120	180 x 924	7.087 x 36.378	14.1	31.129	S004000000712
S 4x8 primed	8	120 x 120	180 x 1054	7.087 x 41.496	16.0	35.296	S004000000812
S 4x9 primed	9	120 x 120	180 x 1185	7.087 x 46.654	17.9	39.440	S004000000912
S 4+4x1 primed	2	120 x 120	349 x 141	13.740 x 5.551	5.0	11.067	S004400000112
S 4+4x2 primed	4	120 x 120	359 x 271	14.134 x 10.669	9.5	20.878	S004400000212
S 4+4x3 primed	6	120 x 120	359 x 402	14.134 x 15.827	13.5	29.321	S004400000312
S 4+4x4 primed	8	120 x 120	359 x 532	14.134 x 20.945	17.1	37.743	S004400000412
S 4+4x5 primed	10	120 x 120	359 x 663	14.134 x 26.102	21.0	46.186	S004400000512
S 4+4x6 primed	12	120 x 120	359 x 793	14.134 x 31.220	24.8	54.630	S004400000612
S 4+4x7 primed	14	120 x 120	359 x 924	14.134 x 36.378	28.6	63.096	S004400000712
S 4+4x8 primed	16	120 x 120	359 x 1054	14.134 x 41.496	32.6	71.539	S004400000812
S 4+4+4x1 primed	3	120 x 120	519 x 141	20.433 x 5.551	6.6	14.550	S004440000112
S 4+4+4x2 primed	6	120 x 120	539 x 271	21.220 x 10.669	14.2	31.305	S004440000212
S 4+4+4x3 primed	9	120 x 120	539 x 402	21.220 x 15.827	19.9	43.872	S004440000312
S 4+4+4x4 primed	12	120 x 120	539 x 532	21.220 x 20.945	26.2	57.761	S004440000412
S 4+4+4x5 primed	15	120 x 120	539 x 663	21.220 x 26.102	31.3	69.004	S004440000512
S 4+4+4x6 primed	18	120 x 120	539 x 793	21.220 x 31.220	37.0	81.570	S004440000612
S 5x1 primed	1	180 x 60	238 x 80	9.370 x 3.150	2.8	6.173	SS05000000112
S 6x1 primed	1	180 x 120	238 x 141	9.370 x 5.551	3.3	7.363	S006000000112
S 6x2 primed	2	180 x 120	238 x 271	9.370 x 10.669	5.5	12.147	S006000000212
S 6x3 primed	3	180 x 120	238 x 402	9.370 x 15.827	7.7	16.909	S006000000312
S 6x4 primed	4	180 x 120	238 x 532	9.370 x 20.945	9.8	21.671	S006000000412
S 6x5 primed	5	180 x 120	238 x 663	9.370 x 26.102	12.0	26.455	S006000000512
S 6x6 primed	6	180 x 120	238 x 793	9.370 x 31.220	14.2	31.217	S006000000612
S 6x7 primed	7	180 x 120	238 x 924	9.370 x 36.378	16.3	35.979	S006000000712
S 6x8 primed	8	180 x 120	238 x 1054	9.370 x 41.496	18.5	40.763	S006000000812
S 6x9 primed	9	180 x 120	238 x 1185	9.370 x 46.654	20.7	45.525	S006000000912
S 6+6x1 primed	2	180 x 120	466 x 141	18.346 x 5.551	6.1	13.492	S006600000112
S 6+6x2 primed	4	180 x 120	476 x 271	18.740 x 10.669	11.1	24.537	S006600000212
S 6+6x3 primed	6	180 x 120	476 x 402	18.740 x 15.827	15.5	34.171	S006600000312
S 6+6x4 primed	8	180 x 120	476 x 532	18.740 x 20.945	19.9	43.827	S006600000412
S 6+6x5 primed	10	180 x 120	476 x 663	18.740 x 26.102	24.3	53.506	S006600000512

S frame, primed mild steel

Frame	Frame openings	Packing space (mm)	External dimensions (D=60 mm)		Weight		Art. No
			HxW (mm)	HxW (in)	(kg)	(lb)	
S 6+6x6 primed	12	180 x 120	476 x 793	18.740 x 31.220	28.6	63.140	S006600000612
S 6+6x7 primed	14	180 x 120	476 x 924	18.740 x 36.378	33.0	72.796	S006600000712
S 6+6x8 primed	16	180 x 120	476 x 1054	18.740 x 41.496	37.4	82.474	S006600000812
S 6+6x9 primed	18	180 x 120	476 x 1185	18.740 x 46.654	41.8	92.108	S006600000912
S 6+6x10 primed	20	180 x 120	476 x 1315	18.740 x 51.772	46.2	101.764	S006600001012
S 6+6+6x1 primed	3	180 x 120	694 x 141	27.323 x 5.551	8.2	18.078	S006660000112
S 7x1 primed	1	240 x 60	298 x 80	11.732 x 3.150	3.3	7.363	SS07000000112
S 8x1 primed	1	240 x 120	298 x 141	11.732 x 5.551	3.9	8.620	S008000000112
S 8x2 primed	2	240 x 120	298 x 271	11.732 x 10.669	6.1	13.382	S008000000212
S 8x3 primed	3	240 x 120	298 x 402	11.732 x 15.827	8.2	18.144	S008000000312
S 8x4 primed	4	240 x 120	298 x 532	11.732 x 20.945	10.4	22.928	S008000000412
S 8x5 primed	5	240 x 120	298 x 663	11.732 x 26.102	12.6	27.690	S008000000512
S 8x6 primed	6	240 x 120	298 x 793	11.732 x 31.220	14.7	32.452	S008000000612
S 8+8x1 primed	2	240 x 120	586 x 141	23.071 x 5.551	7.3	16.005	S008800000112
S 8+8x2 primed	4	240 x 120	596 x 271	23.465 x 10.669	12.3	27.006	S008800000212
S 8+8x3 primed	6	240 x 120	596 x 402	23.465 x 15.827	16.6	36.640	S008800000312
S 8+8x4 primed	8	240 x 120	596 x 532	23.465 x 20.945	21.0	46.341	S008800000412
S 8+8x5 primed	10	240 x 120	596 x 663	23.465 x 26.102	25.4	55.975	S008800000512
S 8+8x6 primed	12	240 x 120	596 x 793	23.465 x 31.220	29.8	65.609	S008800000612
S 8+8x7 primed	14	240 x 120	596 x 924	23.465 x 36.378	34.2	75.309	S008800000712
S 8+8x8 primed	16	240 x 120	596 x 1054	23.465 x 41.496	38.5	84.943	S008800000812
S 8+8x9 primed	18	240 x 120	596 x 1185	23.465 x 46.654	42.9	94.577	S008800000912
S 8+8x10 primed	20	240 x 120	596 x 1315	23.465 x 51.772	47.3	104.278	S008800001012
S 8+8+8x1 primed	3	240 x 120	874 x 141	34.409 x 5.551	9.9	21.826	S008880000112

S frame, acid-proof stainless steel



S 6x1 AISI 316

See parts needed for a complete solution on page 26.

See installation instructions on page 222.

See practical user guidelines on page 264.

For information about other frame combinations, or for openable versions of this frame, please contact your local Roxtec supplier or e-mail: info@roxtec.com

RATINGS							
Fire: A class, H class		Water pressure: 4 bar		Gas pressure: 2.5 bar			
Frame	Frame openings	Packing space (mm)	External dimensions (D=60 mm)		Weight		Art. No
			HxW (mm)	HxW (in)	(kg)	(lb)	
S 2x1 AISI 316	1	60 x 120	121 x 141	4.764 x 5.551	2.2	4.938	S002000000121
S 2x2 AISI 316	2	60 x 120	121 x 271	4.764 x 10.669	3.9	8.488	S002000000221
S 2x3 AISI 316	3	60 x 120	121 x 402	4.764 x 15.827	5.5	12.037	S002000000321
S 2x4 AISI 316	4	60 x 120	121 x 532	4.764 x 20.945	7.1	15.609	S002000000421
S 2x5 AISI 316	5	60 x 120	121 x 663	4.764 x 26.102	8.7	19.158	S002000000521
S 2x6 AISI 316	6	60 x 120	121 x 793	4.764 x 31.220	10.3	22.707	S002000000621
S 4x1 AISI 316	1	120 x 120	180 x 141	7.087 x 5.551	2.8	6.151	S004000000121
S 4x2 AISI 316	2	120 x 120	180 x 271	7.087 x 10.669	4.7	10.318	S004000000221
S 4x3 AISI 316	3	120 x 120	180 x 402	7.087 x 15.827	6.6	14.484	S004000000321
S 4x4 AISI 316	4	120 x 120	180 x 532	7.087 x 20.945	8.5	18.629	S004000000421
S 4x5 AISI 316	5	120 x 120	180 x 663	7.087 x 26.102	10.3	22.796	S004000000521
S 4x6 AISI 316	6	120 x 120	180 x 793	7.087 x 31.220	12.2	26.962	S004000000621
S 4+4x1 AISI 316	2	120 x 120	349 x 141	13.740 x 5.551	5.0	11.067	S004400000121
S 4+4+4x1 AISI 316	3	120 x 120	519 x 141	20.433 x 5.551	6.6	14.550	S004440000121
S 6x1 AISI 316	1	180 x 120	238 x 141	9.370 x 5.551	3.3	7.363	S006000000121
S 6x2 AISI 316	2	180 x 120	238 x 271	9.370 x 10.669	5.5	12.147	S006000000221
S 6x3 AISI 316	3	180 x 120	238 x 402	9.370 x 15.827	7.7	16.909	S006000000321
S 6x4 AISI 316	4	180 x 120	238 x 532	9.370 x 20.945	9.8	21.671	S006000000421
S 6x5 AISI 316	5	180 x 120	238 x 663	9.370 x 26.102	12.0	26.455	S006000000521
S 6x6 AISI 316	6	180 x 120	238 x 793	9.370 x 31.220	14.2	31.217	S006000000621
S 6+6x1 AISI 316	2	180 x 120	466 x 141	18.346 x 5.551	6.1	13.492	S006600000121
S 6+6x2 AISI 316	4	180 x 120	476 x 271	18.740 x 10.669	11.1	24.537	S006600000221
S 6+6x3 AISI 316	6	180 x 120	476 x 402	18.740 x 15.827	15.5	34.171	S006600000321
S 6+6x4 AISI 316	8	180 x 120	476 x 532	18.740 x 20.945	19.9	43.872	S006600000421
S 6+6x5 AISI 316	10	180 x 120	476 x 663	18.740 x 26.102	24.3	53.506	S006600000521
S 6+6x6 AISI 316	12	180 x 120	476 x 793	18.740 x 31.220	28.6	63.140	S006600000621

S frame, acid-proof stainless steel

Frame	Frame openings	Packing space (mm)	External dimensions (D=60 mm)		Weight		Art. No
			HxW (mm)	HxW (in)	(kg)	(lb)	
S 8x1 AISI 316	1	240 x 120	298 x 141	11.732 x 5.551	3.9	8.620	S008000000121
S 8x2 AISI 316	2	240 x 120	298 x 271	11.732 x 10.669	6.1	13.382	S008000000221
S 8x3 AISI 316	3	240 x 120	298 x 402	11.732 x 15.827	8.2	18.144	S008000000321
S 8x4 AISI 316	4	240 x 120	298 x 532	11.732 x 20.945	10.4	22.928	S008000000421
S 8x5 AISI 316	5	240 x 120	298 x 663	11.732 x 26.102	12.6	27.690	S008000000521
S 8x6 AISI 316	6	240 x 120	298 x 793	11.732 x 31.220	14.7	32.452	S008000000621
S 8+8x1 AISI 316	2	240 x 120	586 x 141	23.071 x 5.551	7.3	16.005	S008800000121
S 8+8+8x1 AISI 316	3	240 x 120	874 x 141	34.409 x 5.551	9.9	21.826	S008880000121

S frame, aluminum



S 6x1 ALU

See parts needed for a complete solution on page 26.

See installation instructions on page 222.

See practical user guidelines on page 264.

For information about other frame combinations, or for openable versions of this frame, please contact your local Roxtec supplier or e-mail: info@roxtec.com

RATINGS

Fire: A class, H class

Water pressure: 4 bar

Gas pressure: 2.5 bar

Frame	Frame openings	Packing space (mm)	External dimensions (D=60 mm)		Weight		Art. No
			HxW (mm)	HxW (in)	(kg)	(lb)	
S 2x1 ALU	1	60 x 120	121 x 141	4.764 x 5.551	0.8	1.698	S002000000131
S 2x2 ALU	2	60 x 120	121 x 271	4.764 x 10.669	1.3	2.910	S002000000231
S 2x3 ALU	3	60 x 120	121 x 402	4.764 x 15.827	1.9	4.145	S002000000331
S 2x4 ALU	4	60 x 120	121 x 532	4.764 x 20.945	2.4	5.357	S002000000431
S 2x5 ALU	5	60 x 120	121 x 663	4.764 x 26.102	3.0	6.592	S002000000531
S 2x6 ALU	6	60 x 120	121 x 793	4.764 x 31.220	3.5	7.804	S002000000631
S 2+2x1 ALU	2	60 x 120	232 x 141	9.134 x 5.551	1.3	2.965	S002200000131
S 2+2+2x1 ALU	3	60 x 120	343 x 141	13.504 x 5.551	1.7	3.748	S002220000131
S 4x1 ALU	1	120 x 120	180 x 141	7.087 x 5.551	1.0	2.116	S004000000131
S 4x2 ALU	2	120 x 120	180 x 271	7.087 x 10.669	1.6	3.549	S004000000231
S 4x3 ALU	3	120 x 120	180 x 402	7.087 x 15.827	2.3	4.982	S004000000331

S frame, aluminum

Frame	Frame openings	Packing space (mm)	External dimensions (D=60 mm)		Weight		Art. No
			HxW (mm)	HxW (in)	(kg)	(lb)	
S 4x4 ALU	4	120 x 120	180 x 532	7.087 x 20.945	2.9	6.415	S004000000431
S 4x5 ALU	5	120 x 120	180 x 663	7.087 x 26.102	3.6	7.848	S004000000531
S 4x6 ALU	6	120 x 120	180 x 793	7.087 x 31.220	4.2	9.281	S004000000631
S 4+4x1 ALU	2	120 x 120	349 x 141	13.740 x 5.551	1.7	3.762	S004400000131
S 4+4x2 ALU	4	120 x 120	359 x 271	14.134 x 10.669	3.2	7.099	S004400000231
S 4+4x3 ALU	6	120 x 120	359 x 402	14.134 x 15.827	4.5	9.965	S004400000331
S 4+4x4 ALU	8	120 x 120	359 x 532	14.134 x 20.495	5.8	12.831	S004400000431
S 4+4+4x1 ALU	3	120 x 120	519 x 141	20.433 x 5.551	2.3	5.071	S004440000131
S 6x1 ALU	1	180 x 120	238 x 141	9.370 x 5.551	1.2	2.535	S006000000131
S 6x2 ALU	2	180 x 120	238 x 271	9.370 x 10.669	1.9	4.167	S006000000231
S 6x3 ALU	3	180 x 120	238 x 402	9.370 x 15.827	2.6	5.820	S006000000331
S 6x4 ALU	4	180 x 120	238 x 532	9.370 x 20.495	3.4	7.452	S006000000431
S 6x5 ALU	5	180 x 120	238 x 663	9.370 x 26.102	4.1	9.083	S006000000531
S 6x6 ALU	6	180 x 120	238 x 793	9.370 x 31.220	4.9	10.736	S006000000631
S 6+6x1 ALU	2	180 x 120	466 x 141	18.346 x 5.551	2.1	4.630	S006600000131
S 6+6x2 ALU	4	180 x 120	476 x 271	18.740 x 10.669	3.8	8.333	S006600000231
S 6+6x3 ALU	6	180 x 120	476 x 402	18.740 x 15.827	5.3	11.640	S006600000331
S 6+6x4 ALU	8	180 x 120	476 x 532	18.740 x 20.495	6.8	14.903	S006600000431
S 6+6x5 ALU	10	180 x 120	476 x 663	18.740 x 26.102	8.2	18.166	S006600000531
S 6+6x6 ALU	12	180 x 120	476 x 793	18.740 x 31.220	9.7	21.473	S006600000631
S 6+6+6x1 ALU	3	180 x 120	694 x 141	27.323 x 5.551	2.8	6.173	S006660000131
S 8x1 ALU	1	240 x 120	298 x 141	11.732 x 5.551	1.3	2.954	S008000000131
S 8x2 ALU	2	240 x 120	298 x 271	11.732 x 10.669	2.2	4.806	S008000000231
S 8x3 ALU	3	240 x 120	298 x 402	11.732 x 15.872	3.0	6.658	S008000000331
S 8x4 ALU	4	240 x 120	298 x 532	11.732 x 20.495	3.9	8.532	S008000000431
S 8x5 ALU	5	240 x 120	298 x 663	11.732 x 26.102	4.7	10.385	S008000000531
S 8x6 ALU	6	240 x 120	298 x 793	11.732 x 31.220	5.6	12.236	S008000000631
S 8+8x1 ALU	2	240 x 120	586 x 141	23.071 x 5.551	2.5	5.467	S008800000131
S 8+8+8x1 ALU	3	240 x 120	874 x 141	34.409 x 5.551	3.4	7.496	S008880000131

S frame, technical information

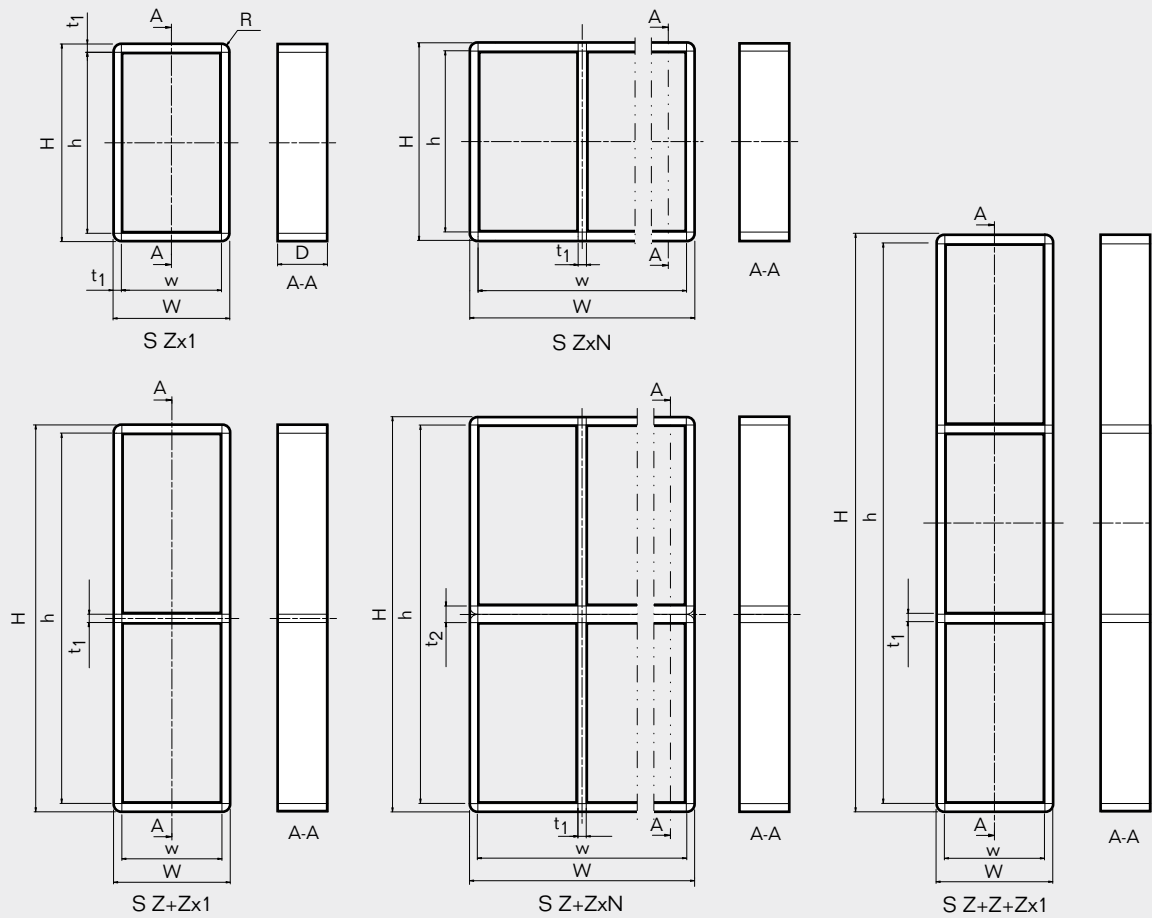

Pos	(mm)	(in)
h	H - 20	H - 0.787
w	W - 20	W - 0.787
D	60	2.362
t ₁	10	0.394
t ₂	20	0.787
R	R 10	R 0.394

Z = Frame size
 N = Number of horizontal openings

Note: All dimensions are nominal values

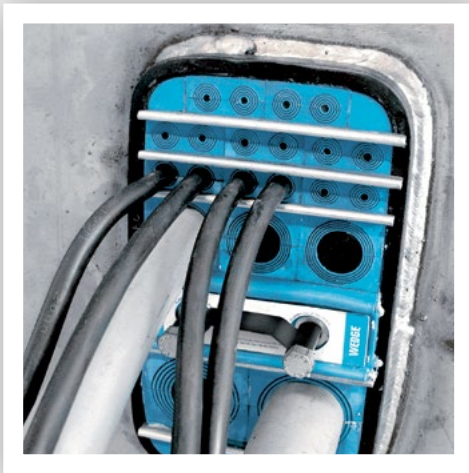

Roxtec SRC frame

The Roxtec SRC frame is a metal frame intended for load bearing structures. Designed with rounded corners to reduce stress concentration and the risk of cracks around the frame. Available in two standard versions, SRC r20 and SRC r40.

- For use with Group RM components
- Attachment by welding

SRC frame, corner radius 20 mm, primed mild steel



SRC 6x1 r20 primed

See parts needed for a complete solution on page 26.

See installation instructions on page 226.

See practical user guidelines on page 264.

For information about other frame combinations, please contact your local Roxtec supplier or e-mail: info@roxtec.com

RATINGS Fire: A class, H class Water pressure: 4 bar Gas pressure: 2.5 bar

Frame	Frame openings	Packing space* (mm)	External dimensions		Weight		Art. No
			HxW (mm)	HxW (in)	(kg)	(lb)	
SRC 2x1 r20 primed	1	60 x 120	121 x 141	4.764 x 5.551	2.2	4.938	SRC2000020112
SRC 2x2 r20 primed	2	60 x 120	121 x 271	4.764 x 10.669	3.9	8.488	SRC2000020212
SRC 2x3 r20 primed	3	60 x 120	121 x 402	4.764 x 15.827	5.5	12.037	SRC2000020312
SRC 2x4 r20 primed	4	60 x 120	121 x 532	4.764 x 20.945	7.1	15.609	SRC2000020412
SRC 2x5 r20 primed	5	60 x 120	121 x 663	4.764 x 26.102	8.7	19.158	SRC2000020512
SRC 2x6 r20 primed	6	60 x 120	121 x 793	4.764 x 31.220	10.3	22.707	SRC2000020612
SRC 4x1 r20 primed	1	120 x 120	180 x 141	7.077 x 5.551	2.8	6.151	SRC4000020112
SRC 4x2 r20 primed	2	120 x 120	180 x 271	7.077 x 10.669	4.7	10.318	SRC4000020212

SRC frame, corner radius 20 mm, primed mild steel

Frame	Frame openings	Packing space* (mm)	External dimensions		Weight		Art. No
			HxW (mm)	HxW (in)	(kg)	(lb)	
SRC 4x3 r20 primed	3	120 x 120	180 x 402	7.077 x 15.827	6.6	14.484	SRC4000020312
SRC 4x4 r20 primed	4	120 x 120	180 x 532	7.077 x 20.945	8.5	18.629	SRC4000020412
SRC 4x5 r20 primed	5	120 x 120	180 x 663	7.077 x 26.102	10.3	22.796	SRC4000020512
SRC 4x6 r20 primed	6	120 x 120	180 x 793	7.077 x 31.220	12.2	26.962	SRC4000020612
SRC 4x7 r20 primed	7	120 x 120	180 x 924	7.077 x 36.378	14.1	31.129	SRC4000020712
SRC 4x8 r20 primed	8	120 x 120	180 x 1054	7.077 x 41.496	16.0	35.296	SRC4000020812
SRC 4x9 r20 primed	9	120 x 120	180 x 1185	7.077 x 46.654	17.9	39.440	SRC4000020912
SRC 6x1 r20 primed	1	180 x 120	238 x 141	9.370 x 5.551	3.3	7.363	SRC6000020112
SRC 6x2 r20 primed	2	180 x 120	238 x 271	9.370 x 10.669	5.5	12.147	SRC6000020212
SRC 6x3 r20 primed	3	180 x 120	238 x 402	9.370 x 15.827	7.7	16.909	SRC6000020312
SRC 6x4 r20 primed	4	180 x 120	238 x 532	9.370 x 20.945	9.8	21.671	SRC6000020412
SRC 6x5 r20 primed	5	180 x 120	238 x 663	9.370 x 26.102	12.0	26.455	SRC6000020512
SRC 6x6 r20 primed	6	180 x 120	238 x 793	9.370 x 31.220	14.2	31.217	SRC6000020612
SRC 6x7 r20 primed	7	180 x 120	238 x 924	9.370 x 36.378	16.3	35.979	SRC6000020712
SRC 6x8 r20 primed	8	180 x 120	238 x 1054	9.370 x 41.496	18.5	40.763	SRC6000020812
SRC 6x9 r20 primed	9	180 x 120	238 x 1185	9.370 x 45.654	20.8	45.525	SRC6000020912
SRC 8x1 r20 primed	1	240 x 120	298 x 141	11.732 x 5.551	3.9	8.620	SRC8000020112
SRC 8x2 r20 primed	2	240 x 120	298 x 271	11.732 x 10.669	6.1	13.382	SRC8000020212
SRC 8x3 r20 primed	3	240 x 120	298 x 402	11.732 x 15.827	8.2	18.144	SRC8000020312
SRC 8x4 r20 primed	4	240 x 120	298 x 532	11.732 x 20.945	10.4	22.928	SRC8000020412
SRC 8x5 r20 primed	5	240 x 120	298 x 663	11.732 x 26.102	12.6	27.690	SRC8000020512
SRC 8x6 r20 primed	6	240 x 120	298 x 793	11.732 x 31.220	14.7	32.452	SRC8000020612

* Please note that the corner radius reduces actual packing space for SRC frames.

SRC frame, corner radius 20 mm, technical information

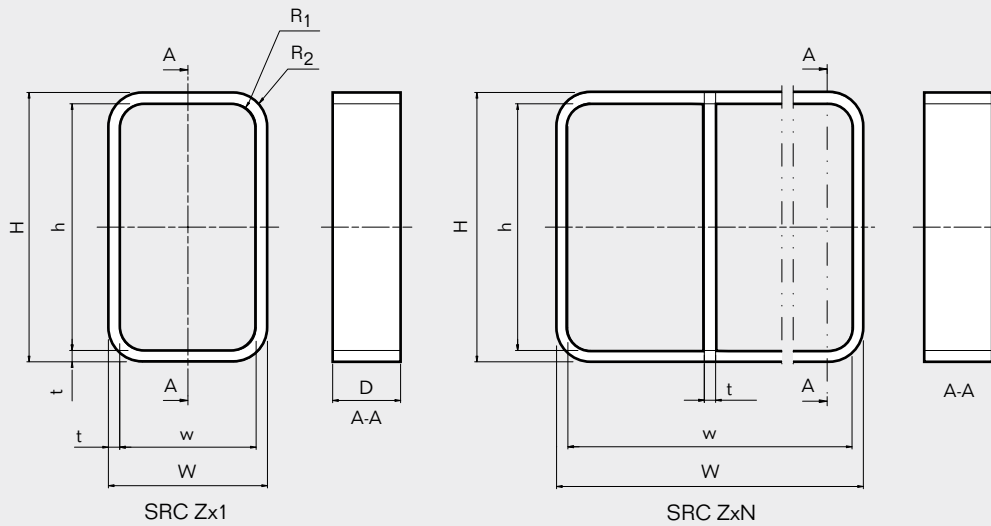

Pos	(mm)	(in)
h	H - 20	H - 0.787
w	W - 20	W - 0.787
D	60	2.362
t	10	0.394
R ₁	R 20 (4x)	R 0.787 (4x)
R ₂	R 30 (4x)	R 1.181 (4x)

Z = Frame size
 N = Number of horizontal openings

Note: All dimensions are nominal values

Packing space

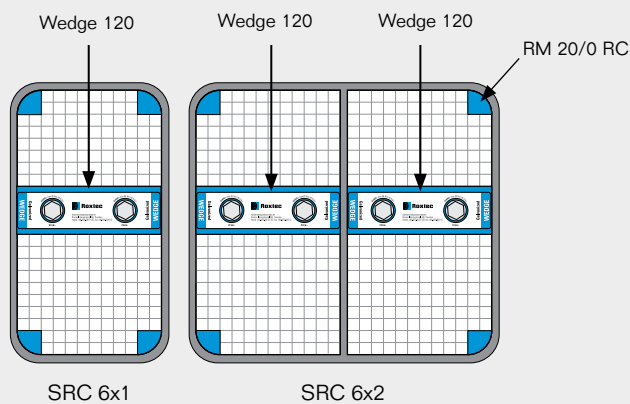

SRC frame, corner radius 40 mm, primed mild steel



SRC 6x1 r40 primed

See parts needed for a complete solution on page 26.

See installation instructions on page 226.

See practical user guidelines on page 264.

For information about other frame combinations, please contact your local Roxtec supplier or e-mail: info@roxtec.com

RATINGS Fire: A class, H class Water pressure: 4 bar Gas pressure: 2.5 bar

Frame	Frame openings	Packing space (mm)	External dimensions		Weight		Art. No
			HxW (mm)	HxW (in)	(kg)	(lb)	
SRC 4x1 r40 primed	1	120 x 120	180 x 141	7.077 x 5.551	2.8	6.151	SRC4000040112
SRC 4x2 r40 primed	2	120 x 120	180 x 271	7.077 x 10.669	4.7	10.318	SRC4000040212
SRC 4x3 r40 primed	3	120 x 120	180 x 402	7.077 x 15.827	6.6	14.484	SRC4000040312
SRC 4x4 r40 primed	4	120 x 120	180 x 532	7.077 x 20.945	8.5	18.629	SRC4000040412
SRC 4x5 r40 primed	5	120 x 120	180 x 663	7.077 x 26.102	10.3	22.796	SRC4000040512
SRC 4x6 r40 primed	6	120 x 120	180 x 793	7.077 x 31.220	12.2	26.962	SRC4000040612
SRC 4x7 r40 primed	7	120 x 120	180 x 924	7.077 x 36.378	14.1	31.129	SRC4000040712
SRC 4x8 r40 primed	8	120 x 120	180 x 1054	7.077 x 41.496	16.0	35.296	SRC4000040812
SRC 4x9 r40 primed	9	120 x 120	180 x 1185	7.077 x 46.654	17.9	39.440	SRC4000040912
SRC 6x1 r40 primed	1	180 x 120	238 x 141	9.370 x 5.551	3.3	7.363	SRC6000040112
SRC 6x2 r40 primed	2	180 x 120	238 x 271	9.370 x 10.669	5.5	12.147	SRC6000040212
SRC 6x3 r40 primed	3	180 x 120	238 x 402	9.370 x 15.827	7.7	16.909	SRC6000040312
SRC 6x4 r40 primed	4	180 x 120	238 x 532	9.370 x 20.945	9.8	21.671	SRC6000040412
SRC 6x5 r40 primed	5	180 x 120	238 x 663	9.370 x 26.102	12.0	26.455	SRC6000040512
SRC 6x6 r40 primed	6	180 x 120	238 x 793	9.370 x 31.220	14.2	31.217	SRC6000040612
SRC 6x7 r40 primed	7	180 x 120	238 x 924	9.370 x 36.378	16.3	35.979	SRC6000040712
SRC 6x8 r40 primed	8	180 x 120	238 x 1054	9.370 x 41.496	18.5	40.763	SRC6000040812
SRC 6x9 r40 primed	9	180 x 120	238 x 1185	9.370 x 46.654	20.8	45.525	SRC6000040912
SRC 8x1 r40 primed	1	240 x 120	298 x 141	11.732 x 5.551	3.9	8.620	SRC8000040112
SRC 8x2 r40 primed	2	240 x 120	298 x 271	11.732 x 10.669	6.1	13.382	SRC8000040212
SRC 8x3 r40 primed	3	240 x 120	298 x 402	11.732 x 15.827	8.2	18.144	SRC8000040312
SRC 8x4 r40 primed	4	240 x 120	298 x 532	11.732 x 20.945	10.4	22.928	SRC8000040412
SRC 8x5 r40 primed	5	240 x 120	298 x 663	11.732 x 26.102	12.6	27.690	SRC8000040512
SRC 8x6 r40 primed	6	240 x 120	298 x 793	11.732 x 31.220	14.7	32.452	SRC8000040612

* Please note that the corner radius reduces actual packing space for SRC frames.

SRC frame, corner radius 40 mm, technical information

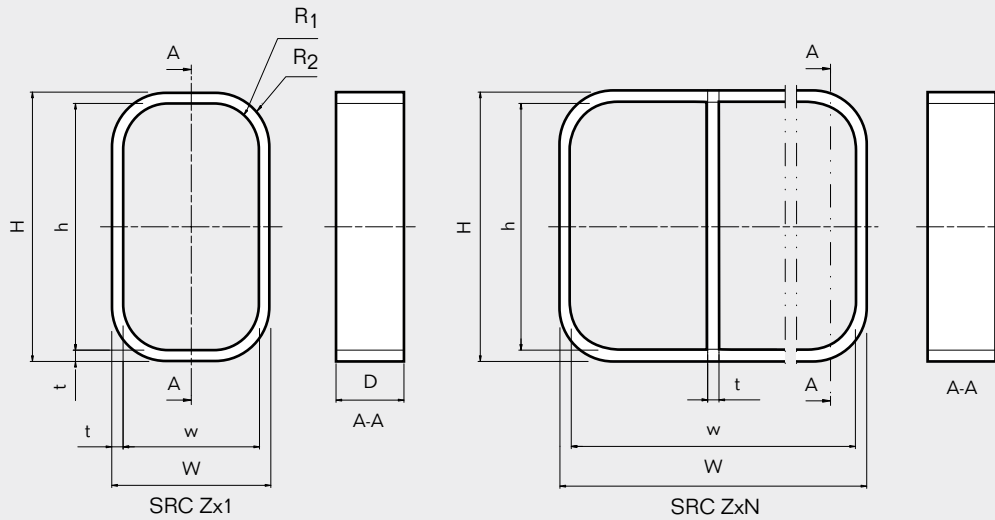

Pos	(mm)	(in)
h	H - 20	H - 0.787
w	W - 20	W - 0.787
D	60	2.362
t	10	0.394
R ₁	R 40 (4x)	R 1.575 (4x)
R ₂	R 50 (4x)	R 1.969 (4x)

Z = Frame size
N = Number of horizontal openings

Note: All dimensions are nominal values

Packing space

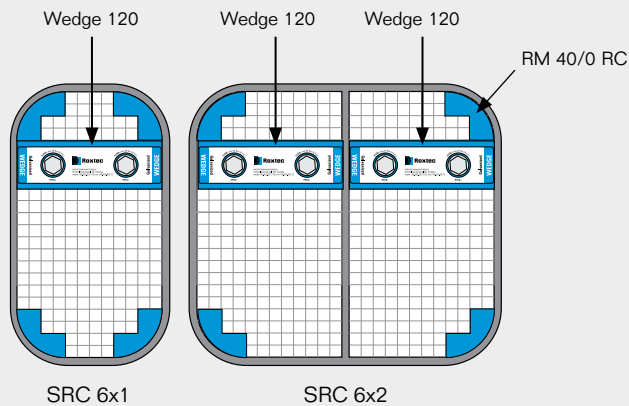



Roxtec SK frame

Roxtec SK frame is an S frame with extended depth. This enables, among other benefits, angled installations and/or increased distance between the packing space and the steel section.

- For use with Group RM components
- Attachment by welding

SK frame, primed mild steel



SK 6x1 primed

See parts needed for a complete solution on page 26.

See installation instructions on page 222.

See practical user guidelines on page 264.

Remove primer from the inside of the frame to ensure good conductivity in EMC applications.

For information about other frame combinations, please contact your local Roxtec supplier or e-mail: info@roxtec.com

RATINGS

Fire: A class, H class

Water pressure: 4 bar

Gas pressure: 2.5 bar

Frame	Frame openings	Packing space (mm)	External dimensions (D=100 mm)		Weight		Art. No
			HxW (mm)	HxW (in)	(kg)	(lb)	
SK 2x1 primed	1	60 x 120	121 x 141	4.764 x 5.551	4.4	9.612	5SK0000002074
SK 2x2 primed	2	60 x 120	121 x 271	4.764 x 10.669	7.1	15.675	5SK0000003137
SK 2x3 primed	3	60 x 120	121 x 402	4.764 x 15.827	9.9	21.738	5SK0000003138
SK 2x4 primed	4	60 x 120	121 x 532	4.764 x 20.945	12.6	27.800	5SK0000003148
SK 4x1 primed	1	120 x 120	180 x 141	7.087 x 5.551	5.4	11.905	5SK0000004398
SK 4x2 primed	2	120 x 120	180 x 271	7.087 x 10.669	8.4	18.585	5SK0000003139
SK 4x3 primed	3	120 x 120	180 x 402	7.087 x 15.827	11.5	25.243	5SK0000003140
SK 4x4 primed	4	120 x 120	180 x 532	7.087 x 20.945	14.5	31.923	5SK0000003141

SK frame, primed mild steel

Frame	Frame openings	Packing space (mm)	External dimensions (D=100 mm)		Weight		Art. No
			HxW (mm)	HxW (in)	(kg)	(lb)	
SK 6x1 primed	1	180 x 120	238 x 141	9.370 x 5.551	5.2	11.464	5SK0000004397
SK 6x2 primed	2	180 x 120	238 x 271	9.370 x 10.669	8.2	18.298	5SK0000004504
SK 6x3 primed	3	180 x 120	238 x 402	9.370 x 15.827	11	24.251	5SK0000004399
SK 6x4 primed	4	180 x 120	238 x 532	9.370 x 20.945	14.3	31.526	5SK0000004400
SK 8x1 primed	1	240 x 120	298 x 141	11.732 x 5.551	7.5	16.535	5SK0000004915
SK 8x2 primed	2	240 x 120	298 x 271	11.732 x 10.669	12.4	27.315	5SK0000003145
SK 8x3 primed	3	240 x 120	298 x 402	11.732 x 15.827	17.3	38.118	5SK0000003146
SK 8x4 primed	4	240 x 120	298 x 532	11.732 x 20.945	22.2	48.899	5SK0000003147

SK frame, technical information

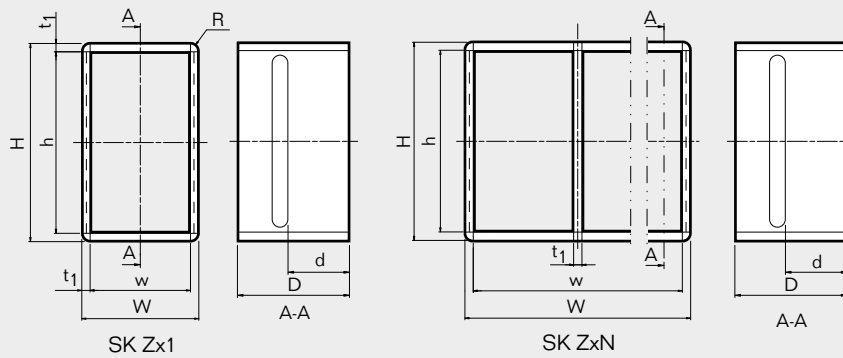

Pos	(mm)	(in)
h	H - 20	H - 0.787
w	W - 20	W - 0.787
D	100	3.937
d	60	2.362
t ₁	10	0.394
R	R 10	R 0.394

Z = Frame size
N = Number of horizontal openings

Note: All dimensions are nominal values

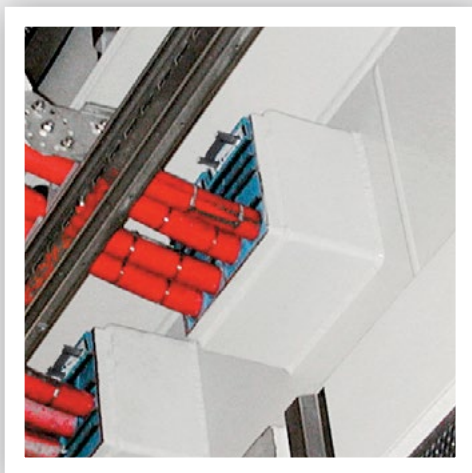

Roxtec SBTB frame

The Roxtec SBTB frame is a metal frame with two packing spaces behind each other (back-to-back). The SBTB frame is designed to meet high levels of fire protection and for easy verification of pressure tightness after installation.

- For use with two sets of Group RM components
- Pressure test pipe available
- Attachment by welding

SBTB frame, primed mild steel



SBTB 6x1 primed

See parts needed for a complete solution on page 26.

See installation instructions on page 222.

See practical user guidelines on page 264.

Remove primer from the inside of the frame to ensure good conductivity in EMC applications.

For information about other frame combinations, please contact your local Roxtec supplier or e-mail: info@roxtec.com

RATINGS

Fire: A class, H class

Water pressure: 4 bar

Gas pressure: 2.5 bar

Frame	Frame openings	Packing space (mm)	External dimensions (D=200 mm)		Weight		Art. No
			HxW (mm)	HxW (in)	(kg)	(lb)	
SBTB 2x1 primed	1	60 x 120	121 x 141	4.764 x 5.531	7.2	15.939	5SBT000003961
SBTB 2x2 primed	2	60 x 120	121 x 271	4.764 x 10.669	12.0	26.389	SBTB020000212
SBTB 2x3 primed	3	60 x 120	121 x 402	4.764 x 15.827	16.7	36.839	SBTB020000312
SBTB 2x4 primed	4	60 x 120	121 x 532	4.764 x 20.945	21.5	47.289	SBTB020000412
SBTB 4x1 primed	1	120 x 120	180 x 141	7.087 x 5.531	8.9	19.709	5S00000004392
SBTB 4x2 primed	2	120 x 120	180 x 271	7.087 x 10.669	14.2	31.372	SBTB040000212
SBTB 4x3 primed	3	120 x 120	180 x 402	7.087 x 15.807	19.5	43.034	SBTB040000312
SBTB 4x4 primed	4	120 x 120	180 x 532	7.087 x 20.945	24.8	54.697	SBTB040000412
SBTB 4x5 primed	5	120 x 120	180 x 663	7.087 x 26.083	30.1	66.359	SBTB040000512
SBTB 4x6 primed	6	120 x 120	180 x 793	7.087 x 31.220	35.4	78.022	SBTB040000612

SBTB frame, primed mild steel

Frame	Frame openings	Packing space (mm)	External dimensions (D=200 mm)		Weight		Art. No
			HxW (mm)	HxW (in)	(kg)	(lb)	
SBTB 6x1 primed	1	180 x 120	238 x 141	9.370 x 5.531	10.6	23.479	5S00000004391
SBTB 6x2 primed	2	180 x 120	238 x 271	9.370 x 10.669	16.5	36.354	5S00000004503
SBTB 6x3 primed	3	180 x 120	238 x 402	9.370 x 15.807	22.3	49.229	5S00000004393
SBTB 6x4 primed	4	180 x 120	238 x 532	9.370 x 20.945	28.2	62.104	5S00000004394
SBTB 6x5 primed	5	180 x 120	238 x 663	9.370 x 26.083	34.0	74.979	5S00000004528
SBTB 6x6 primed	6	180 x 120	238 x 793	9.370 x 31.220	39.9	87.854	5S00000004500
SBTB 8x1 primed	1	240 x 120	298 x 141	11.732 x 5.531	12.4	27.337	SBTB080000112
SBTB 8x2 primed	2	240 x 120	298 x 271	11.732 x 10.669	18.8	41.469	SBTB080000212
SBTB 8x3 primed	3	240 x 120	298 x 402	11.732 x 15.807	25.2	55.579	SBTB080000312
SBTB 8x4 primed	4	240 x 120	298 x 532	11.732 x 20.945	31.6	69.710	SBTB080000412

SBTB frame, technical information

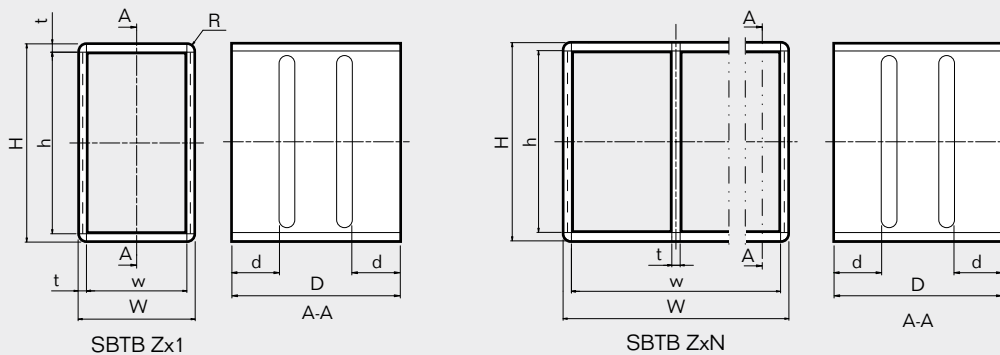

Pos	(mm)	(in)
h	H - 20	H - 0.787
w	W - 20	W - 0.787
D	200	7.874
d	60	2.362
t	10	0.394
R	R 10	R 0.394

Z = Frame size
N = Number of horizontal openings

Note: All dimensions are nominal values

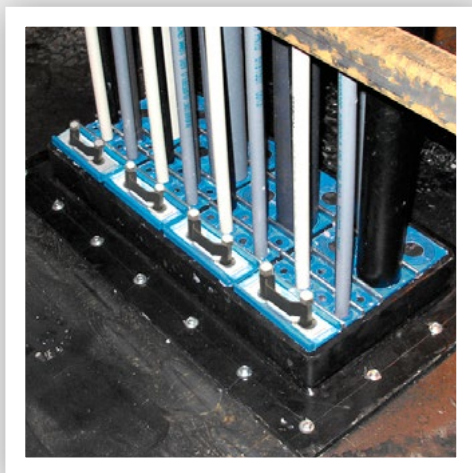

Roxtec SF frame

Roxtec SF frame is a metal frame with flange. Available with a single opening, or in combinations with several openings in width and/or height.

- For use with Group RM components
- Attachment by welding or bolting

SF frame, primed mild steel



SF 6x1 primed

See parts needed for a complete solution on page 26.

See installation instructions on page 222.

See practical user guidelines on page 264.

Remove primer from the inside of the frame to ensure good conductivity in EMC applications.

For information about other frame combinations, or for openable versions of this frame, please contact your local Roxtec supplier or e-mail: info@roxtec.com

RATINGS

Fire: A class, H class

Water pressure: 4 bar

Gas pressure: 2.5 bar

Frame	Frame openings	Packing space (mm)	External dimensions (D=60 mm)		Weight		Art. No
			HxW (mm)	HxW (in)	(kg)	(lb)	
SF 2x1 primed	1	60 x 120	241 x 261	9.488 x 10.276	6.0	13.184	SFF2000000112
SF 2x2 primed	2	60 x 120	241 x 391	9.488 x 15.394	9.0	19.775	SFF2000000212
SF 2x3 primed	3	60 x 120	241 x 522	9.488 x 20.551	12.0	26.345	SFF2000000312
SF 2x4 primed	4	60 x 120	241 x 652	9.488 x 25.669	14.9	32.937	SFF2000000412
SF 2x5 primed	5	60 x 120	241 x 783	9.488 x 30.827	17.9	39.528	SFF2000000512
SF 2x6 primed	6	60 x 120	241 x 913	9.488 x 35.945	20.9	46.098	SFF2000000612
SF 4x1 primed	1	120 x 120	300 x 261	11.811 x 10.276	7.1	15.675	SFF4000000112
SF 4x2 primed	2	120 x 120	300 x 391	11.811 x 15.394	10.4	22.862	SFF4000000212
SF 4x3 primed	3	120 x 120	300 x 522	11.811 x 20.551	13.6	30.049	SFF4000000312
SF 4x4 primed	4	120 x 120	300 x 652	11.811 x 25.669	16.9	37.236	SFF4000000412

SF frame, primed mild steel

Frame	Frame openings	Packing space (mm)	External dimensions (D=60 mm)		Weight		Art. No
			HxW (mm)	HxW (in)	(kg)	(lb)	
SF 4x5 primed	5	120 x 120	300 x 783	11.811 x 30.827	20.2	44.423	SFF4000000512
SF 4x6 primed	6	120 x 120	300 x 913	11.811 x 35.945	23.4	51.632	SFF4000000612
SF 4+4x1 primed	2	120 x 120	469 x 261	18.465 x 10.276	10.9	24.118	SFF4400000112
SF 4+4+4x1 primed	3	120 x 120	639 x 261	25.157 x 10.276	14.8	32.540	SFF4440000112
SF 6x1 primed	1	180 x 120	358 x 261	14.095 x 10.276	8.2	18.144	SFF6000000112
SF 6x2 primed	2	180 x 120	358 x 391	14.095 x 15.394	11.8	25.948	SFF6000000212
SF 6x3 primed	3	180 x 120	358 x 522	14.095 x 20.551	15.3	33.752	SFF6000000312
SF 6x4 primed	4	180 x 120	358 x 652	14.095 x 25.669	18.8	41.557	SFF6000000412
SF 6x5 primed	5	180 x 120	358 x 783	14.095 x 30.827	22.4	49.339	SFF6000000512
SF 6x6 primed	6	180 x 120	358 x 913	14.095 x 35.945	25.9	57.143	SFF6000000612
SF 6+6x1 primed	2	180 x 120	586 x 261	23.071 x 10.276	13.1	28.968	SFF6600000112
SF 6+6x2 primed	4	180 x 120	596 x 391	23.465 x 15.394	19.6	43.320	SFF6600000212
SF 6+6x3 primed	6	180 x 120	596 x 522	23.465 x 20.551	25.4	56.107	SFF6600000312
SF 6+6x4 primed	8	180 x 120	596 x 652	23.465 x 25.669	31.2	68.872	SFF6600000412
SF 6+6x5 primed	10	180 x 120	596 x 783	23.465 x 30.827	37.0	81.636	SFF6600000512
SF 6+6x6 primed	12	180 x 120	596 x 913	23.465 x 35.945	42.8	94.423	SFF6600000612
SF 6+6x7 primed	14	180 x 120	596 x 1044	23.465 x 41.102	48.6	107.188	SFF6600000712
SF 6+6x8 primed	16	180 x 120	596 x 1174	23.465 x 46.220	54.4	119.974	SFF6600000812
SF 6+6x9 primed	18	180 x 120	596 x 1305	23.465 x 51.378	60.2	132.739	SFF6600000912
SF 6+6x10 primed	20	180 x 120	596 x 1435	23.465 x 56.496	66.0	145.504	SFF6600001012
SF 6+6+6x1 primed	3	180 x 120	814 x 261	32.047 x 10.276	18.1	39.991	SFF6660000112
SF 8x1 primed	1	240 x 120	418 x 261	16.457 x 10.276	9.4	20.701	SFF8000000112
SF 8x2 primed	2	240 x 120	418 x 391	16.457 x 15.394	13.2	29.123	SFF8000000212
SF 8x3 primed	3	240 x 120	418 x 522	16.457 x 20.551	17.0	37.544	SFF8000000312
SF 8x4 primed	4	240 x 120	418 x 652	16.457 x 25.669	20.8	45.966	SFF8000000412
SF 8x5 primed	5	240 x 120	418 x 783	16.457 x 30.827	24.7	54.387	SFF8000000512
SF 8x6 primed	6	240 x 120	418 x 913	16.457 x 35.945	28.5	62.809	SFF8000000612
SF 8+8x1 primed	2	240 x 120	706 x 261	27.795 x 10.276	15.5	34.171	SFF8800000112
SF 8+8x2 primed	4	240 x 120	716 x 391	28.189 x 15.394	22.6	49.758	SFF8800000212
SF 8+8x3 primed	6	240 x 120	716 x 522	28.189 x 20.551	28.9	63.779	SFF8800000312
SF 8+8x4 primed	8	240 x 120	716 x 652	28.189 x 25.669	35.3	77.800	SFF8800000412
SF 8+8x5 primed	10	240 x 120	716 x 783	28.189 x 30.827	41.6	91.822	SFF8800000512
SF 8+8x6 primed	12	240 x 120	716 x 913	28.189 x 35.945	48.0	105.843	SFF8800000612
SF 8+8x7 primed	14	240 x 120	716 x 1044	28.189 x 41.102	54.4	119.864	SFF8800000712
SF 8+8x8 primed	16	240 x 120	716 x 1174	28.189 x 46.220	60.7	133.885	SFF8800000812
SF 8+8x9 primed	18	240 x 120	716 x 1305	28.189 x 51.378	67.1	147.907	SFF8800000912
SF 8+8x10 primed	20	240 x 120	716 x 1435	28.189 x 56.496	73.4	161.928	SFF8800001012
SF 8+8+8x1 primed	3	240 x 120	944 x 261	37.165 x 10.276	21.6	47.619	SFF8880000112

SF frame, acid-proof stainless steel



SF 6x1 AISI 316

See parts needed for a complete solution on page 26.

See installation instructions on page 222.

See practical user guidelines on page 264.

For information about other frame combinations, or for openable versions of this frame, please contact your local Roxtec supplier or e-mail: info@roxtec.com

RATINGS							
Fire: A class, H class		Water pressure: 4 bar		Gas pressure: 2.5 bar			
Frame	Frame openings	Packing space (mm)	External dimensions (D=60 mm)		Weight		Art. No
			HxW (mm)	HxW (in)	(kg)	(lb)	
SF 2x1 AISI 316	1	60 x 120	241 x 261	9.488 x 10.276	6.0	13.184	SFF2000000121
SF 4x1 AISI 316	1	120 x 120	300 x 261	11.811 x 10.276	7.1	15.675	SFF4000000121
SF 4x2 AISI 316	2	120 x 120	300 x 391	11.811 x 15.394	10.4	22.862	SFF4000000221
SF 4x3 AISI 316	3	120 x 120	300 x 522	11.811 x 20.551	13.6	30.049	SFF4000000321
SF 4x4 AISI 316	4	120 x 120	300 x 652	11.811 x 25.669	16.9	37.236	SFF4000000421
SF 6x1 AISI 316	1	180 x 120	358 x 261	14.095 x 10.276	8.2	18.144	SFF6000000121
SF 6x2 AISI 316	2	180 x 120	358 x 391	14.095 x 15.394	11.8	25.948	SFF6000000221
SF 6x3 AISI 316	3	180 x 120	358 x 522	14.095 x 20.551	15.3	33.752	SFF6000000321
SF 6x4 AISI 316	4	180 x 120	358 x 652	14.095 x 25.669	18.8	41.557	SFF6000000421
SF 8x1 AISI 316	1	240 x 120	418 x 261	16.457 x 10.276	9.4	20.701	SFF8000000121
SF 8x2 AISI 316	2	240 x 120	418 x 391	16.457 x 15.394	13.2	29.123	SFF8000000221
SF 8x3 AISI 316	3	240 x 120	418 x 522	16.457 x 20.551	17.0	37.544	SFF8000000321
SF 8x4 AISI 316	4	240 x 120	418 x 652	16.457 x 25.669	20.8	45.966	SFF8000000421

SF frame, aluminum



SF 6x1 ALU

See parts needed for a complete solution on page 26.

See installation instructions on page 222.

See practical user guidelines on page 264.

For information about other frame combinations, or for openable versions of this frame, please contact your local Roxtec supplier or e-mail: info@roxtec.com

RATINGS
Fire: A class, H class

Water pressure: 4 bar

Gas pressure: 2.5 bar

Frame	Frame openings	Packing space (mm)	External dimensions (D=60 mm)		Weight		Art. No
			HxW (mm)	HxW (in)	(kg)	(lb)	
SF 2x1 ALU	1	60 x 120	241 x 261	9.488 x 10.276	2.1	4.541	SFF2000000131
SF 4x1 ALU	1	120 x 120	300 x 261	11.811 x 10.276	2.4	5.379	SFF4000000131
SF 4x2 ALU	2	120 x 120	300 x 391	11.811 x 15.394	3.6	7.870	SFF4000000231
SF 4x3 ALU	3	120 x 120	300 x 522	11.811 x 20.551	4.7	10.340	SFF4000000331
SF 4x4 ALU	4	120 x 120	300 x 652	11.811 x 25.669	5.8	12.809	SFF4000000431
SF 6x1 ALU	1	180 x 120	358 x 261	14.095 x 10.276	3.3	7.187	SFF6000000131
SF 6x2 ALU	2	180 x 120	358 x 391	14.095 x 15.394	4.6	10.229	SFF6000000231
SF 6x3 ALU	3	180 x 120	358 x 522	14.095 x 20.551	6.0	13.250	SFF6000000331
SF 6x4 ALU	4	180 x 120	358 x 652	14.095 x 25.669	7.4	16.292	SFF6000000431
SF 8x1 ALU	1	240 x 120	418 x 261	16.457 x 10.276	3.7	8.157	SFF8000000131
SF 8x2 ALU	2	240 x 120	418 x 391	16.457 x 15.394	5.2	11.398	SFF8000000231
SF 8x3 ALU	3	240 x 120	418 x 522	16.457 x 20.551	6.6	14.661	SFF8000000331
SF 8x4 ALU	4	240 x 120	418 x 652	16.457 x 25.669	8.1	17.901	SFF8000000431

SF frame, technical information

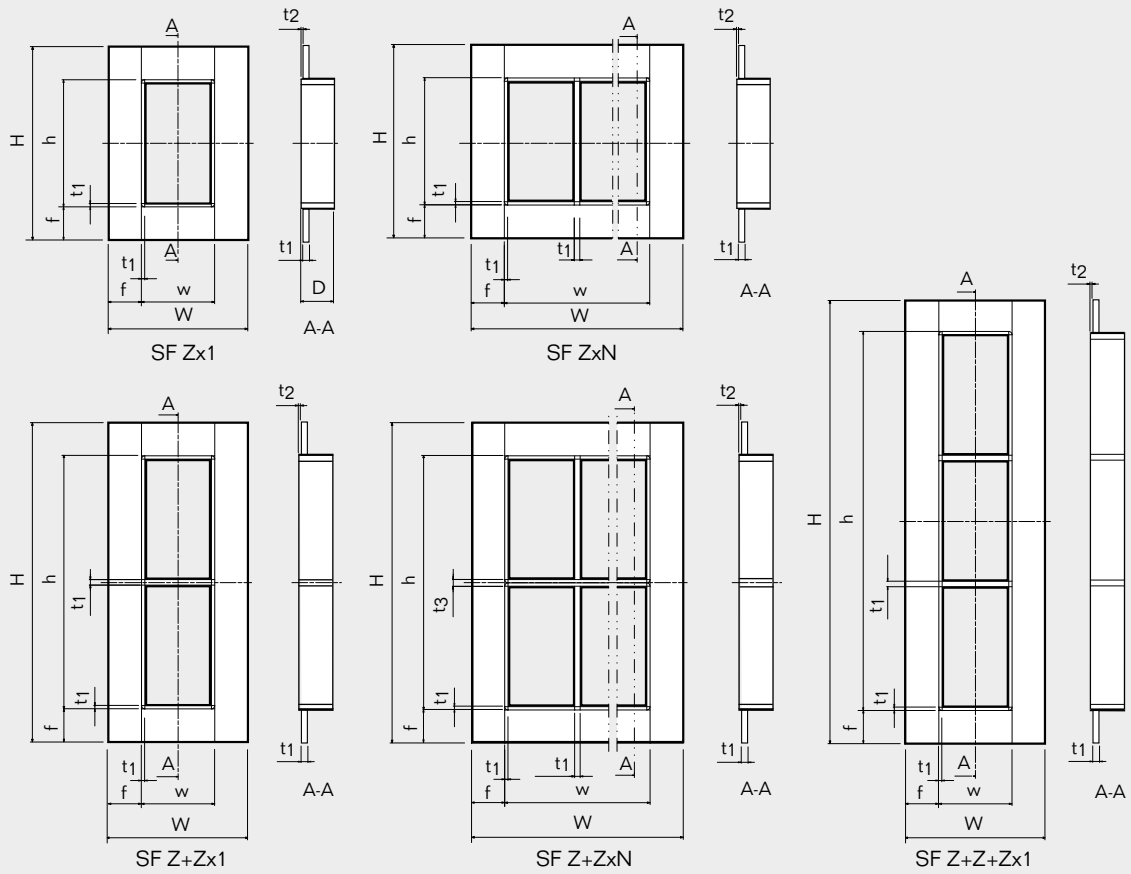

Pos	(mm)	(in)
h	H - 120	H - 4.724
w	W - 120	W - 4.724
D	60	2.362
f	60	2.362
t1	10	0.394
t2	3	0.118
t3	20	0.787

Z = Frame size
 N = Number of horizontal openings

Note: All dimensions are nominal values



Roxtec GHM frame

The Roxtec GHM frame is designed for installation through bolting where welding is not suitable. The frame is sealed onto the structure by use of the TSL sealing strip.

- For use with Group RM components
- Attachment by bolting
- Drilled according to standardized hole pattern

GHM frame, primed mild steel



GHM 6x1 primed

See parts needed for a complete solution on page 26.

See installation instructions on page 222.

See practical user guidelines on page 264.

Remove primer from the inside of the frame to ensure good conductivity in EMC applications.

For information about other frame combinations, please contact your local Roxtec supplier or e-mail: info@roxtec.com

RATINGS

Fire: A class

Water pressure: 3 bar

Gas pressure: 1.5 bar

Frame	Frame openings	Packing space (mm)	External dimensions (D=60 mm)		Weight		Art. No
			HxW (mm)	HxW (in)	(kg)	(lb)	
GHM 2x1 primed	1	60 x 120	233 x 253	9.173 x 9.961	3.4	7.562	GHM2000000112
GHM 2x2 primed	2	60 x 120	233 x 383	9.173 x 15.079	5.4	11.905	GHM2000000212
GHM 2x3 primed	3	60 x 120	233 x 514	9.173 x 20.236	7.4	16.218	GHM2000000312
GHM 4x1 primed	1	120 x 120	292 x 253	11.496 x 9.961	4.1	9.039	GHM4000000112
GHM 4x2 primed	2	120 x 120	292 x 383	11.496 x 15.079	6.3	13.977	GHM4000000212
GHM 4x3 primed	3	120 x 120	292 x 514	11.496 x 20.236	8.6	18.938	GHM4000000312
GHM 6x1 primed	1	180 x 120	350 x 253	13.780 x 13.961	4.8	10.516	GHM6000000112
GHM 6x2 primed	2	180 x 120	350 x 383	13.780 x 15.079	7.3	16.072	GHM6000000212
GHM 6x3 primed	3	180 x 120	350 x 514	13.780 x 20.236	9.8	21.627	GHM6000000312

GHM frame, technical information

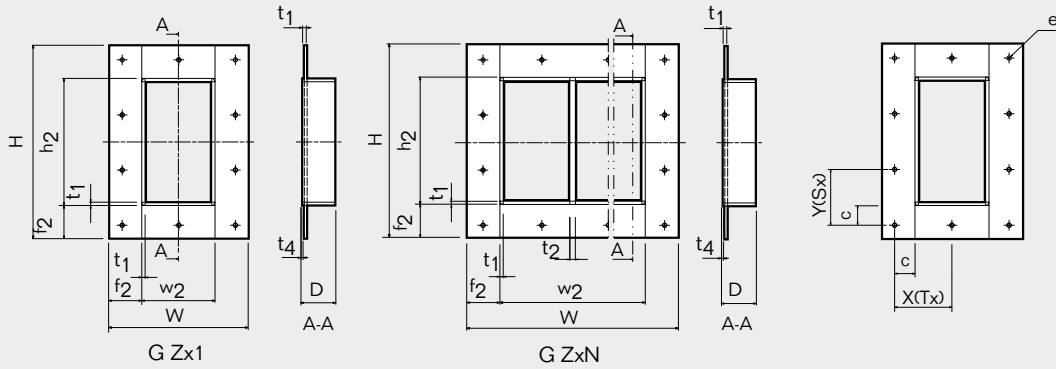

Z = Frame size
 N = Number of horizontal openings

Hole pattern

Pos	(mm)	(in)
h ₂	H - 120	H - 4.724
w ₂	W - 120	W - 4.724
D	60	2.362
f ₂	60	2.362
t ₁	6	0.263
t ₂	10	0.394
t ₃	12	0.394
t ₄	3	0.118
e	10	0.394
c	35	1.378

	X(Tx)			Y(Sx)		
	X (mm)	X (in)	T	Y (mm)	Y (in)	S
GHM 2x1	101.3	3.988	2	91.5	3.602	2
GHM 2x2	111	4.370	3	91.5	3.602	2
GHM 2x3	92.7	3.650	5	91.5	3.602	2
GHM 4x1	101.3	3.988	2	80.5	3.169	3
GHM 4x2	111	4.370	3	80.5	3.169	3
GHM 4x3	92.7	3.650	5	80.5	3.169	3
GHM 6x1	101.3	3.988	2	75	2.953	4
GHM 6x2	111	4.370	3	75	2.953	4
GHM 6x3	92.7	3.650	5	75	2.953	4

Note: All dimensions are nominal values

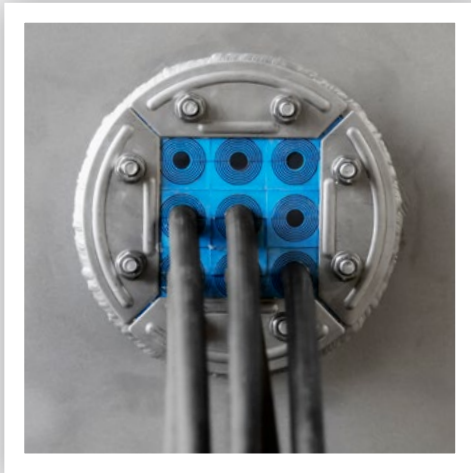

Roxtec R frame

The Roxtec R is a round expansion frame with a square packing space for cables and modules. Compression is integrated in the frame. Allows installation around existing cables.

- For use with RM modules
- Attachment by expansion in sleeves
- Sleeves are available

R frame, galvanized fittings



R 100 galv



R 125 galv



R 127 galv



R 150 galv



R 200 galv

See parts needed for a complete solution on page 26.

See sleeves on page 66.

See installation instructions on page 231.

RATINGS Fire: A class, H class Water pressure: 4 bar Gas pressure: 2.5 bar

Frame	Packing space (mm)	For hole Ø		Weight		Art. No
		(mm)	(in)	(kg)	(lb)	
R 100 galv	60 x 60	100-102	3.937-4.016	0.7	1.499	R000001001018
R 125 galv	80 x 80	125-127	4.921-5.000	1.1	2.447	R000001251018
R 127 galv	80 x 80	127-129	5.000-5.079	1.1	2.447	R000001271018
R 150 galv	90 x 90	150-152	5.906-5.984	1.6	3.638	R000001501018
R 200 galv	120 x 120	200-202	7.874-7.953	2.6	5.732	R000002001018

R frame, acid-proof stainless steel fittings



R 70 AISI 316



R 75 AISI 316



R 100 AISI 316



R 125 AISI 316



R 127 AISI 316



R 150 AISI 316

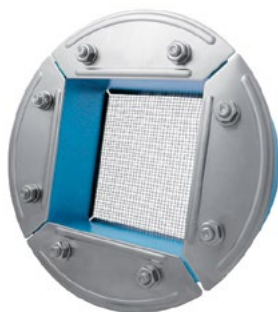

R 200 AISI 316

See parts needed for a complete solution on page 26.
See sleeves on page 66.
See installation instructions on page 231.

RATINGS

Fire: A class, H class

Water pressure: 4 bar

Gas pressure: 2.5 bar

Frame	Packing space (mm)	For hole Ø		Weight		Art. No
		(mm)	(in)	(kg)	(lb)	
R 70 AISI 316	40 x 40	70-72	2.756-2.835	0.5	1.014	R000000701021
R 75 AISI 316	40 x 40	75-77	2.953-3.031	0.5	1.102	R000000751021
R 100 AISI 316	60 x 60	100-102	3.937-4.016	0.6	1.499	R000001001021
R 125 AISI 316	80 x 80	125-127	4.921-5.000	1.1	2.447	R000001251021
R 127 AISI 316	80 x 80	127-129	5.000-5.079	1.1	2.447	R000001271021
R 150 AISI 316	90 x 90	150-152	5.906-5.984	1.6	3.638	R000001501021
R 200 AISI 316	120 x 120	200-202	7.874-7.953	2.6	5.732	R000002001021

R frame, technical information

R 70 / R 75

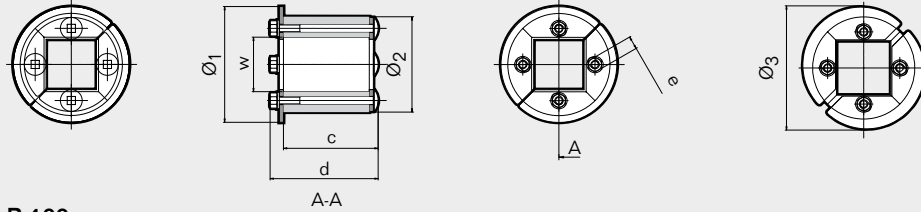

R 100

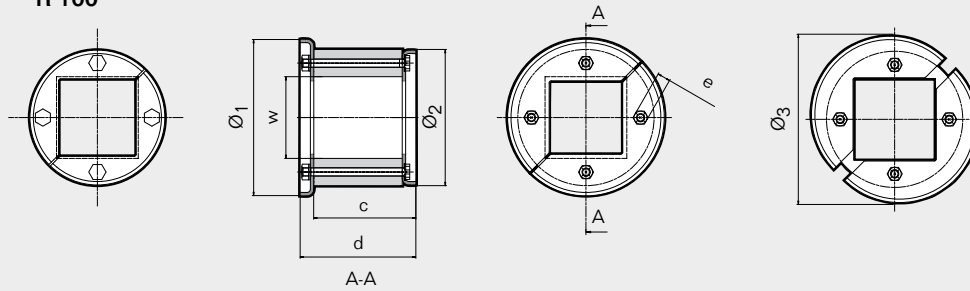

R 125 / R 127 / R 150 / R 200

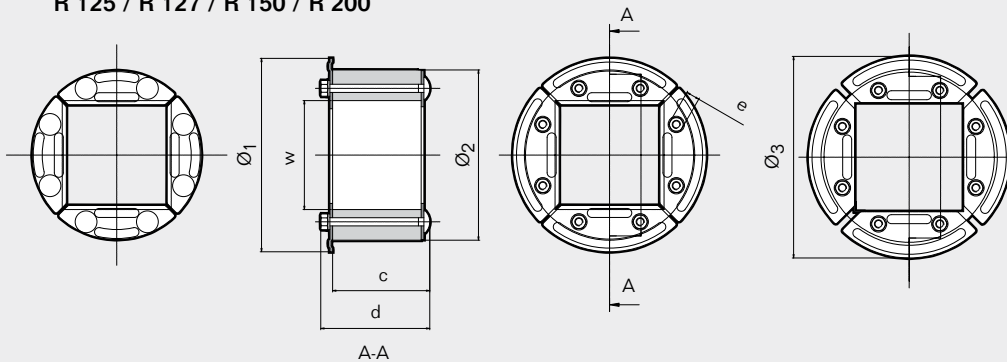

	R 70		R 75		R 100		R 125		R 127		R 150		R 200	
Pos	(mm)	(in)	(mm)	(in)	(mm)	(in)	(mm)	(in)	(mm)	(in)	(mm)	(in)	(mm)	(in)
Ø ₁	85	3.346	85	3.346	115	4.528	142	5.591	142	5.591	165	6.496	215	8.465
Ø ₂	70	2.756	75	2.953	100	3.937	125	4.921	127	5.000	150	5.906	200	7.874
Ø ₃	91	3.583	91	3.583	125	4.921	148	5.827	148	5.827	171	6.732	223	8.780
w (□)	40	1.575	40	1.575	60	2.362	80	3.150	80	3.150	90	3.543	120	4.724
c	71	2.795	71	2.795	75	2.953	71	2.795	71	2.795	71	2.795	71	2.795
d	85	3.346	85	3.346	85	3.346	80	3.150	80	3.150	85	3.346	85	3.346
e	*	*	*	*	*	*	**	**	**	**	***	***	***	***

* SW10 mm (4x) / SW0.394" (4x) ** SW10 mm (8x) / SW0.394 (8x) *** SW13 mm (8x) / SW0.512 (8x)

Ø₃ = Dimension with front fittings in outer position

Note: All dimensions are nominal values

Sleeves without flange, for R frame



SLR primed mild steel



SLR acid-proof stainless steel



SLR aluminum

See practical user guidelines on page 264.

Primed mild steel

Sleeve	External dimensions				Internal Ø		Weight		Art. No
	Ø (mm)	Ø (in)	L (mm)	L (in)	(mm)	(in)	(kg)	(lb)	
SLR 70 primed	83	3.262	55	2.165	71.5	2.815	0.58	1.27	ASLR100700012
SLR 75 primed	89	3.498	55	2.165	76.5	3.012	0.72	1.58	ASLR100750012
SLR 100 primed	114	4.480	55	2.165	101	3.976	0.93	2.05	ASLR101000012
SLR 125 primed	140	5.502	55	2.165	126	4.961	1.17	2.59	ASLR101250012
SLR 127 primed	140	5.502	55	2.165	128	5.039	1.01	2.23	ASLR101270012
SLR 150 primed	164	6.445	55	2.165	151	5.945	1.38	3.04	ASLR101500012
SLR 200 primed	214	8.410	55	2.165	201	7.913	1.80	3.97	ASLR102000012

Acid-proof stainless steel

Sleeve	External dimensions				Internal Ø		Weight		Art. No
	Ø (mm)	Ø (in)	L (mm)	L (in)	(mm)	(in)	(kg)	(lb)	
SLR 70 AISI 316	83	3.262	55	2.165	71.5	2.815	0.60	1.32	ASLR100700021
SLR 75 AISI 316	89	3.498	55	2.165	76.5	3.012	0.71	1.57	ASLR100750021
SLR 100 AISI316	114	4.480	55	2.165	101	3.976	0.96	2.12	ASLR101000021
SLR 125 AISI 316	140	5.502	55	2.165	126	4.961	1.21	2.66	ASLR101250021
SLR 127 AISI 316	140	5.502	55	2.165	128	5.039	1.09	2.41	ASLR101270021
SLR 150 AISI 316	164	6.445	55	2.165	151	5.945	1.39	3.07	ASLR101500021
SLR 200 AISI 316	214	8.410	55	2.165	201	7.913	1.85	4.07	ASLR102000021

Aluminum

Sleeve	External dimensions				Internal Ø		Weight		Art. No
	Ø (mm)	Ø (in)	L (mm)	L (in)	(mm)	(in)	(kg)	(lb)	
SLR 70 Alu	83	3.268	55	2.165	71.5	2.815	0.15	0.33	5ASLR00003974
SLR 75 Alu	89	3.504	55	2.165	76.5	3.012	0.22	0.49	5ASLR00008711
SLR 100 Alu	114	4.488	55	2.165	101	3.976	0.33	0.73	5ASLR00000894
SLR 125 Alu	140	5.512	55	2.165	126	4.961	0.40	0.88	5ASLR000007647
SLR 127 Alu	140	5.512	55	2.165	128	5.039	0.50	1.10	5ASLR00003246
SLR 150 Alu	164	6.457	55	2.165	151	5.945	0.45	0.99	5ASLR00003239
SLR 200 Alu	214	8.425	55	2.165	201	7.913	1.00	2.20	5ASLR00003240

Sleeves with flange, for R frame



SLFR primed mild steel



SLFR galvanized mild steel



SLFR aluminum

See practical user guidelines on page 264.

Primed mild steel

Sleeve	External flange Ø		External dimensions				Internal Ø		Weight		Art. No
	(mm)	(in)	Ø (mm)	Ø (in)	L (mm)	L (in)	(mm)	(in)	(kg)	(lb)	
SLFR 70 primed	160	6.299	160	6.299	55	2.165	71.5	2.815	1.05	2.31	ASFR100700012
SLFR 75 primed	165	6.496	165	6.496	55	2.165	76.5	3.012	1.20	2.63	ASFR100750012
SLFR 100 primed	195	7.677	195	7.677	55	2.165	101	3.976	1.58	3.48	ASFR101000012
SLFR 125 primed	213	8.386	213	8.386	55	2.165	126	4.961	1.82	4.00	ASFR101250012
SLFR 127 primed	213	8.386	213	8.386	55	2.165	128	5.039	1.67	3.68	ASFR101270012
SLFR 150 primed	236	9.291	236	9.291	55	2.165	151	5.945	2.10	4.63	ASFR101500012
SLFR 200 primed	290	11.417	290	11.417	55	2.165	201	7.913	2.78	6.13	ASFR102000012

Galvanized mild steel

Sleeve	External flange Ø		External dimensions				Internal Ø		Weight		Art. No
	(mm)	(in)	Ø (mm)	Ø (in)	L (mm)	L (in)	(mm)	(in)	(kg)	(lb)	
SLFR 70 galv	160	6.299	160	6.299	55	2.165	71.5	2.815	1.08	2.37	ASFR100700015
SLFR 75 galv	165	6.496	165	6.496	55	2.165	76.5	3.012	1.23	2.71	ASFR100750015
SLFR 100 galv	195	7.677	195	7.677	55	2.165	101	3.976	1.61	3.55	ASFR101000015
SLFR 125 galv	213	8.386	213	8.386	55	2.165	126	4.961	1.91	4.20	ASFR101250015
SLFR 127 galv	213	8.386	213	8.386	55	2.165	128	5.039	1.73	3.81	ASFR101270015
SLFR 150 galv	236	9.291	236	9.291	55	2.165	151	5.945	2.18	4.80	ASFR101500015
SLFR 200 galv	290	11.417	290	11.417	55	2.165	201	7.913	2.90	6.39	ASFR102000015

Aluminum

Sleeve	External flange Ø		External dimensions				Internal Ø		Weight		Art. No
	(mm)	(in)	Ø (mm)	Ø (in)	L (mm)	L (in)	(mm)	(in)	(kg)	(lb)	
SLFR 70 Alu	160	6.299	160	6.299	55	2.165	71.5	2.815	0.33	0.73	5ASFR00008713
SLFR 75 Alu	165	6.496	165	6.496	55	2.165	76.5	3.012	0.40	0.88	5ASFR00008712
SLFR 100 Alu	195	7.677	195	7.677	55	2.165	101	3.976	0.53	1.17	5ASFR00001917
SLFR 125 Alu	213	8.386	213	8.386	55	2.165	126	4.961	0.63	1.39	5ASFR00004286
SLFR 127 Alu	213	8.386	213	8.386	55	2.165	128	5.039	0.57	1.26	5ASFR00008714
SLFR 150 Alu	236	9.291	236	9.291	55	2.165	151	5.945	0.71	1.57	5ASFR00007671
SLFR 200 Alu	290	11.417	290	11.417	55	2.165	201	7.913	0.96	2.12	5ASFR00001918

Openable sleeves with flange, for R frame



SLFO/RI acid-proof stainless steel

See practical user guidelines on page 264.

Acid-proof stainless steel

Sleeve	External flange diameter		Aperture diameter		Weight		Art. No
	ØA (mm)	ØA (in)	ØB (mm)	ØB (in)	(kg)	(lb)	
SLFO/RI 75 AISI 316	252	9.9	188	7.4	5.5	12.1	SLFORI0007521
SLFO/RI 100 AISI 316	317	12.5	253	9.9	9.5	20.9	SLFORI0010021
SLFO/RI 125 AISI 316	343	13.5	279	10.9	10.8	23.8	SLFORI0012521
SLFO/RI 150 AISI 316	367	14.5	303	11.9	11.6	25.6	SLFORI0015021
SLFO/RI 200 AISI 316	417	16.4	353	13.9	13.7	3	SLFORI0020021

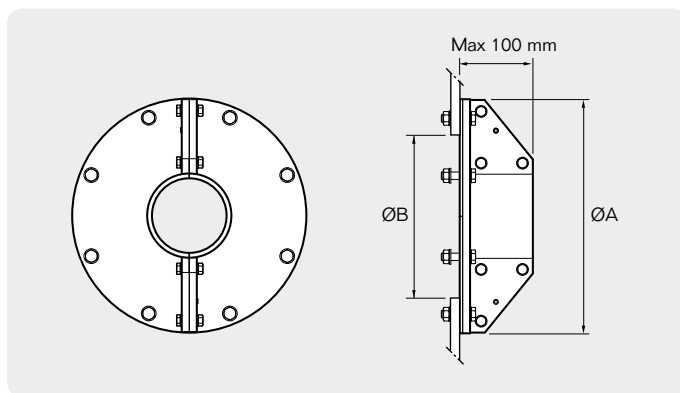

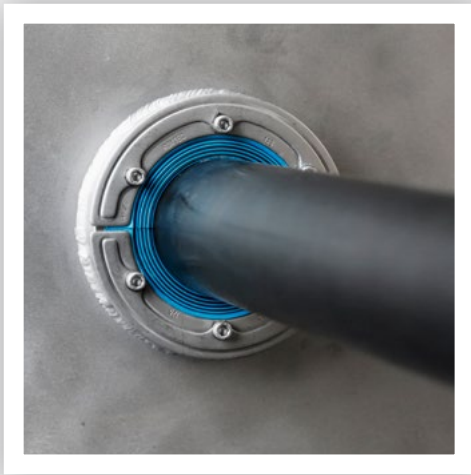

Roxtec RS seal

The Roxtec RS is a round entry seal, consisting of two halves and an adaptable center with removable layers. Compression is integrated in the seal. Allows installation around an existing cable.

- Attachment by expansion in holes
- For one cable
- Sleeves are available

RS seal, with core, acid-proof stainless steel fittings



See sleeves on page 73.
 See installation instructions on page 233.
 See practical user guidelines on page 264.

RATINGS Fire: A class, H class Water pressure: 4 bar Gas pressure: 2.5 bar

Seal	For cable Ø		For hole Ø		Weight		Art. No
	(mm)	(in)	(mm)	(in)	(kg)	(lb)	
RS 25 AISI 316	0+3.6-12	0+0.142-0.472	25-26	0.984 - 1.024	0.04	0.093	RS00100251023
RS 31 AISI 316	0+4-17	0+0.157-0.669	31-32	1.221 - 1.260	0.06	0.132	RS00100311023
RS 43 AISI 316	0+4-23	0+0.157-0.906	43-45	1.693 - 1.772	0.2	0.529	RS00100431023
RS 50 AISI 316	0+8-30	0+0.315-1.181	50-52	1.967 - 2.047	0.3	0.639	RS00100501023

RS seal, with core, acid-proof stainless steel fittings

Seal	For cable Ø		For hole Ø		Weight		Art. No
	(mm)	(in)	(mm)	(in)	(kg)	(lb)	
RS 68 AISI 316	0+26-48	0+1.024-1.890	68-70	2.677 - 2.756	0.5	1.102	RS00100681023
RS 75 AISI 316	0+24-54	0+0.945-2.126	75-77	2.953 - 3.031	0.7	1.543	RS00100751023
RS 100 AISI 316	0+48-70	0+1.890-2.756	100-102	3.937 - 4.016	1.0	2.205	RS00101001023
RS 125 AISI 316	0+66-98	0+2.598-3.858	125-127	4.921 - 5.000	1.6	3.417	RS00101251023

RS seal, without core, acid-proof stainless steel fittings

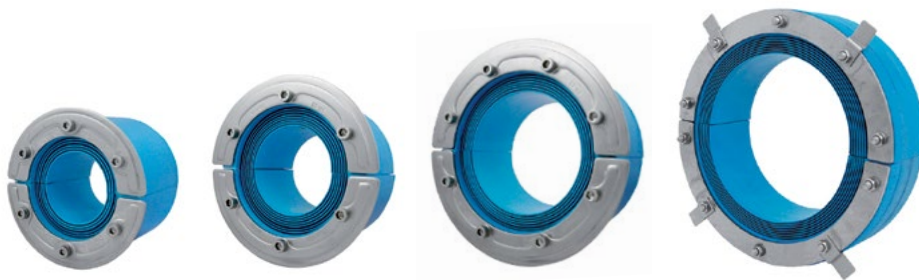

RS 100 AISI 316 woc

RS 125 AISI 316 woc

RS 150 AISI 316 woc

RS 225-250 AISI 316 woc

See sleeves on page 73.
See installation instructions on page 233.
See practical user guidelines on page 264.

RATINGS

Fire: A class, H class

Water pressure: 4 bar

Gas pressure: 2.5 bar

Seal	For cable Ø		For hole Ø		Weight		Art. No
	(mm)	(in)	(mm)	(in)	(kg)	(lb)	
RS 100 AISI 316 woc	48-70	1.890-2.756	100-102	3.937-4.016	0.8	1.874	RS00001001023
RS 125 AISI 316 woc	66-98	2.598-3.858	125-127	4.921-5.000	1.2	2.756	RS00001251023
RS 150 AISI 316 woc	93-119	3.661-4.685	150-152	5.906-5.984	1.6	3.417	RS00001501023
RS 175 AISI 316 woc	119-145	4.685-5.709	175-177	6.890-6.969	2.2	4.189	RS00175750021
RS 200 AISI 316 woc	138-170	5.433-6.693	200-203	7.874-7.992	2.8	5.732	RS00200750021
RS 225 AISI 316 woc	151-181	5.945-7.126	225-228	8.858-8.976	3.1	6.834	RS00002250021
RS 250 AISI 316 woc	176-206	6.913-8.110	250-253	9.843-9.961	3.3	7.275	RS00002500021

RS seal, technical information

RS 25 / RS 31 / RS 43 / RS 50 / RS 68

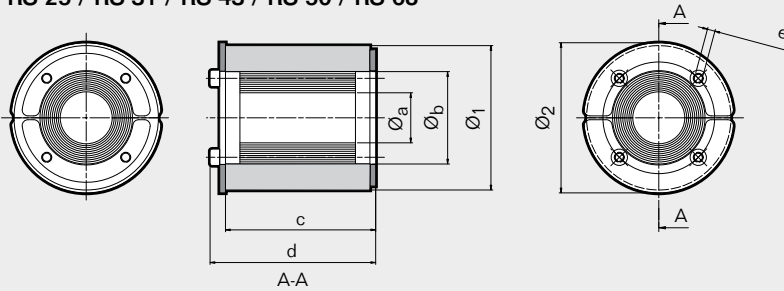

Pos	RS 25		RS 31		RS 43		RS 50		RS 68		RS 75	
	(mm)	(in)	(mm)	(in)	(mm)	(in)	(mm)	(in)	(mm)	(in)	(mm)	(in)
Ø _a	3.6	0.142	4	0.157	4	0.157	8	0.315	26	1.024	24	0.945
Ø _b	12	0.472	17	0.669	23	0.906	30	1.181	48	1.890	54	2.126
Ø ₁	25	0.984	31	1.220	43	1.693	50	1.969	68	2.677	75	2.953
Ø ₂	32	1.260	37	1.457	53	2.087	60	2.362	78	3.071	85	3.346
c	39	1.535	40	1.575	78	3.071	78	3.071	78	3.071	78	3.071
d	43	1.693	44	1.732	85	3.346	85	3.346	85	3.346	85	3.346
e	*	*	*	*	**	**	**	**	**	**	***	***

* SW2.5 mm (4x) / SW0.098" (4x) ** SW4 mm (4x) / SW0.157" (4x) *** SW4 mm (6x) / SW0.157" (6x)

RS 75 / RS 100, RS 100 woc / RS 125, RS 125 woc

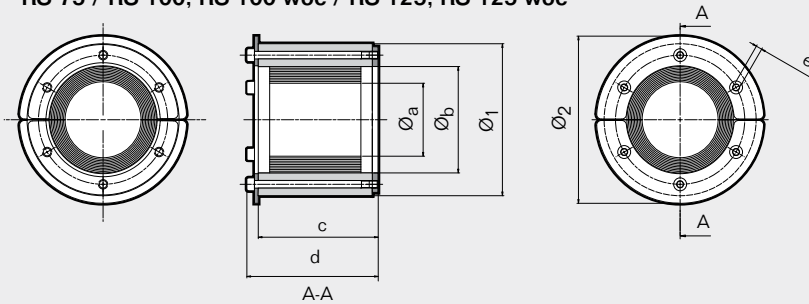

Pos	RS 100 (woc)		RS 125 (woc)	
	(mm)	(in)	(mm)	(in)
Ø _a	48	1.890	66	2.598
Ø _b	70	2.756	98	3.858
Ø ₁	100	3.937	125	4.921
Ø ₂	110	4.331	145	5.709
c	78	3.071	78	3.071
d	87	3.425	87	3.425
e	***	***	****	****

*** SW4 mm (6x) / SW0.157" (6x)

**** SW5 mm (6x) / SW0.197" (6x)

RS 150 woc

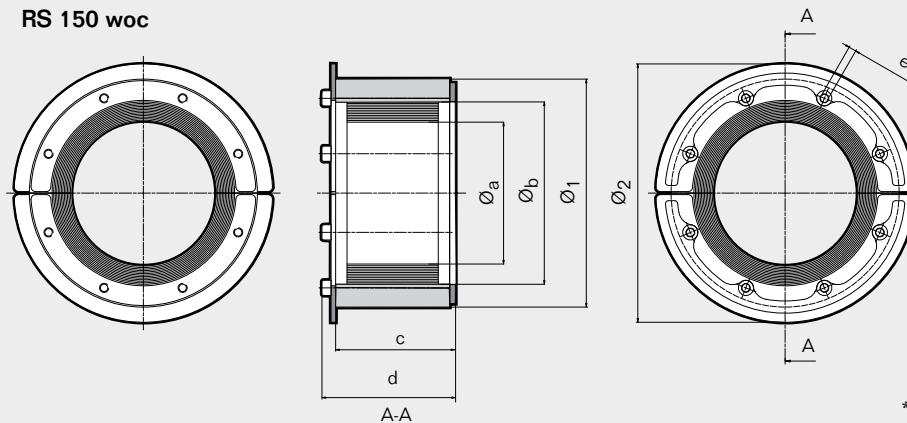

Pos	RS 150 woc	
	(mm)	(in)
Ø _a	93	3.661
Ø _b	119	4.685
Ø ₁	150	5.906
Ø ₂	170	6.693
c	79	3.110
d	88	3.465
e	*****	*****

***** SW5 mm (8x) / SW0.197" (8x)

Note: All dimensions are nominal values

RS seal, technical information

RS 175 woc / RS 200 woc

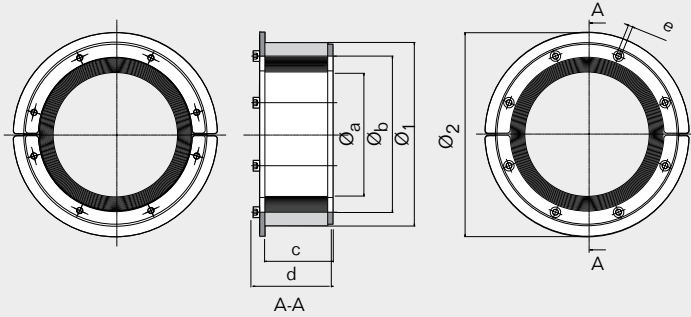

Pos	RS 175 (woc)		RS 200 (woc)	
	(mm)	(in)	(mm)	(in)
Ø _a	119	4.685	138	5.433
Ø _b	147	5.787	170	6.693
Ø ₁	175	6.890	200	7.874
Ø ₂	195	7.677	220	8.661
c	80	3.150	80	3.150
d	90	3.543	90	3.543
e	*	*	*	*

* SW 5 mm (8x) / SW 0.197" (8x)

RS 225 woc / RS 250 woc

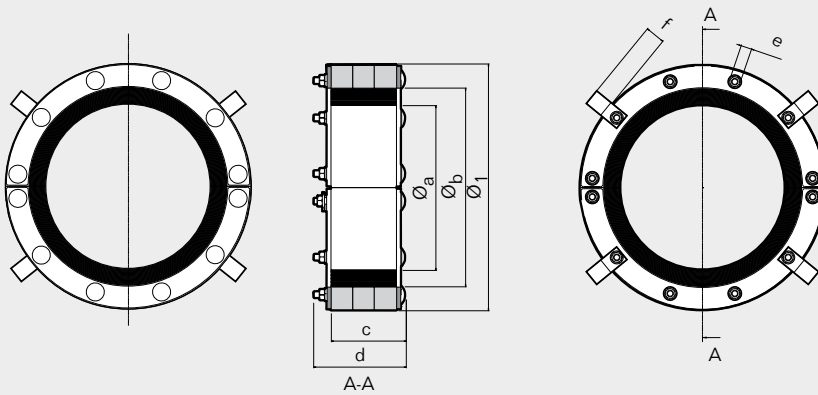

Pos	RS 225 (woc)		RS 250 (woc)	
	(mm)	(in)	(mm)	(in)
Ø _a	151	5.945	176	6.913
Ø _b	181	7.126	206	8.110
Ø ₁	225	8.858	250	9.843
c	68	2.672	69	2.696
d	84	3.302	85	3.326
f	19	0.743	19	0.743
e	**	**	**	**

** SW 10 mm (10x) / SW 0.394" (10x)

Note: All dimensions are nominal values

Sleeves without flange, for RS seal



SLRS primed mild steel



SLRS acid-proof stainless steel



SLRS aluminum

See practical user guidelines on page 264.

Primed mild steel

Sleeve	External dimensions				Internal Ø		Weight		Art. No
	Ø (mm)	Ø (in)	L (mm)	L (in)	(mm)	(in)	(kg)	(lb)	
SLRS 25 primed	34	1.339	35	1.378	25.5	1.004	0.11	0.24	ASL1000250012
SLRS 31 primed	40	1.575	35	1.378	31.5	1.240	0.14	0.30	ASL1000310012
SLRS 43 primed	52	2.047	65	2.559	44	1.732	0.31	0.68	ASL1000430012
SLRS 50 primed	63	2.480	65	2.559	51	2.008	0.54	1.19	ASL1000500012
SLRS 68 primed	83	3.268	65	2.559	69.5	2.736	0.81	1.79	ASL1000680012
SLRS 75 primed	89	3.504	65	2.559	76.5	3.012	0.83	1.83	ASL1000750012
SLRS 100 primed	114	4.488	65	2.559	101	3.976	1.10	2.43	ASL1001000012
SLRS 125 primed	140	5.512	65	2.559	126	4.961	1.50	3.31	ASL1001250012
SLRS 150 primed	164	6.457	65	2.559	151	5.945	1.63	3.58	ASL1001500012
SLRS 175 primed	189	7.441	65	2.559	176	6.929	1.60	3.53	ASLR100017512
SLRS 200 primed	214	8.425	65	2.559	201	7.913	1.80	3.97	ASLR100020012
SLRS 225 primed	239	9.409	55	2.165	227	8.937	1.90	4.19	ASL1002250012
SLRS 250 primed	264	10.394	55	2.165	252	9.921	2.10	4.63	ASL1002500012

Sleeves without flange, for RS seal

Acid-proof stainless steel

Sleeve	External dimensions				Internal Ø		Weight		Art. No
	Ø (mm)	Ø (in)	L (mm)	L (in)	(mm)	(in)	(kg)	(lb)	
SLRS 25 AISI 316	34	1.339	35	1.378	25.5	1.004	0.11	0.24	ASL1000250021
SLRS 31 AISI 316	40	1.575	35	1.378	31.5	1.240	0.14	0.30	ASL1000310021
SLRS 43 AISI 316	52	2.047	65	2.559	44	1.732	0.31	0.67	ASL1000430021
SLRS 50 AISI 316	63	2.480	65	2.559	51	2.008	0.54	1.18	ASL1000500021
SLRS 68 AISI 316	83	3.268	65	2.559	69.5	2.736	0.83	1.83	ASL1000680021
SLRS 75 AISI 316	89	3.504	65	2.559	76.5	3.012	0.83	1.83	ASL1000750021
SLRS 100 AISI 316	114	4.488	65	2.559	101	3.976	1.13	2.49	ASL1001000021
SLRS 125 AISI 316	140	5.512	65	2.559	126	4.961	1.53	3.37	ASL1001250021
SLRS 150 AISI 316	164	6.457	65	2.559	151	5.945	1.63	3.59	ASL1001500021
SLRS 175 AISI 316	189	7.441	65	2.559	176	6.929	1.60	3.53	ASLR101750021
SLRS 200 AISI 316	214	8.425	65	2.559	201	7.913	1.85	4.07	ASLR100020021
SLRS 225 AISI 316	239	9.409	55	2.165	227	8.937	2.20	4.85	5ASL000007919
SLRS 250 AISI 316	264	10.394	55	2.165	252	9.921	2.10	4.63	5ASL000008504

Aluminum

Sleeve	External dimensions				Internal Ø		Weight		Art. No
	Ø (mm)	Ø (in)	L (mm)	L (in)	(mm)	(in)	(kg)	(lb)	
SLRS 25 Alu	34	1.339	35	1.378	25.5	1.004	0.05	0.11	5ASL000004450
SLRS 31 Alu	40	1.575	35	1.378	31.5	1.240	0.03	0.07	5ASL000003374
SLRS 43 Alu	52	2.047	65	2.559	44	1.732	0.10	0.22	5ASL000006302
SLRS 50 Alu	63	2.480	65	2.559	51	2.008	0.09	0.20	5ASL000000663
SLRS 68 Alu	83	3.268	65	2.559	69.5	2.736	0.12	0.26	5ASL000000516
SLRS 75 Alu	89	3.504	65	2.559	76.5	3.012	0.27	0.60	5ASL000000517
SLRS 100 Alu	114	4.488	65	2.559	101	3.976	0.38	0.84	5ASL000001259
SLRS 125 Alu	140	5.512	65	2.559	126	4.961	0.51	1.12	5ASL000000421
SLRS 150 Alu	164	6.457	65	2.559	151	5.945	0.53	1.17	5ASL000000191

Sleeves with flange, for RS seal



SLFRS primed mild steel



SLFRS galvanized mild steel



SLFRS aluminum

See practical user guidelines on page 264.

Primed mild steel

Sleeve	External flange Ø		External dimensions				Internal Ø		Weight		Art. No
	(mm)	(in)	Ø (mm)	Ø (in)	L (mm)	L (in)	(mm)	(in)	(kg)	(lb)	
SLFRS 25 primed	96	3.780	34	1.339	35	1.378	25.5	1.004	0.26	0.58	ASF1000250012
SLFRS 31 primed	102	4.016	40	1.575	35	1.378	31.5	1.240	0.30	0.65	ASF1000310012
SLFRS 43 primed	110	4.331	52	2.047	65	2.559	44	1.732	0.50	1.10	ASF1000430012
SLFRS 50 primed	140	5.512	63	2.480	65	2.559	51	2.008	0.93	2.05	ASF1000500012
SLFRS 68 primed	155	6.102	83	3.268	65	2.559	69.5	2.736	1.23	2.72	ASF1000680012
SLFRS 75 primed	165	6.496	89	3.504	65	2.559	76.5	3.012	1.33	2.93	ASF1000750012
SLFRS 100 primed	195	7.677	114	4.488	65	2.559	101	3.976	1.76	3.87	ASF1001000012
SLFRS 125 primed	213	8.386	140	5.512	65	2.559	126	4.961	2.07	4.56	ASF1001250012
SLFRS 150 primed	236	9.291	164	6.457	65	2.559	151	5.945	2.34	5.16	ASF1001500012
SLFRS 175 primed	255	10.039	189	7.441	65	2.559	176	6.929	2.30	5.07	ASFR101750012
SLFRS 200 primed	290	11.417	214	8.425	65	2.559	201	7.913	2.78	6.13	ASFR100020012
SLFRS 225 primed	320	12.598	239	9.409	55	2.165	227	8.937	3.35	7.39	5ASF000005709
SLFRS 250 primed	345	13.583	264	10.394	55	2.165	252	9.921	3.70	8.16	ASF1002500012

Sleeves with flange, for RS seal

Galvanized mild steel

Sleeve	External flange Ø		External dimensions				Internal Ø		Weight		Art. No
	(mm)	(in)	Ø (mm)	Ø (in)	L (mm)	L (in)	(mm)	(in)	(kg)	(lb)	
SLFRS 25 galv	96	3.780	34	1.339	35	1.378	25.5	1.004	0.26	0.58	ASF1000250015
SLFRS 31 galv	102	4.016	40	1.575	35	1.378	31.5	1.240	0.31	0.68	ASF1000310015
SLFRS 43 galv	110	4.331	52	2.047	65	2.559	44	1.732	0.50	1.10	ASF1000430015
SLFRS 50 galv	140	5.512	63	2.480	65	2.559	51	2.008	0.96	2.11	ASF1000500015
SLFRS 68 galv	155	6.102	83	3.268	65	2.559	69.5	2.736	1.26	2.78	ASF1000680015
SLFRS 75 galv	165	6.496	89	3.504	65	2.559	76.5	3.012	1.35	2.97	ASF1000750015
SLFRS 100 galv	195	7.677	114	4.488	65	2.559	101	3.976	1.79	3.95	ASF1001000015
SLFRS 125 galv	213	8.386	140	5.512	65	2.559	126	4.961	2.13	4.70	ASF1001250015
SLFRS 150 galv	236	9.291	164	6.457	65	2.559	151	5.945	2.41	5.31	ASF1001500015

Aluminum

Sleeve	External flange Ø		External dimensions				Internal Ø		Weight		Art. No
	(mm)	(in)	Ø (mm)	Ø (in)	L (mm)	L (in)	(mm)	(in)	(kg)	(lb)	
SLFRS 25 Alu	96	3.780	96	3.780	35	1.378	25.5	1.004	0.03	0.07	5ASF000008715
SLFRS 31 Alu	102	4.016	102	4.016	35	1.378	31.5	1.240	0.55	1.21	5ASF000002399
SLFRS 43 Alu	110	4.331	110	4.331	65	2.559	44	1.732	0.18	0.40	5ASF000002197
SLFRS 50 Alu	140	5.512	140	5.512	65	2.559	51	2.008	0.31	0.68	5ASF000002198
SLFRS 68 Alu	155	6.102	155	6.102	65	2.559	69.5	2.736	0.40	0.88	5ASF000007125
SLFRS 75 Alu	165	6.496	165	6.496	65	2.559	76.5	3.012	0.43	0.95	5ASF000008716
SLFRS 100 Alu	195	7.677	195	7.677	65	2.559	101	3.976	0.40	0.88	5ASF000004042
SLFRS 125 Alu	213	8.386	213	8.386	65	2.559	126	4.961	0.60	1.32	5ASF000003956
SLFRS 150 Alu	236	9.291	236	9.291	65	2.559	151	5.945	0.80	1.76	5ASF000008717

Openable sleeves with flange, for RS seal



SLFO/RI acid-proof stainless steel

See practical user guidelines on page 264.

Acid-proof stainless steel

Sleeve	External flange diameter		Aperture diameter		Weight		Art. No
	ØA (mm)	ØA (in)	ØB (mm)	ØB (in)	(kg)	(lb)	
SLFO/RI 43 AISI 316	215	8.5	151	5.95	4.2	9.3	SLFORI0004321
SLFO/RI 50 AISI 316	226	8.9	162	6.4	4.7	10.4	SLFORI0005021
SLFO/RI 68 AISI 316	246	9.7	182	7.2	5.4	11.9	SLFORI0006821
SLFO/RI 75 AISI 316	252	9.9	188	7.4	5.5	12.1	SLFORI0007521
SLFO/RI 100 AISI 316	317	12.5	253	9.9	9.5	20.9	SLFORI0010021
SLFO/RI 125 AISI 316	343	13.5	279	10.9	10.8	23.8	SLFORI0012521
SLFO/RI 150 AISI 316	367	14.5	303	11.9	11.6	25.6	SLFORI0015021
SLFO/RI 175 AISI 316	392	15.4	328	12.9	12.6	27.8	SLFORI0017521
SLFO/RI 200 AISI 316	417	16.4	353	13.9	13.7	30.2	SLFORI0020021
SLFO/RI 225 AISI 316	450	17.7	386	15.2	16.8	37.1	SLFORI0022521
SLFO/RI 250 AISI 316	475	18.7	411	16.2	18.1	39.9	SLFORI0025021

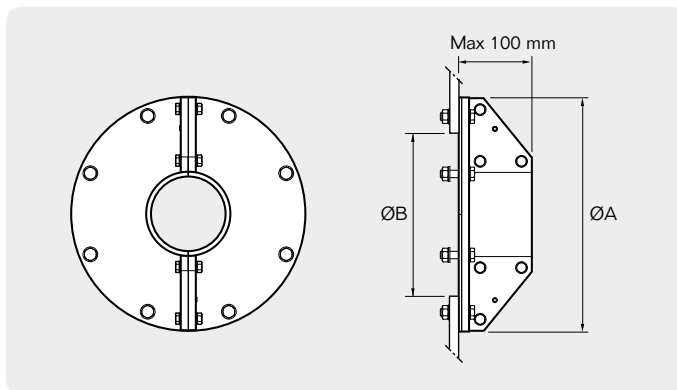



Roxtec RS OMD seal

The Roxtec RS OMD is a round entry seal, consisting of two adaptable halves with removable layers on both the inside and the outside. Compression is integrated in the seal. Allows easy installation around an existing cable.

- Attachment by expansion in holes
- Adaptability on the outside to fit round openings of varying sizes
- For one cable

How it works

The example shows the features that make it quick and easy to install the RS OMD.

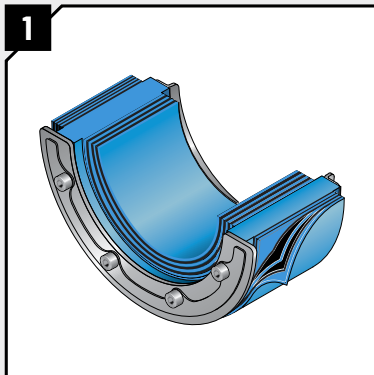

The Roxtec RS OMD has two halves equipped with removable layers on the outside. It can easily be adapted to fit openings of varying sizes and non-standard sleeve sizes.

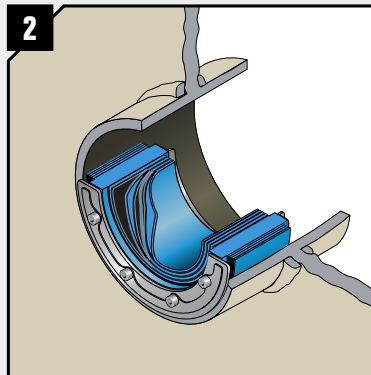

Each half of the seal is also equipped with removable layers inside in order to be adaptable to cables of different sizes.

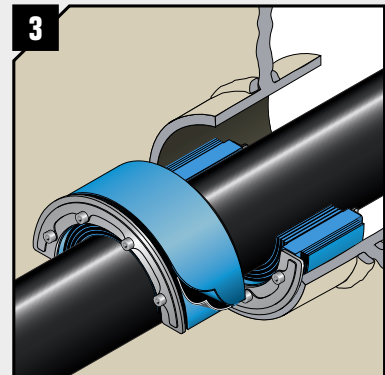

Each half is adapted on the inside and on the outside and the flexible solution is sealed by expansion.

RS OMD seal, acid-proof stainless steel fittings

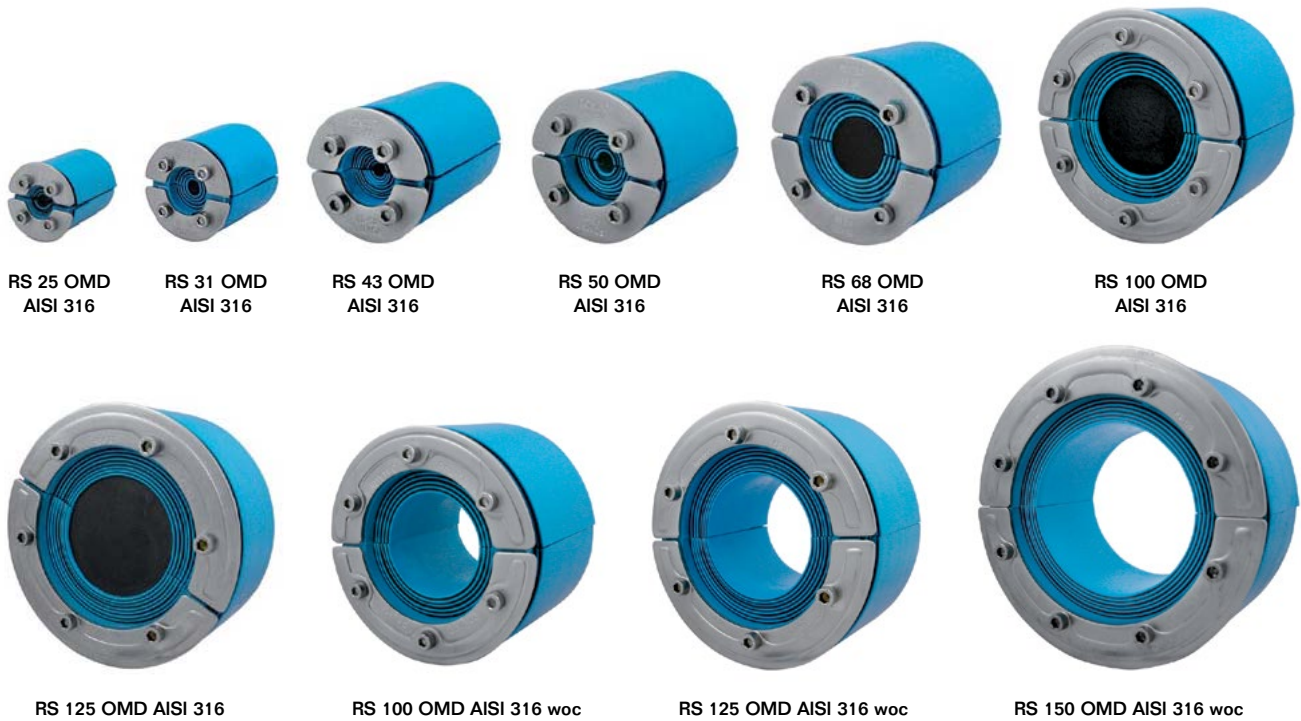

Installation instructions are available on www.roxtec.com

RATINGS Fire: A class Water pressure: 4 bar Gas pressure: 2.5 bar

Seal	For cable Ø		For hole Ø		Weight		Art. No
	(mm)	(in)	(mm)	(in)	(kg)	(lb)	
WITH CORE							
RS 25 OMD AISI 316	0+3,6-12	0+0.142-0.472	25-30	0.984-1.181	0.05	0.121	RSO0100251021
RS 31 OMD AISI 316	0+4-17	0+0.157-0.669	31.5-35.5	1.240-1.398	0.06	0.132	RSO0100311021
RS 43 OMD AISI 316	0+4-23	0+0.157-0.906	43.5-51.0	1.713-2.008	0.2	0.441	RSO0100431021
RS 50 OMD AISI 316	0+8-30	0+0.315-1.181	50.5-58.0	1.988-2.283	0.3	0.661	RSO0100501021
RS 68 OMD AISI 316	0+26-48	0+1.024-1.890	69.0-76.5	2.717-3.012	0.5	1.102	RSO0100681021
RS 100 OMD AISI 316	0+48-70	0+1.890-2.756	101.0-108.0	3.976-4.252	1.0	2.205	RSO0101001021
RS 125 OMD AISI 316	0+66-98	0+2.598-3.858	126.0-143.0	4.961-5.630	1.9	4.058	RSO0101251021
WITHOUT CORE							
RS 100 OMD AISI 316 woc	48-70	1.890-2.756	101.0-108.0	3.976-4.252	0.9	1.984	RSO0001001021
RS 125 OMD AISI 316 woc	66-98	2.598-3.858	126.0-143.0	4.96 -5.630	1.2	2.756	RSO0001251021
RS 150 OMD AISI 316 woc	93-119	3.661-4.685	151.0-168.0	5.945-6.614	1.6	3.417	RSO0001501021

RS OMD seal, technical information

RS 25 OMD / RS 31 OMD / RS 43 OMD / RS 50 OMD / RS 68 OMD

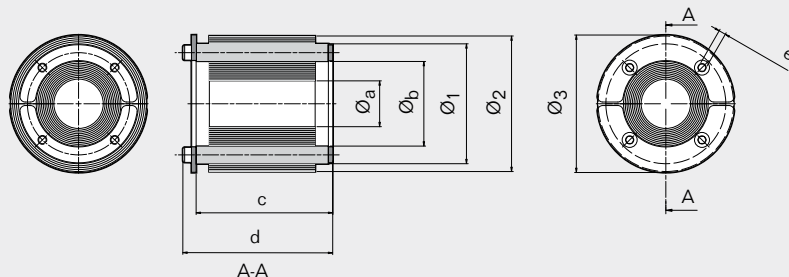

RS 100 OMD / RS 100 OMD woc / RS 125 OMD / RS 125 OMD woc

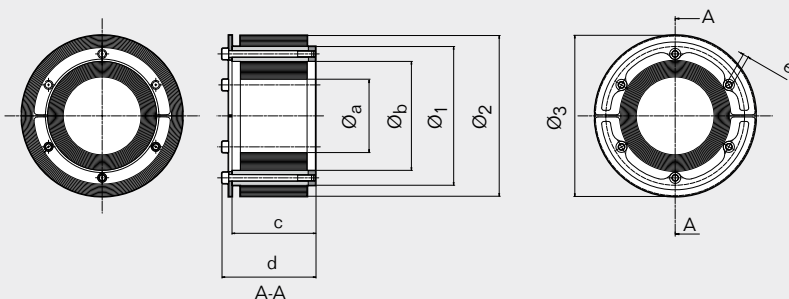

RS 150 OMD / RS 150 OMD woc

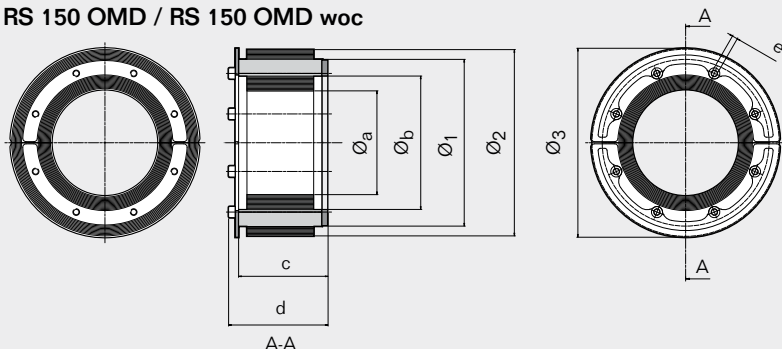

	RS OMD 25		RS OMD 31		RS OMD 43		RS OMD 50		RS OMD 68		RS OMD 100		RS OMD 125		RS OMD 150	
Pos	(mm)	(in)	(mm)	(in)	(mm)	(in)	(mm)	(in)	(mm)	(in)	(mm)	(in)	(mm)	(in)	(mm)	(in)
Ø _a	3.6	0.142	4	0.157	4	0.157	8	0.315	26	1.024	48	1.890	66	2.598	93	3.661
Ø _b	12	0.472	17	0.669	23	0.906	30	1.181	48	1.890	70	2.756	98	3.858	119	4.685
Ø ₁	25	0.984	31	1.220	43	1.693	50	1.969	68	2.677	100	3.937	125	4.921	150	5.906
Ø ₂	30	1.181	36	1.417	51	2.008	58	2.283	76	2.992	108	4.252	143	5.630	168	6.614
Ø ₃	32	1.260	37	1.457	53	2.087	60	2.362	78	3.071	110	4.331	145	5.709	170	6.693
c	38.5	1.516	40	1.575	78	3.071	78	3.071	78	3.071	78	3.071	78	3.071	79	3.110
d	43	1.693	44	1.732	85	3.346	85	3.346	85	3.346	87	3.425	87	3.425	88	3.465
e	*	*	*	*	**	**	**	**	**	**	**	**	**	**	**	**

* SW2.5 mm (4x) / SW0.098" (4x)

**** SW5 mm (6x) / SW0.197 (6x)

** SW4 mm (4x) / SW0.157 (4x)

***** SW5 mm (8x) / SW0.197 (8x)

*** SW4 mm (6x) / SW0.157 (6x)

Note: All dimensions are nominal values



Roxtec R X, RS X seals

The Roxtec R X and RS X solutions are designed for use where welding is not desired. The kit consists of one R or RS seal and one sleeve.

- R X for use with RM modules
- Attachment by expansion
- For one or several cables

How it works

The example shows the features that allow the RS X to be installed in a deck or bulkhead without welding.

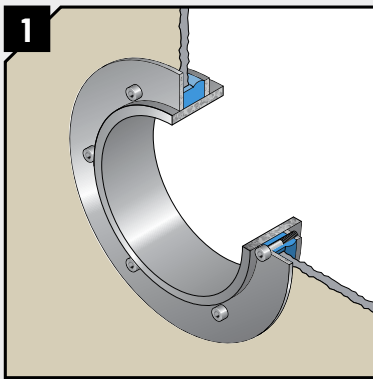

1 The Roxtec RS X is attached through expansion. Its rubber compresses and expands towards the inside of the opening to create tightness between the structure and the SLX sleeve (included in the kit).

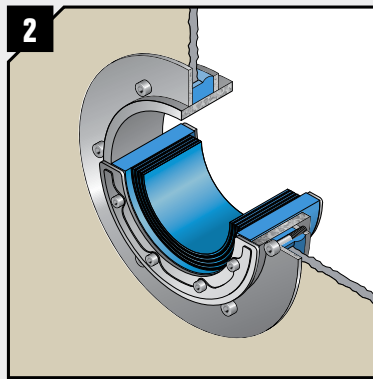

2 The standard operation of the seal also compresses the rubber against the outside of the cable.

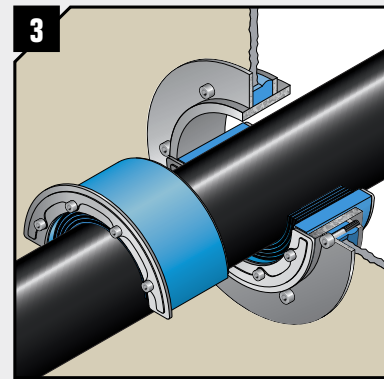

3 Each half of the seal is equipped with removable layers in order to be adaptable to any existing cable.

R X kits, galvanized with galvanized sleeve



R X 100 galv/galv

See information and measurements for R frame on page 65.
See parts needed for a complete solution on page 26.
Installation instructions are available on www.roxtec.com

RATINGS Fire: A class Water pressure: 4 bar Gas pressure: 2.5 bar

Kit	Packing space (mm)	Aperture dim. ± 1 mm (0.0394")		External dimensions sleeve		Weight sleeve		Art. No
		\varnothing (mm)	\varnothing (in)	$\varnothing \times D$ (mm)	$\varnothing \times D$ (in)	(kg)	(lb)	
R X 100 galv/galv	60 x 60	146	5.748	155 x 55	6.102 x 2.165	2.2	4.850	RXG0001001018
R X 125 galv/galv	80 x 80	171	6.732	180 x 55	7.087 x 2.165	2.8	6.173	RXG0001251018
R X 150 galv/galv	90 x 90	200	7.874	209 x 55	8.228 x 2.165	3.5	7.716	RXG0001501018
R X 200 galv/galv	120 x 120	251	9.882	260 x 55	10.236 x 2.165	4.6	10.141	RXG0002001018

R X kits acid-proof stainless steel with galvanized sleeve



R X 100 AISI 316/galv

See information and measurements for R frame on page 65.
See parts needed for a complete solution on page 26.
Installation instructions are available on www.roxtec.com

RATINGS Fire: A class Water pressure: 4 bar Gas pressure: 2.5 bar

Kit	Packing space (mm)	Aperture dim. ± 1 mm (0.0394")		External dimensions sleeve		Weight sleeve		Art. No
		\varnothing (mm)	\varnothing (in)	$\varnothing \times D$ (mm)	$\varnothing \times D$ (in)	(kg)	(lb)	
R X 75 AISI 316/galv	40 x 40	116	4.567	125 x 55	4.921 x 2.165	1.6	3.527	RXG0000751021
R X 100 AISI 316/galv	60 x 60	146	5.748	155 x 55	6.102 x 2.165	2.2	4.850	RXG0001001021
R X 125 AISI 316/galv	80 x 80	171	6.732	180 x 55	7.087 x 2.165	2.8	6.173	RXG0001251021
R X 150 AISI 316/galv	90 x 90	200	7.874	209 x 55	8.228 x 2.165	3.5	7.716	RXG0001501021
R X 200 AISI 316/galv	120 x 120	251	9.882	260 x 55	10.236 x 2.165	4.6	10.141	RXG0002001021

RS X kits, acid-proof stainless steel with galvanized sleeve



RS X 100 AISI 316/galv



RS X 100 AISI 316 woc/galv

See information and measurements for RS seal on page 71.

Installation instructions are available on www.roxtec.com

RATINGS Fire: A class Water pressure: 4 bar Gas pressure: 2.5 bar

Kit	For cable Ø		Aperture dim. ± 1 mm (0.0394")		External dimensions sleeve		Weight		Art. No
	(mm)	(in)	Ø (mm)	Ø (in)	ØxD (mm)	ØxD (in)	(kg)	(lb)	
WITH CORE									
RS X 43 AISI 316/galv	0+4-23	0+0.157-0.906	83	3.268	92 x 65	3.622 x 2.559	0.8	1.764	RSXG100431021
RS X 50 AISI 316/galv	0+8-30	0+0.315-1.181	91	3.583	100 x 65	3.937 x 2.559	1.2	2.646	RSXG100501021
RS X 75 AISI 316/galv	0+24-54	0+0.945-2.126	116	4.567	125 x 65	4.921 x 2.559	1.6	3.527	RSXG100751021
RS X 100 AISI 316/galv	0+48-70	0+1.890-2.756	146	5.748	155 x 65	6.102 x 2.559	2.2	4.850	RSXG101001021
RS X 125 AISI 316/galv	0+66-98	0+2.598-3.858	171	6.732	180 x 65	7.087 x 2.559	2.8	6.173	RSXG101251021
WITHOUT CORE									
RS X 100 AISI 316 woc/galv	48-70	1.890-2.756	146	5.748	155 x 65	6.102 x 2.559	2.2	4.850	RSXG001001021
RS X 125 AISI 316 woc/galv	66-98	2.598-3.858	171	6.732	180 x 65	7.087 x 2.559	2.8	6.173	RSXG001251021
RS X 150 AISI 316 woc/galv	93-119	3.661-4.685	200	7.874	209 x 65	8.228 x 2.559	3.5	7.716	RSXG001501021
RS X 175 AISI 316 woc/galv	119-145	4.685-5.709	221	8.701	230 x 65	9.055 x 2.559	5.03	11.089	RSXG001751021
RS X 200 AISI 316 woc/galv	138-170	5.433-6.693	251	9.882	260 x 65	10.236 x 2.559	6.55	14.440	RSXG002001021

R X, RS X kits, technical information

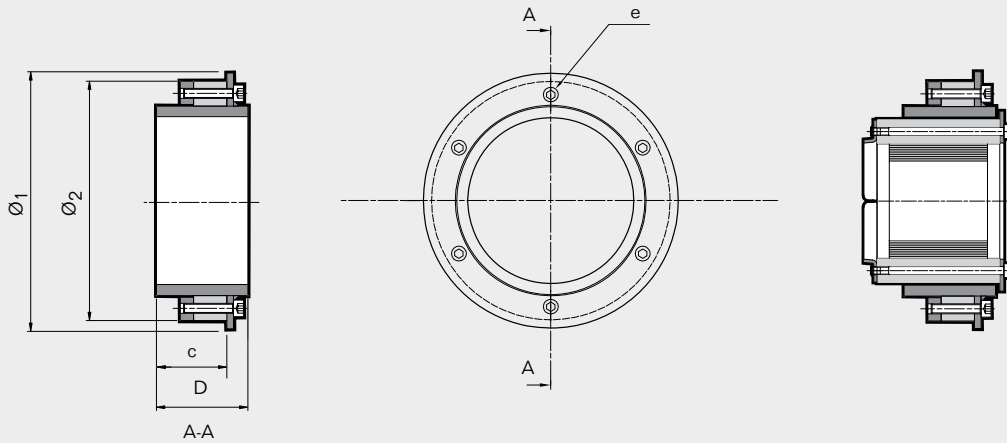

	R X 75		R X 100		R X 125		R X 150		R X 200	
Pos	(mm)	(in)	(mm)	(in)	(mm)	(in)	(mm)	(in)	(mm)	(in)
Ø ₁	125	4.921	155	6.102	180	7.087	209	8.228	260	10.236
Ø ₂	115	4.528	145	5.709	170	6.693	199	7.835	250	9.843
c	43	1.693	43	1.693	43	1.693	43	1.693	43	1.693
D	55	2.165	55	2.165	55	2.165	55	2.165	55	2.165
e	*	*	**	**	**	**	**	**	***	***

* SW 5 mm (4x) / SW 0.197" (4x) ** SW 5 mm (6x) / SW 0.197" (6x) *** SW 5 mm (8x) / SW 0.197" (8x)

	RS X 43		RS X 50		RS X 75		RS X 100 (woc)		RS X 125 (woc)	
Pos	(mm)	(in)	(mm)	(in)	(mm)	(in)	(mm)	(in)	(mm)	(in)
Ø ₁	92	3.622	100	3.937	125	4.921	155	6.102	180	7.087
Ø ₂	82	3.228	90	3.543	115	4.527	145	5.709	170	6.693
c	53	2.087	53	2.087	53	2.087	53	2.087	53	2.087
D	65	2.559	65	2.559	65	2.559	65	2.559	65	2.559
e	****	****	****	****	*****	*****	*****	*****	*****	*****

**** SW 4 mm (4x) / SW 0.157" (4x) ***** SW 5 mm (6x) / SW 0.197" (6x)

	RS X 150 (woc)		RS X 175 (woc)		RS X 200 (woc)	
Pos	(mm)	(in)	(mm)	(in)	(mm)	(in)
Ø ₁	209	8.228	230	9.055	260	10.236
Ø ₂	199	7.835	220	8.661	250	9.843
c	53	2.087	53	2.087	53	2.087
D	65	2.559	65	2.559	65	2.559
e	*****	*****	*****	*****	*****	*****

***** SW 5 mm (6x) / SW 0.197" (6x)

Note: All dimensions are nominal values

Enclosure solutions

Use Roxtec multi-cable entry seals for control cabinets, junction boxes and other electrical and instrumentation enclosures.

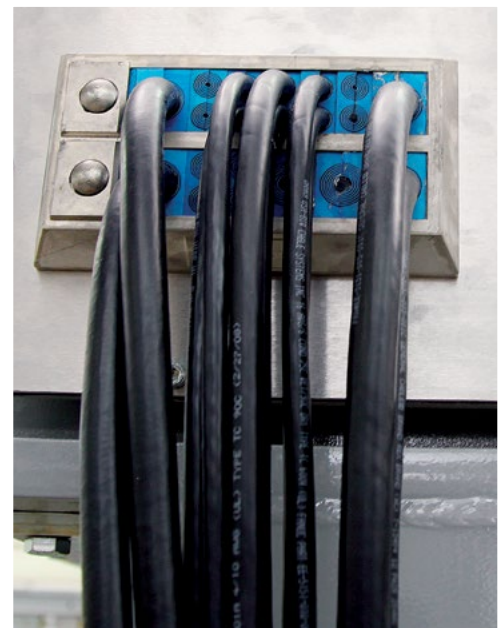

The seals secure and protect equipment within stainless steel, metal, plastic and composite enclosures. Roxtec solutions often pay for themselves by allowing for high cable density which enables designers to reduce the size and weight of the cabinets. The seals are always ready for last minute changes – and you can easily add new cables or change cables in your cabinets. The seals are available in EMC versions.



Roxtec ComSeal™ LW

The Roxtec ComSeal LW is a light-weight and area efficient cable sealing solution for cabinets. The frames are made out of cast aluminum and the solutions are approved for IP 44 and UL/NEMA 3R. They are equipped with adaptable sealing modules and supplied as ready-made kits.

- Available in three different sizes
- For use with Roxtec EM modules
- Attached on inside or outside of cabinet
- Version available for the FL 21 cut-out
- Only for use in enclosures

ComSeal™ LW kits, integrated compression unit, aluminum



ComSeal LW 6



ComSeal LW 12



ComSeal LW 12 FL 21



ComSeal LW 16

See practical user guidelines on page 264.

Installation instructions are available on www.roxtec.com

RATINGS IP: 44 UL/NEMA: 3R

Kit	Diameter range and number of cables			Weight		Art. No
	0+3.5-10.5 mm 0+0.138-0.413 in (EM 15w40)	0+3.5-16.5 mm 0+0.138-0.650 in (EM 20w40)	0+9.5-32.5 mm 0+0.374-1.280 in (EM 40 10-32)	(kg)	(lb)	
ComSeal LW 6/3		2 cables	1 cable	0.322	0.710	107788
ComSeal LW 6/6		6 cables		0.322	0.710	107789
ComSeal LW 6/12	12 cables			0.322	0.710	107790
ComSeal LW 12/3			3 cables	0.445	0.981	107791
ComSeal LW 12/6		4 cables	2 cables	0.445	0.981	107792
ComSeal LW 12/9		8 cables	1 cable	0.445	0.981	107793
ComSeal LW 12/12		12 cables		0.445	0.981	108020
ComSeal LW 12/3 FL 21			3 cables	0.488	1.076	107799
ComSeal LW 12/6 FL 21		4 cables	2 cables	0.488	1.076	107800
ComSeal LW 12/9 FL 21		8 cables	1 cable	0.488	1.076	107802

ComSeal™ LW kits, integrated compression unit, aluminum

Kit	Diameter range and number of cables			Weight		Art. No
	0+3.5-10.5 mm 0+0.138-0.413 in (EM 15w40)	0+3.5-16.5 mm 0+0.138-0.650 in (EM 20w40)	0+9.5-32.5 mm 0+0.374-1.280 in (EM 40 10-32)	(kg)	(lb)	
ComSeal LW 12/12 FL 21		12 cables		0.488	1.076	108018
ComSeal LW 16/4			4 cables	0.536	1.180	107794
ComSeal LW 16/7		4 cables	3 cables	0.536	1.180	107795
ComSeal LW 16/10		8 cables	2 cables	0.536	1.180	107796
ComSeal LW 16/16		16 cables		0.536	1.180	107797

ComSeal™ LW frame, technical information

ComSeal LW 6

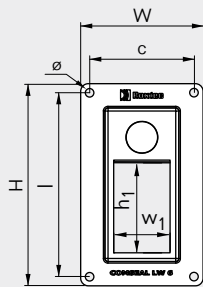

ComSeal LW 12

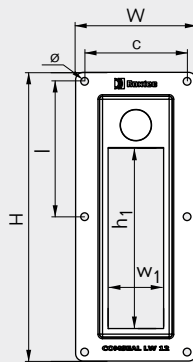

ComSeal LW 12 FL 21

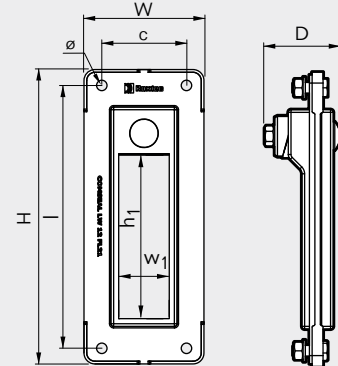

ComSeal LW 16

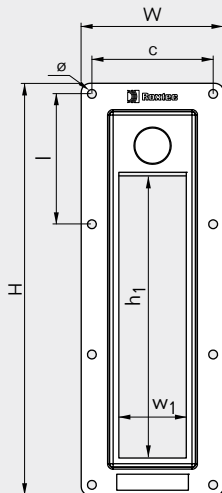

Pos	ComSeal LW 6		ComSeal LW 12		ComSeal LW 12 FL 21		ComSeal LW 16	
	(mm)	(in)	(mm)	(in)	(mm)	(in)	(mm)	(in)
c	68.5	2.697	68.5	2.697	62	2.441	68.5	2.697
D	55	2.165	55	2.165	55	2.165	55	2.165
H	133	5.236	193	7.598	216	8.504	233	9.173
h1	60	2.362	120	4.724	120	4.724	160	6.299
l	121	4.764	90.5	3.583	193	7.598	73.5	2.913
w1	40	1.575	40	1.575	40	1.575	40	1.575
W	80.5	3.169	80.5	3.169	88	3.465	80.5	3.169
ø	5.5	0.217	5.5	0.217	8.5	0.335	5.5	0.217

For ComSeal LW 12 FL 21: If the wall is thinner than 2 mm, a Roxtec ComSeal 12 counter flange 2CV0001020219 is recommended (not supplied in the kit).

Note: All dimensions are nominal values



Roxtec ComSeal™

The Roxtec ComSeal is a light-weight and area efficient cable sealing solution for cabinets. The frames are made out of cast aluminum or cast acid-proof stainless steel, AISI 316, and the solutions are approved for IP 55 and UL/NEMA 3, 12, 12K. They are equipped with adaptable sealing modules and supplied as ready-made kits.

- Available in six different sizes
- For use with Group CM components
- Attached on inside or outside of cabinet
- Only for use in enclosures

ComSeal™ kits, integrated compression unit, aluminum



ComSeal 10

ComSeal 12

ComSeal 15

ComSeal 16

ComSeal 30

ComSeal 32

See installation instructions on page 241.

See practical user guidelines on page 264.

RATINGS IP: 55 UL/NEMA: 3, 12, 12K

Kit	Diameter range and number of cables			Weight		Art. No
	0+3.5-16.5 mm 0+0.138-0.650 in (CM 20W40)	0+9.5-32.5 mm 0+0.374-1.280 in (CM 40 10-32)	0+28-43 mm 0+1.102-1.693 in (CM 50)	(kg)	(lb)	
ComSeal 10/4	2 cables	2 cables		0.515	1.13	105299
ComSeal 10/7	6 cables	1 cable		0.515	1.13	105301
ComSeal 10/10	10 cables			0.515	1.13	105302
ComSeal 12/3		3 cables		0.61	1.34	105303
ComSeal 12/6	4 cables	2 cables		0.61	1.34	105305
ComSeal 12/9	8 cables	1 cable		0.61	1.34	105306
ComSeal 12/12	12 cables			0.61	1.34	105307
ComSeal 15/3			3 cables	0.91	2.0	105308
ComSeal 16/4		4 cables		0.666	1.47	105310

ComSeal™ kits, integrated compression unit, aluminum

Kit	Diameter range and number of cables			Weight		Art. No
	(kg)	(lb)				
	0+3.5-16.5 mm 0+0.138-0.650 in (CM 20W40)	0+9.5-32.5 mm 0+0.374-1.280 in (CM 40 10-32)	0+28-43 mm 0+1.102-1.693 in (CM 50)			
ComSeal 16/7	4 cables	3 cables		0.666	1.47	105312
ComSeal 16/10	8 cables	2 cables		0.666	1.47	105313
ComSeal 16/16	16 cables			0.666	1.47	105314
ComSeal 30/6			6 cables	1.40	3.09	105315
ComSeal 32/8		8 cables		1.259	2.78	105316
ComSeal 32/14	8 cables	6 cables		1.259	2.78	105320
ComSeal 32/20	16 cables	4 cables		1.259	2.78	105321
ComSeal 32/32	32 cables			1.259	2.78	105322

ComSeal™ kits, integrated compression unit, acid-proof stainless steel



ComSeal 10 AISI 316

ComSeal 16 AISI 316

ComSeal 32 AISI 316

See installation instructions on page 241.

See practical user guidelines on page 264.

RATINGS IP: 55 UL/NEMA: 3, 12, 12K

Kit	Diameter range and number of cables		Weight		Art. No
	(kg)	(lb)			
	0+3.5-16.5 mm 0+0.138-0.650 in (CM 20W40)	0+9.5-32.5 mm 0+0.374-1.280 in (CM 40 10-32)			
ComSeal 10/4 AISI 316	2 cables	2 cables	1.096	2.42	105676
ComSeal 10/7 AISI 316	6 cables	1 cable	1.096	2.42	105677
ComSeal 10/10 AISI 316	10 cables		1.096	2.42	105678
ComSeal 16/4 AISI 316		4 cables	1.407	3.11	105679
ComSeal 16/7 AISI 316	4 cables	3 cables	1.407	3.11	105680
ComSeal 16/10 AISI 316	8 cables	2 cables	1.407	3.11	105681
ComSeal 16/16 AISI 316	16 cables		1.407	3.11	105682
ComSeal 32/8 AISI 316		8 cables	2.395	5.28	105683
ComSeal 32/14 AISI 316	8 cables	6 cables	2.395	5.28	105684
ComSeal 32/20 AISI 316	16 cables	4 cables	2.395	5.28	105685
ComSeal 32/32 AISI 316		32 cables	2.395	5.28	105686

ComSeal™ frame, technical information

ComSeal 10

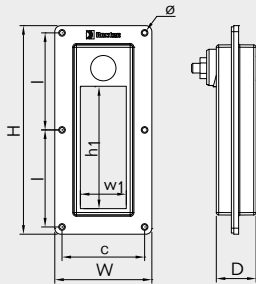

ComSeal 12

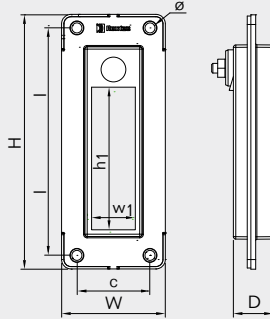

ComSeal 15

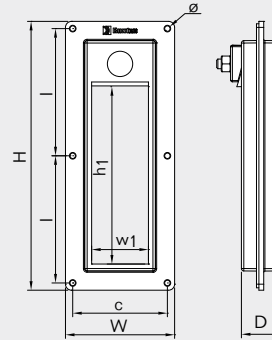

ComSeal 16

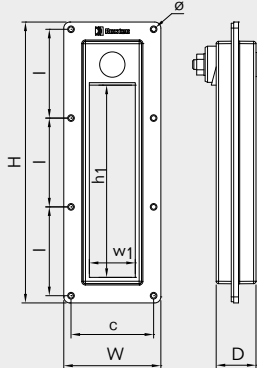

ComSeal 30

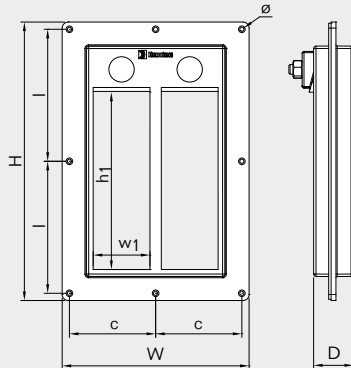

ComSeal 32

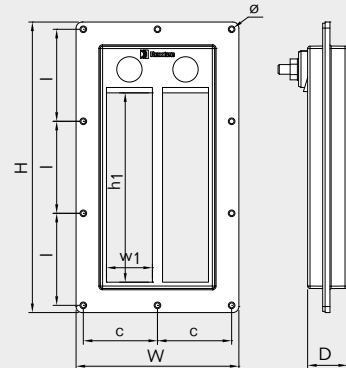

Pos	ComSeal 10		ComSeal 12		ComSeal 15		ComSeal 16		ComSeal 30		ComSeal 32	
	(mm)	(in)	(mm)	(in)	(mm)	(in)	(mm)	(in)	(mm)	(in)	(mm)	(in)
c	68.5	2.697	62	2.441	78.5	3.091	68.5	2.697	71.5	2.815	61.5	2.421
D	33	1.299	33	1.299	33	1.299	33	1.299	33	1.299	33	1.299
H	173	6.811	216	8.504	223	8.780	233	9.173	231	9.094	241	9.488
h ₁	100	3.937	120	4.724	150	5.906	160	6.299	150	5.906	160	6.299
l	80.5	3.169	193	7.598	105.5	4.154	73.7	2.902	109.5	4.311	76.33	3.005
w ₁	40	1.575	40	1.575	50	1.969	40	1.575	50	1.969	40	1.575
W	80.5	3.169	88	3.465	90.5	3.563	80.5	3.169	155	6.102	135	5.315
∅	5.5	0.217	8.5	0.335	5.5	0.217	5.5	0.217	5.5	0.217	5.5	0.217

Roxtec ComSeal 12 fits the FL 21 knock-out.

Note: All dimensions are nominal values



Roxtec CF 8/ CF 32 frames

The Roxtec CF 8 and CF 32 entry seals are made from cast aluminum. Compression unit is integrated in the frame.

- For use with Group CM components
- Attachment by bolting
- Available in kits
- Only for use in enclosures

CF 8/CF 32 frames, integrated compression unit, aluminum



CF 8



CF 32

See parts needed for a complete solution on page 26.

See installation instructions on page 243.

See practical user guidelines on page 264.

RATINGS IP: 66/67 UL/NEMA: 4, 4X, 12, 13

Frame	Frame openings	Packing space (mm)	External dimensions		Weight		Art. No
			HxW (mm)	HxW (in)	(kg)	(lb)	
CF 8	1	40 x 80	140 x 75	5.512 x 2.952	0.6	1.323	CSF0000080035
CF 32	2	40 x 160	230 x 130	9.055 x 5.118	1.4	3.086	CSF0000320035

CF 8/CF 32 kits, integrated compression unit, aluminum



See installation instructions on page 243. See practical user guidelines on page 264.

RATINGS IP: 66/67 UL/NEMA: 4, 4X, 12, 13

Kit	Diameter range and number of cables				External dimensions		Weight		Art. No
	0+3.5-10.5 0+0.138-0.413 (CM 15W40)	0+3.5-16.5 0+0.138-0.650 (CM 20w40)	0+10.0-25.0 0+0.394-0.984 (CM 30w40)	0+9.5-32.5 0+0.374-1.280 (CM 40 10-32)	HxW (mm)	HxW (in)	(kg)	(lb)	
CF 8/5		4 cables		1 cable	140 x 75	5.512 x 2.952	0.7	1.543	CKT8000000005
CF 8/8		8 cables			140 x 75	5.512 x 2.952	0.7	1.543	CKT8000000008
CF 8/9	6 cables	2 cables	1 cable		140 x 75	5.512 x 2.952	0.7	1.543	CKT0000000009
CF 32/20		16 cables		4 cables	230 x 130	9.055 x 5.118	2.0	4.409	CKT3200000020
CF 32/32		32 cables			230 x 130	9.055 x 5.118	2.0	4.409	CKT3200000032
CF 32/41	24 cables	16 cables		1 cable	230 x 130	9.055 x 5.118	2.0	4.409	CKT3200000041

CF 8/CF 32 frames, technical information

CF 8

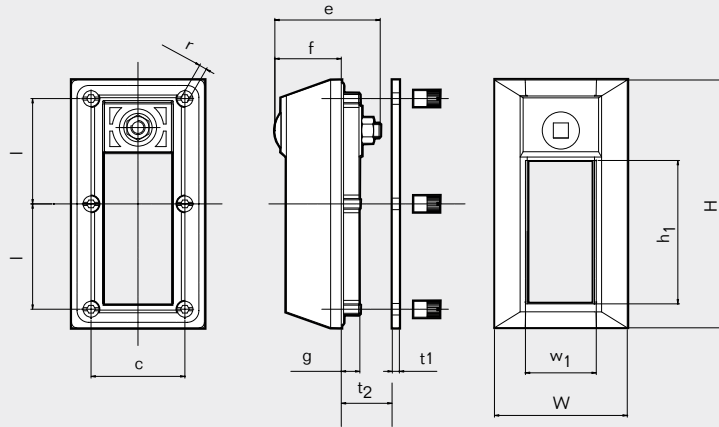

CF 32

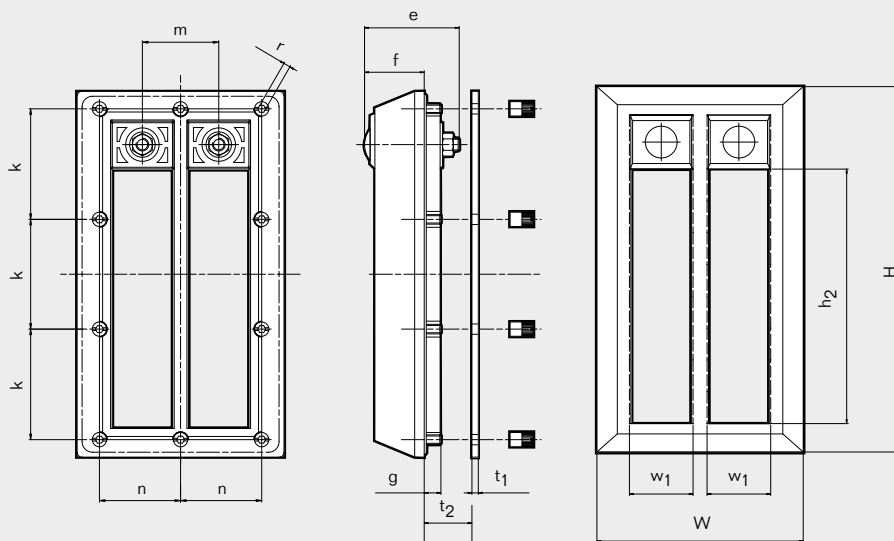

Pos	(mm)	(in)
c	53	2.087
e	59	2.323
f	38	1.496
g	12	0.472
l	60	2.362

Pos	(mm)	(in)
k	70	2.756
m	48	1.890
n	51	2.008
r	SW 4	SW 0.157
t ₁	4	0.157

Pos	(mm)	(in)
t ₂	Wall thickness Max 4	Max 0.157
h ₁	80	3.150
h ₂	160	6.299
w ₁	40	1.575

Note: All dimensions are nominal values



Roxtec KFO frame

The Roxtec KFO is a light-weight composite frame in size 6x1. The frame is openable for easy installation around existing cables.

- For use with Group RM components
- Attachment by bolting
- Available with or without flange
- Only for use in enclosures

KFO frame, PA 6.6, 30% GF - flange, PP



KFO 6x1

KFO 6x1 with flange

See parts needed for a complete solution on page 26.
See practical user guidelines on page 264.
Installation instructions are available on www.roxtec.com

RATINGS

IP: 66/67

Frame	For No. openings	Packing space (mm)	External dimensions		Weight		Art. No
			HxW (mm)	HxW (in)	(kg)	(lb)	
KFO 6x1	1	180 x 120	260 x 159	10.236 x 6.260	1.0	2.094	KFO0000060059
KFO 6x1 with flange	1	180 x 120	420 x 319	16.535 x 12.559	1.6	3.417	KFO1000060059

Available with stainless steel fasteners upon request to meet requirements in aggressive corrosive environments.

KFO frame, technical information

KFO 6x1

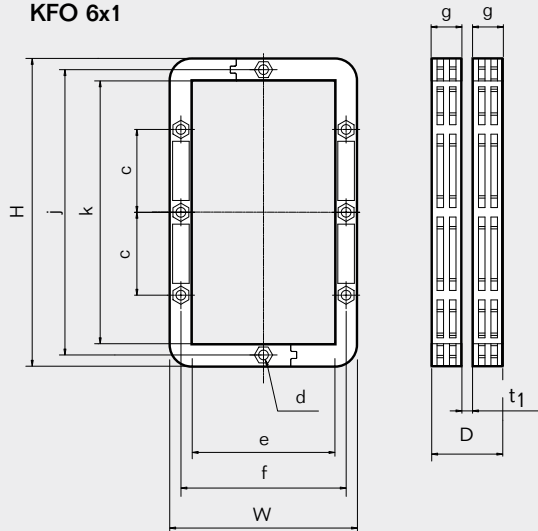

Pos	(mm)	(in)
c	70	2.756
d	Ø 8.2 (8x)	Ø 0.323 (8x)
e	120	4.724
f	140	5.512
g	26	1.024
j	241	9.488
k	222	8.740
t ₁	Wall thickness 5-8	0.197-0.315
D	57-60	2.244-2.362

KFO 6x1 with flange

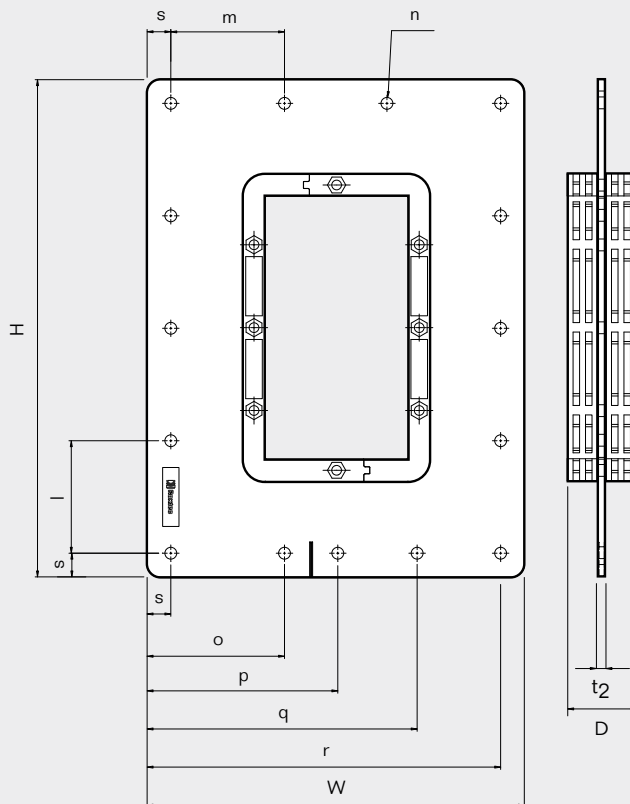

Pos	(mm)	(in)
l	95 (4x)	3.740 (4x)
m	96 (3x)	3.780 (3x)
n	Ø 10 (23x)	Ø 0.394 (23x)
o	116	4.567
p	160	6.299
q	220	8.661
r	299	11.772
s	20	0.787
t ₂	8	0.315
D	60	2.362

Note: All dimensions are nominal values



Roxtec C KFO frame

The Roxtec C KFO is a light-weight composite frame in size 6x1. The frame is openable for easy installation around existing cables.

- For use with Group CM components
- Attachment by bolting
- Available with or without flange
- Only for use in enclosures

C KFO frame, PA 6.6, 30% GF - flange, PP



C KFO 6x1

C KFO 6x1 with flange

C KFO Counter frame

See parts needed for a complete solution on page 26.

See practical user guidelines on page 264.

Installation instructions are available on www.roxtec.com

RATINGS

IP: 55

Frame	For No. openings	Packing space (mm)	External dimensions		Weight		Art. No
			HxW (mm)	HxW (in)	(kg)	(lb)	
C KFO 6x1	1	180 x 120	260 x 159	10.236 x 6.260	0.6	1.323	CKF0000060059
C KFO 6x1 with flange	1	180 x 120	420 x 319	16.535 x 12.559	1.2	2.646	CKF1000060059
C KFO Counter frame*	1	180 x 120	262 x 161	10.315 x 6.338	0.4	0.882	KFC0000100011

*The C KFO Counter frame is recommended if the wall is 1.5 mm (0.059") or thinner.

Available with stainless steel fasteners upon request.

C KFO frame, technical information

C KFO 6x1

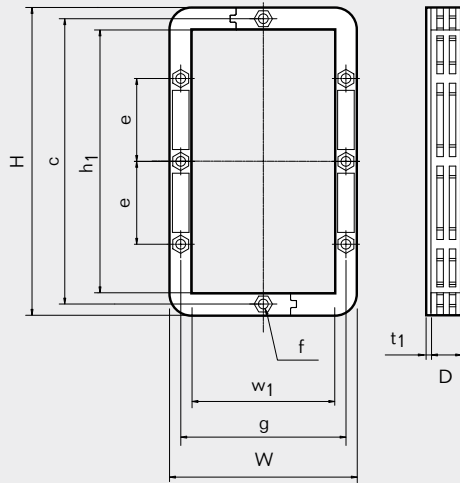

Pos	(mm)	(in)
c	241	9.488
e	70	2.756
f	Ø 8.2 (8x)	Ø 0.323 (8x)
g	140	5.512
h ₁	222	8.740
w ₁	120	4.724
t ₁	gasket	2
D	26	1.024

C KFO 6x1 with flange

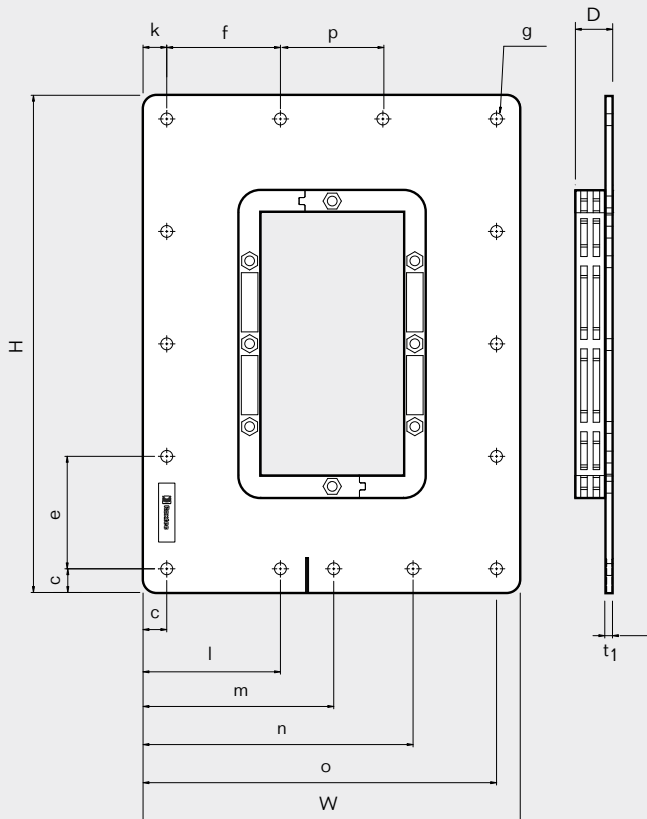

Pos	(mm)	(in)
c	20	0.787
e	95 (4x)	3.740 (4x)
f	96 (2x)	3.780 (2x)
g	Ø 10 (23x)	Ø 0.394 (23x)
l	116	4.567
m	161	6.339
n	228	8.976
o	299	11.772
t ₁	8	0.315
p	87	3.425
D	34	1.339

Note: All dimensions are nominal values



Roxel G frame

The Roxel G frame is a flanged metal frame available with a single opening or in combinations with several openings in width and/or height.

- For use with Group RM components
- Attachment by bolting or welding
- Only for use in enclosures

G frames, primed mild steel



G 6x1 primed

See parts needed for a complete solution on page 26.

See installation instructions on page 222.

See practical user guidelines on page 264.

Remove primer from the inside of the frame to ensure good conductivity in EMC applications.

For information about other frame combinations, or for openable versions of this frame or for versions with wider flanges, please contact your local Roxel supplier or e-mail: info@roxtec.com

RATINGS IP: 66/67 UL/NEMA: 4, 4X, 12, 13

Frame	Frame openings	Packing space (mm)	External dimensions (D=60 mm)		Weight		Art. No
			HxW (mm)	HxW (in)	(kg)	(lb)	
G 2x1 primed	1	60 x 120	233 x 253	9.173 x 9.961	3.4	7.562	G002000000112
G 2x2 primed	2	60 x 120	233 x 383	9.173 x 15.079	5.4	11.905	G002000000212
G 2x3 primed	3	60 x 120	233 x 514	9.173 x 20.236	7.4	16.248	G002000000312
G 2x4 primed	4	60 x 120	233 x 644	9.173 x 25.354	9.3	20.591	G002000000412
G 4x1 primed	1	120 x 120	292 x 253	11.496 x 9.961	4.1	9.039	G004000000112
G 4x2 primed	2	120 x 120	292 x 383	11.496 x 15.079	6.3	13.977	G004000000212
G 4x3 primed	3	120 x 120	292 x 514	11.496 x 20.236	8.6	18.938	G004000000312
G 4x4 primed	4	120 x 120	292 x 644	11.496 x 25.354	10.8	23.898	G004000000412

G frames, primed mild steel

Frame	Frame openings	Packing space (mm)	External dimensions (D=60 mm)		Weight		Art. No
			HxW (mm)	HxW (in)	(kg)	(lb)	
G 4x5 primed	5	120 x 120	292 x 775	11.496 x 30.512	13.1	28.858	G004000000512
G 4x6 primed	6	120 x 120	292 x 905	11.496 x 35.630	15.3	33.797	G004000000612
G 4+4x1 primed	2	120 x 120	461 x 253	18.150 x 9.961	6.6	14.572	G004400000112
G 4+4x2 primed	4	120 x 120	463 x 383	18.228 x 15.079	10.5	23.082	G004400000212
G 4+4x3 primed	6	120 x 120	463 x 514	18.228 x 20.236	14.2	31.305	G004400000312
G 4+4x4 primed	8	120 x 120	463 x 644	18.228 x 25.354	17.9	39.551	G004400000412
G 4+4x5 primed	10	120 x 120	463 x 775	18.228 x 30.512	21.7	47.796	G004400000512
G 4+4x6 primed	12	120 x 120	463 x 905	18.228 x 35.630	25.4	56.019	G004400000612
G 4+4x7 primed	14	120 x 120	463 x 1036	18.228 x 40.787	29.2	64.264	G004400000712
G 4+4x8 primed	16	120 x 120	463 x 1166	18.228 x 45.906	32.9	72.509	G004400000812
G 4+4x9 primed	18	120 x 120	463 x 1297	18.228 x 51.063	36.6	80.732	G004400000912
G 4+4x10 primed	20	120 x 120	463 x 1427	18.228 x 56.181	40.4	88.979	G004400001012
G 4+4+4x1 primed	3	120 x 120	631 x 253	24.843 x 9.961	9.1	20.106	G004440000112
G 6x1 primed	1	180 x 120	350 x 253	13.780 x 13.961	4.8	10.516	G006000000112
G 6x2 primed	2	180 x 120	350 x 383	13.780 x 15.079	7.3	16.072	G006000000212
G 6x3 primed	3	180 x 120	350 x 514	13.780 x 20.236	9.8	21.627	G006000000312
G 6x4 primed	4	180 x 120	350 x 644	13.780 x 25.354	12.3	27.205	G006000000412
G 6x5 primed	5	180 x 120	350 x 775	13.780 x 30.512	14.9	32.760	G006000000512
G 6x6 primed	6	180 x 120	350 x 905	13.780 x 35.630	17.4	38.316	G006000000612
G 6+6x1 primed	2	180 x 120	578 x 253	22.756 x 9.961	8.0	17.527	G006600000112
G 6+6x2 primed	4	180 x 120	580 x 383	22.835 x 15.079	12.4	27.249	G006600000212
G 6+6x3 primed	6	180 x 120	580 x 514	22.835 x 20.236	16.6	36.707	G006600000312
G 6+6x4 primed	8	180 x 120	580 x 644	22.835 x 25.354	20.9	46.142	G006600000412
G 6+6x5 primed	10	180 x 120	580 x 775	22.835 x 30.512	25.2	55.601	G006600000512
G 6+6x6 primed	12	180 x 120	580 x 905	22.835 x 35.630	29.5	65.059	G006600000612
G 6+6x7 primed	14	180 x 120	580 x 1036	22.835 x 40.787	33.8	74.515	G006600000712
G 6+6x8 primed	16	180 x 120	580 x 1166	22.835 x 45.906	38.1	83.973	G006600000812
G 6+6x9 primed	18	180 x 120	580 x 1297	22.835 x 51.063	42.4	93.409	G006600000912
G 6+6x10 primed	20	180 x 120	580 x 1427	22.835 x 56.181	46.7	102.867	G006600001012
G 6+6+6x1 primed	3	180 x 120	806 x 253	31.732 x 9.961	11.1	24.538	G006660000112
G 8x1 primed	1	240 x 120	410 x 253	16.142 x 9.941	5.5	12.037	G008000000112
G 8x2 primed	2	240 x 120	410 x 383	16.142 x 15.079	8.3	18.210	G008000000212
G 8x3 primed	3	240 x 120	410 x 514	16.142 x 20.236	11.1	24.405	G008000000312
G 8x4 primed	4	240 x 120	410 x 644	16.142 x 25.354	13.9	30.578	G008000000412

G frame, acid-proof stainless steel



G 6x1 AISI 316

See parts needed for a complete solution on page 26.

See installation instructions on page 222.

See practical user guidelines on page 264.

For information about other frame combinations, or for openable versions of this frame or for versions with wider flanges, please contact your local Roxtec supplier or e-mail: info@roxtec.com

RATINGS

IP: 66/67

UL/NEMA: 4, 4X, 12, 13

Frame	Frame openings	Packing space (mm)	External dimensions (D=60 mm)		Weight		Art. No
			HxW (mm)	HxW (in)	(kg)	(lb)	
G 2x1 AISI 316	1	60 x 120	233 x 253	9.173 x 9.961	3.4	7.562	G002000000121
G 4x1 AISI 316	1	120 x 120	292 x 253	11.496 x 9.961	4.1	9.039	G004000000121
G 4x2 AISI 316	2	120 x 120	292 x 383	11.496 x 15.079	6.3	13.977	G004000000221
G 4x3 AISI 316	3	120 x 120	292 x 514	11.496 x 20.236	8.6	18.938	G004000000321
G 4x4 AISI 316	4	120 x 120	292 x 644	11.496 x 25.354	10.8	23.898	G004000000421
G 6x1 AISI 316	1	180 x 120	350 x 253	13.780 x 9.961	4.8	10.516	G006000000121
G 6x2 AISI 316	2	180 x 120	350 x 383	13.780 x 15.079	7.3	16.072	G006000000221
G 6x3 AISI 316	3	180 x 120	350 x 514	13.780 x 20.236	9.8	21.627	G006000000321
G 6x4 AISI 316	4	180 x 120	350 x 644	13.780 x 25.354	12.4	27.205	G006000000421
G 8x1 AISI 316	1	240 x 120	410 x 253	16.142 x 9.941	5.5	12.037	G008000000121
G 8x2 AISI 316	2	240 x 120	410 x 383	16.142 x 15.079	8.3	18.210	G008000000221
G 8x3 AISI 316	3	240 x 120	410 x 514	16.142 x 20.236	11.1	24.405	G008000000321
G 8x4 AISI 316	4	240 x 120	410 x 644	16.142 x 25.354	13.9	30.578	G008000000421

G frame, technical information

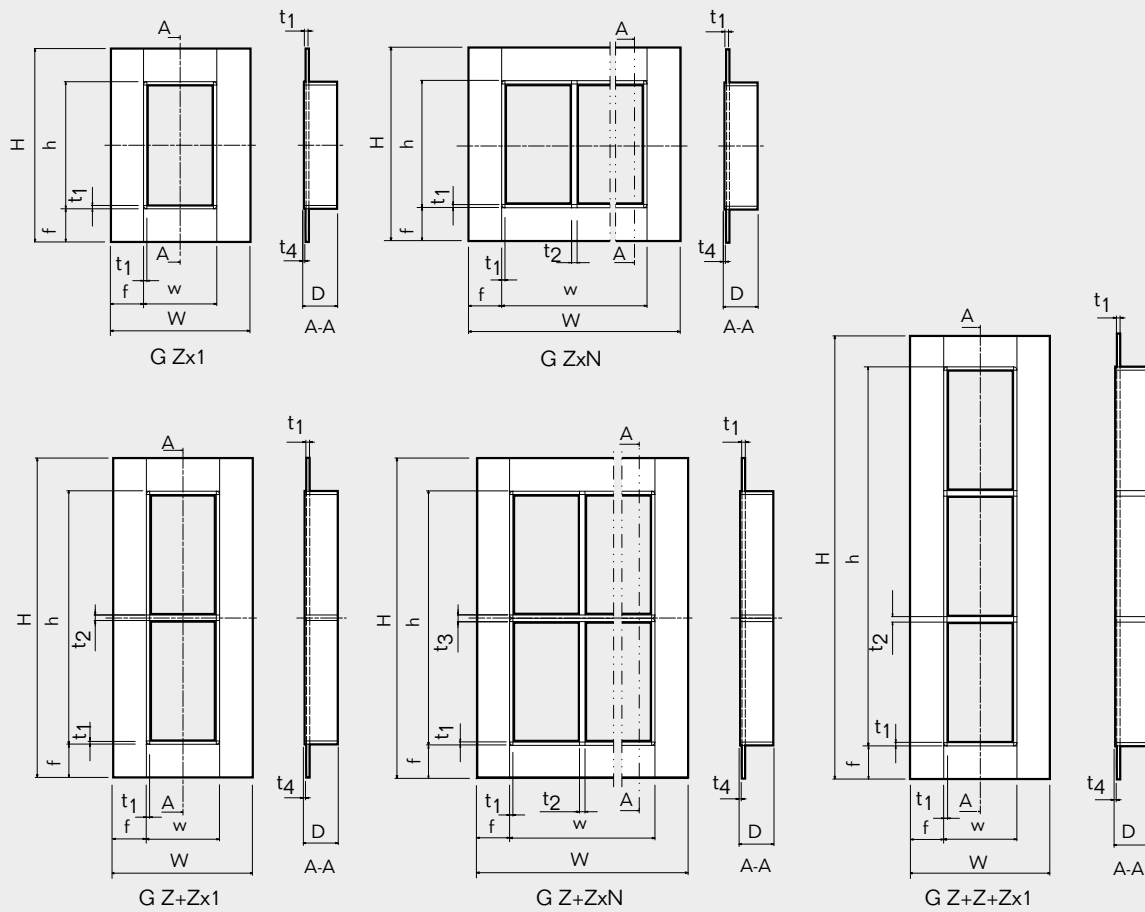

Pos	(mm)	(in)
h	H - 120	H - 4.724
w	W - 120	W - 4.724
D	60	2.362
f	60	2.362
t1	6	0.263
t2	10	0.394
t3	12	0.394
t4	3	0.118

Z = Frame size
N = Number of horizontal openings

Note: All dimensions are nominal values



EMC SEALING SYSTEM



Electromagnetic compatibility

The use of sophisticated equipment onboard vessels has increased and resulted in an extensive need for protection against electromagnetic interference (EMI).

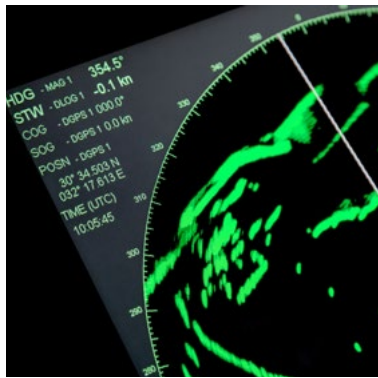

The impact from EMI can be difficult to foresee and can range from harmless symptoms to a severe issue arising from an initial exposure inside a control or safety system. EMI sources capable of causing such issues or levels of disturbance may be unpredictable and also numerous in the many routes they take. Therefore, EMC is a two-way thinking process. You have to make sure your equipment is not directly affected or impaired by various sources of EMI, and also make sure it operates effectively in its intended environment without becoming the disturbing

source of EMI for other technologies or equipment.

Combined protection

The Roxtec EMC product range for EMI protection can combine this with protection against fire, smoke, water, gas, explosion, vibration, dust and dirt. Every cable penetration has its own unique set of risk priorities in respect of its protection requirements. Even when EMC is the core concern, other levels of required protection are not compromised as a result of mitigating the EMI risk.

On a ship, where it is a great concern to ensure personal safety and protect large financial investments, owners can feel safe in the knowledge that the Roxtec EMC product range is performing multiple risk prevention functions at the same time.

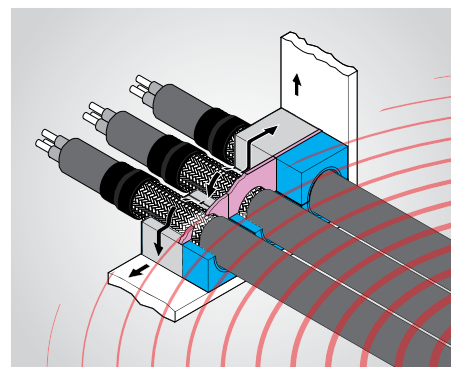
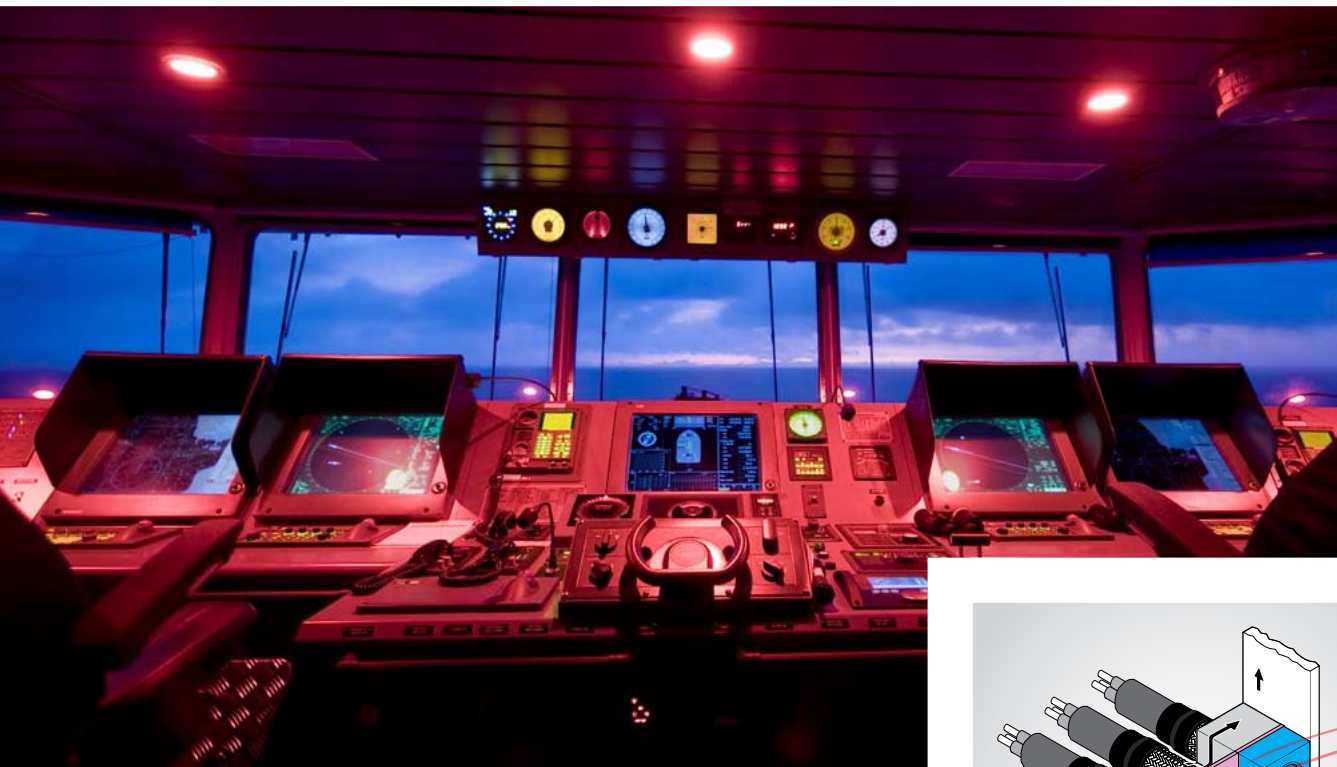

Electromagnetic threats

There are natural phenomena such as lightning strikes, but also predictable causes of interference from radar, wireless communication systems and side effects from switching devices or technical systems such as propulsion systems. Intentional electromagnetic interference and high power microwave (HPM) technology have also become threats that generate a great deal of concern. Electromagnetic disturbances have many different origins, but only two forms of travel. They are either conducted along a metallic object or propagate through air. It is also possible that one single source generates both forms of disturbance.

Increased EMI exposure

Marine vessels have miles of cables running through their whole structure. With advances in technology generating more and more sophisticated ships, the volumes and variations of different types of cables onboard are also growing.

A material that can conduct electricity can also transport unwanted signals. The armor in an armored cable can pick up and carry signals throughout its whole length and cause interference in a system far away from the original source. This means that normal working environments can generate EMI exposure and this risk is important for designers, engineers and owners to consider.

Required features

In order to eliminate such risks and achieve electromagnetic compatibility, ground connections must be as short as possible and have large contact areas exposed to its mating surface. With flat and wide conductors (tin-plated copper tape or braid) and barriers embedded inside the sealing module, the Roxtec EMC solutions ensure the very best properties over the full frequency spectra.



Plan for EMC to reduce risk and cost

Bonding and grounding solutions for electrical safety requirements such as protective earthing, equipotential bonding and lightning protection cannot be managed independently without considering EMC aspects. Including EMC into the initial electrical design is a way to avoid impairing or compromising the performance of any EMC solution by having to add it at a later stage. Malfunction of systems due to EMI can cause severe operational difficulties and trying to identify EMC problems and track the cause after the event is a difficult process. Predefining electromagnetic zones is a help to decide for a specific penetration where earthing is sufficient or where full electromagnetic shielding is required. A stage by stage approach to identify EMI requirements will enable a cumulative view in identifying the applicable solutions required along the route of the cable.

Only as strong as the weakest link

Roxtec EMI solutions are capable of managing a tight and compressed fit against both sides of a stripped braided armored cable. If not, one half of the cable security would be compromised. A strong and consistent connection to the cable armor is one of the keys for maximizing the EMI protection. With Multidiameter™, upfront knowledge of the exact dimension of each cable is not that important as the Roxtec BG/EMC products are separately adaptable to obtain the correct fit for both the outer sheet of the cable and the armor/shield. Roxtec products also support best practice EMI protection principles by providing a single entry and by having the earth path integrated within the cable entry. The use of combination frames with several openings simplifies the issue of cable segregation in order to avoid cable to cable interference.

Bonding and grounding for EMC

Cable armor, shields or screens all need to be connected to earth, but traditional earthing methods may be ineffective as earth paths for higher frequencies. Flattened braids are commonly used to resolve this problem by combining large copper masses in a flat form to deliver better high frequency properties than a circular conductor.

Embedded braid

The Roxtec BG B/BG solution addresses this issue by having a braid embedded in the seal. It is fitted at the point of cable entry and surrounded by the solid metal frame. Applying such methods for all earthing needs ensures that total EMC requirements are met.

The robust, but still flexible design of the Roxtec solution

- works very well with rigid and irregular cable armor
- withstands high currents if a fault occurs within the system
- withstands surges from lightning strikes
- is an effective protection against conducted interference.

Electromagnetic shielding

To prevent very high frequencies from disturbing equipment, electromagnetically sealed enclosures and compartments are used.

All cables going in or out from them have to be shielded and connected to earth, and cables with tight shields are required to protect inner conductors from interfering signals. In addition, the gaps between each cable have to

be electromagnetically sealed so the cable entry solution operates as an extension of the conductive wall. This prevents conducted and radiated electromagnetic signals from penetrating the enclosure wall.

The Roxtec ES B/ES solutions achieve this by having a barrier in each module sealing the gaps between the cable shield and the frame, or via the adjacent modules. The seals are tested to a minimum of 18GHz to prove the shielding effectiveness. Transfer impedance from cable shield to frame is also measured up to 30MHz.

Electromagnetic threats

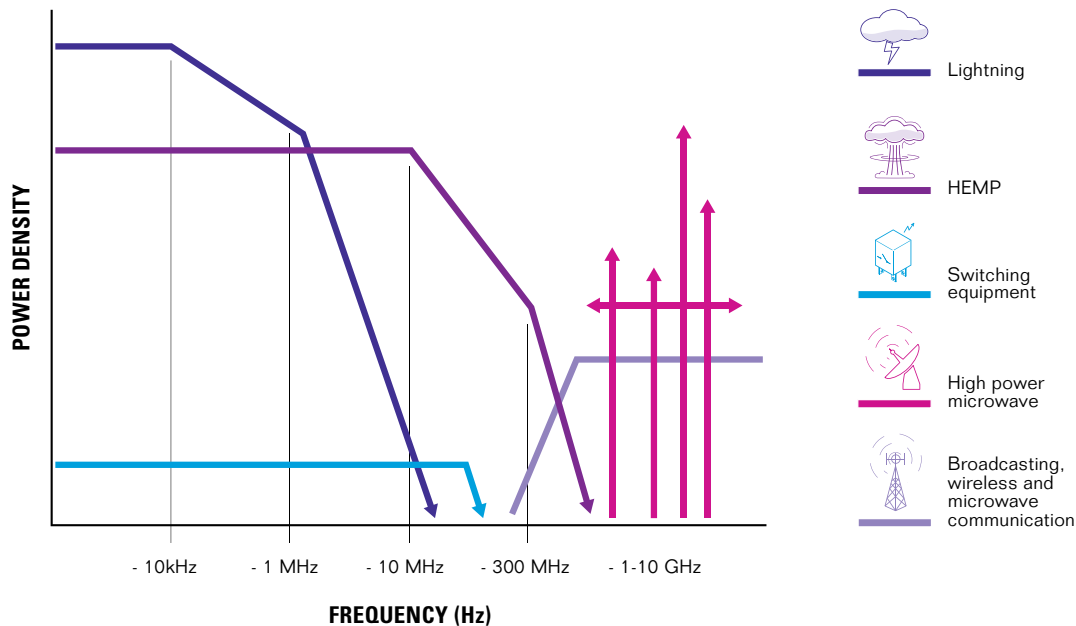

Typical EMC application areas



Terminal and junction boxes

By using the compact versions of Roxtec EMC solutions, you can easily ensure area efficiency and electromagnetic compatibility in connections points all over the ship.



Control cabinets

Roxtec compact EMC seals shield and protect. They also allow the use of pre-terminated cables and provide built-in spare capacity for future modifications.

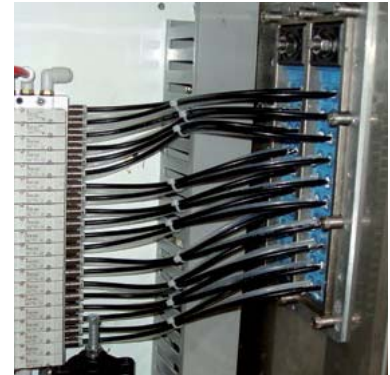

Communication area

RFI-shielded EMC solutions from Roxtec provide EMI protection for sensitive equipment as well as protection against fire, gas, smoke, water and vibration.



Motors, converters and switchgear

Ensure continuous operation with Roxtec EMC solutions for frequency converters, remote I/O and other disturbing or sensitive equipment, and combine IP ratings with protection against electromagnetic threats.



Outdoor deck area

Roxtec EMC solutions can be used in corrosive environments to ensure both environmental and EMI protection – a safe way to secure antennas and functionality in case of lightning strikes.



Bulkhead, deck and floor penetrations

Roxtec provides frames with rounded corners to reduce stress in bulkheads. This transit combines electromagnetic shielding with certified protection against fire, smoke and water.

Roxtec modules for EMC

Roxtec full length modules are available for both single- and double-sided environmental protection while the shorter modules are available for single-sided environmental protection.

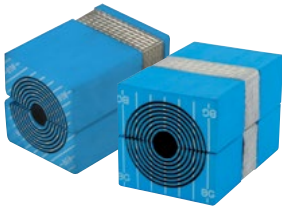

Roxtec BG B™/BG™

The BG B/BG product family is designed for bonding and grounding of armored and shielded cables. By design it also protects against conducted interference. The tin-plated copper braid shapes perfectly to the irregularities of the metallic armor and provides substantial copper mass to withstand high fault currents or surges from for example lightning strikes.

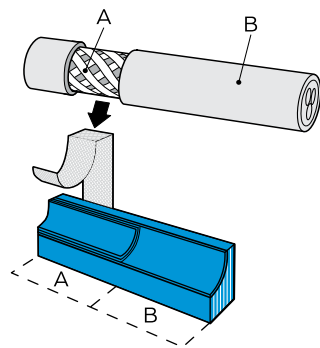

Section of a BG B module

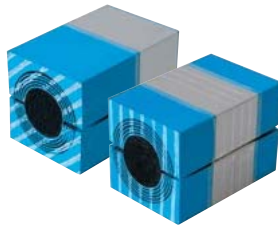

Roxtec ES B/ES

The ES B/ES product family is designed for shielded or screened cables where electromagnetic shielding is required in the cable entry. The low-impedance path from cable screen to earth eliminates conducted interference and provides at the same time a conductive barrier that efficiently prevents electromagnetic fields from penetrating the seal. The ES B/ES is intended for use with high quality shielded cables for entries into shielded environments such as enclosures or compartments of the ship.

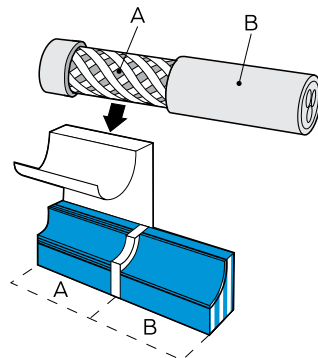

Section of an ES B module

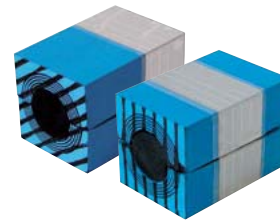

Roxtec PE B/PE

The PE B/PE products protect against conducted interference and are primarily intended for cables with braided and foil screens where current withstand capabilities and electromagnetic shielding are of less importance.

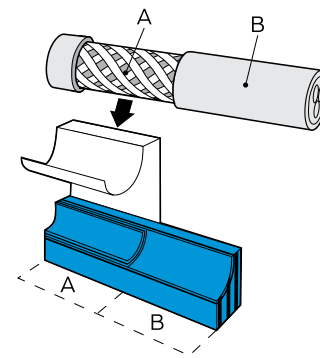

Section of a PE B module

Using the right cable and system

Cable constructions and types vary across the world, and the cables are designed with various specific purposes in mind. The fact that all Roxtec EMC products contact the first metallic layer, armor, screen or shield under the insulation influences the selection and installation of the correct products and frames.

Cable armor can be very rigid and made of corrugated aluminum or steel wires as its primary purpose is to provide mechanical protection. Other armor can be made of braided copper wires for

applications where flexibility is key. The tighter the braiding, the better electromagnetic shielding is achieved.

There are also cables with very thin screens of metallic foils for pure electromagnetic shielding and cable armor of copper wires with the function of being the return path for fault current, the protective earthing conductor. Therefore, it is important that the right cables are chosen for their intended purpose and installed in line with the intent.

The selection of what EMC seal-

ing system to use can be based on the expected cable or pipe type. If the application uses an armored cable, electrical safety must be considered meaning that a BG B/BG system is recommended. If the cables are shielded it is more likely an EMI application where the ES B/ES or PE B/PE system should be used. With the ES B/ES system, waveguide techniques can be applied when non-metallic fiber optic cables and plastic pipes or hoses run through an ES B/ES system into shielded environments.

EMC sealing system selection guide

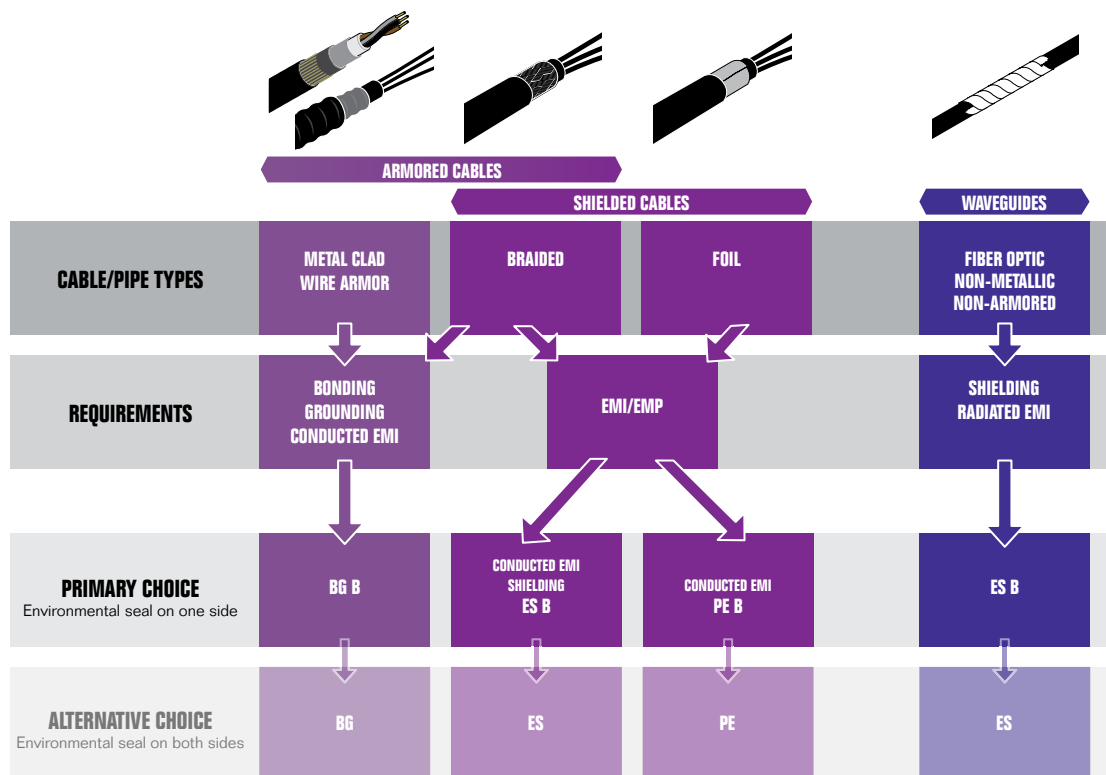

Pipes can use any module type depending on protection required.

See disclaimer on page 291.

Roxtec RM BG™ B modules



RM 40 10-32 BG B
– front view

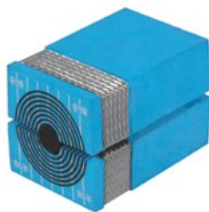

RM 40 10-32 BG B
– back view

See information and measurements on page 30.

For information about other module sizes, please contact your local Roxtec supplier or e-mail: info@roxtec.com

Module	Number of cables/pipes	For cable/pipe diameter		External dim. (mm) HxW (D=60 mm)	Weight		Art. No
		Ø _a -Ø _b (mm)	Ø _a -Ø _b (in)		(kg)	(lb)	
WITH CORE							
RM 20 BG B	1	0+4.0-14.5	0+0.157-0.571	20x20	0.04	0.088	103329
RM 20w40 BG B	2	0+3.5-16.5	0+0.138-0.650	20x40	0.07	0.154	103331
RM 30 BG B	1	0+10.0-25.0	0+0.394-0.984	30x30	0.08	0.176	103332
RM 40 10-32 BG B	1	0+9.5-32.5	0+0.374-1.280	40x40	0.14	0.309	103333
RM 60 24-54 BG B	1	0+24.0-54.0	0+0.945-2.126	60x60	0.33	0.728	103336
WITHOUT CORE							
RM 80 BG B woc	1	48.0-71.0	1.890-2.795	80x80	0.46	1.014	118502
RM 90 BG B woc	1	48.0-71.0	1.890-2.795	90x90	0.56	1.235	103338
RM 120 BG B woc	1	67.5-99.0	2.657-3.898	120x120	0.94	2.072	103313

Roxtec RM BG™ modules

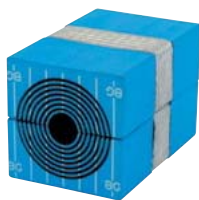

RM 40 10-32 BG

See information and measurements on page 30.

For information about other module sizes, please contact your local Roxtec supplier or e-mail: info@roxtec.com

Module	Number of cables/pipes	For cable/pipe diameter		External dim. (mm) HxW (D=60 mm)	Weight		Art. No
		Ø _a -Ø _b (mm)	Ø _a -Ø _b (in)		(kg)	(lb)	
WITH CORE							
RM 20 BG	1	0+4.0-14.5	0+0.157-0.571	20x20	0,04	0.088	102415
RM 20w40 BG	2	0+3.5-16.5	0+0.138-0.650	20x40	0.07	0.154	102416
RM 30 BG	1	0+10.0-25.0	0+0.394-0.984	30x30	0.08	0.176	102417
RM 40 10-32 BG	1	0+9.5-32.5	0+0.374-1.280	40x40	0.14	0.309	102419
RM 60 24-54 BG	1	0+24.0-54.0	0+0.945-2.126	60x60	0.33	0.728	102422
WITHOUT CORE							
RM 80 BG woc	1	48.0-71.0	1.890-2.795	80x80	0.46	1.014	118505
RM 90 BG woc	1	48.0-71.0	1.890-2.795	90x90	0.56	1.235	102424
RM 120 BG woc	1	67.5-99.0	2.657-3.898	120x120	0.94	2.072	102412

Roxtec RM BG™ B, RM BG™ solid compensation modules

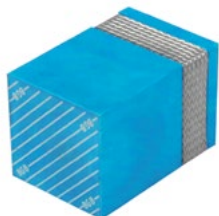

RM 40/0 BG B
– front view

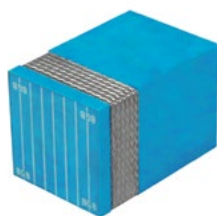

RM 40/0 BG B
– back view

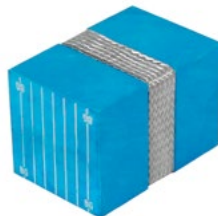

RM 40/0 BG

See information and measurements on page 30.

For information about other module sizes, please contact your local Roxtec supplier or e-mail: info@roxtec.com

Module	External dim. (mm) HxW (D=60 mm)	Weight (max)		Art. No
		(kg)	(lb)	
RM 10w120/0 BG B	10x120	0.12	0.256	109378
RM 20/0 BG B	20x20	0.04	0.088	103345
RM 30/0 BG B	30x30	0.08	0.181	103348
RM 40/0 BG B	40x40	0.15	0.320	103351
RM 60/0 BG B	60x60	0.34	0.754	103354
RM 10w120/0 BG	10x120	0.12	0.256	109376
RM 20/0 BG	20x20	0.04	0.088	102431
RM 30/0 BG	30x30	0.08	0.181	102432
RM 40/0 BG	40x40	0.15	0.320	102433
RM 60/0 BG	60x60	0.34	0.754	102434

Smart tip: Consider using an RM module rather than a solid module. A Roxtec RM module installed with a solid center core serves the same purpose as a traditional solid module, but it also provides spare capacity for future installations.

Roxtec RM ES B modules

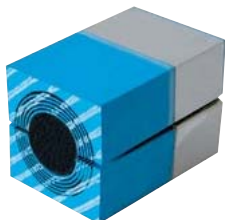

RM 40 ES B
– front view



RM 40 ES B
– back view

See information and measurements on page 30.

For information about other module sizes, please contact your local Roxtec supplier or e-mail: info@roxtec.com

Module	Number of cables/pipes	For cable/pipe diameter		External dim. (mm) HxW (D=60 mm)	Weight		Art. No
		\varnothing_a - \varnothing_b (mm)	\varnothing_a - \varnothing_b (in)		(kg)	(lb)	
WITH CORE							
RM 15 ES B	1	0+3.0-11.0	0+0.118-0.433	15x15	0.02	0.044	ERM1100151181
RM 15w40 ES B	3	0+3.5-10.5	0+0.138-0.413	15x40	0.05	0.110	ERM1115401181
RM 20 ES B	1	0+4.0-14.5	0+0.157-0.571	20x20	0.04	0.088	ERM1100201181
RM 20w40 ES B	2	0+3.5-16.5	0+0.138-0.650	20x40	0.07	0.154	ERM1120401181
RM 30 ES B	1	0+10.0-25.0	0+0.394-0.984	30x30	0.08	0.176	ERM1100301181
RM 40 ES B	1	0+21.5-34.5	0+0.846-1.358	40x40	0.14	0.309	ERM1100401181
RM 40 10-32 ES B	1	0+9.5-32.5	0+0.374-1.280	40x40	0.14	0.309	ERM1140101181
RM 60 ES B	1	0+28.0-54.0	0+1.102-2.126	60x60	0.33	0.728	ERM1100601181
RM 60 24-54 ES B	1	0+24.0-54.0	0+0.945-2.126	60x60	0.33	0.728	ERM1160201181
WITHOUT CORE							
RM 60 ES B woc	1	28.0-54.0	1.102-2.126	60x60	0.26	0.573	ERM1000601181
RM 80 ES B woc	1	48.0-71.0	1.890-2.795	80x80	0.46	1.014	110100
RM 90 ES B woc	1	48.0-71.0	1.890-2.795	90x90	0.56	1.235	ERM1000901181
RM 120 ES B woc	1	67.5-99.0	2.657-3.898	120x120	0.94	2.072	ERM1001201181

Roxtec RM ES modules

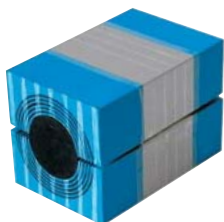

RM 40 ES

See information and measurements on page 30.

For information about other module sizes, please contact your local Roxtec supplier or e-mail: info@roxtec.com

Module	Number of cables/pipes	For cable/pipe diameter		External dim. (mm) HxW (D=60 mm)	Weight		Art. No
		\varnothing_a - \varnothing_b (mm)	\varnothing_a - \varnothing_b (in)		(kg)	(lb)	
WITH CORE							
RM 15 ES	1	0+3.0-11.0	0+0.118-0.433	15x15	0.02	0.044	ERM0100151181
RM 15w40 ES	3	0+3.5-10.5	0+0.138-0.413	15x40	0.05	0.110	ERM0115401181
RM 20 ES	1	0+4.0-14.5	0+0.157-0.571	20x20	0.04	0.088	ERM0100201181
RM 20w40 ES	2	0+3.5-16.5	0+0.138-0.650	20x40	0.07	0.154	ERM0120401181
RM 30 ES	1	0+10.0-25.0	0+0.394-0.984	30x30	0.08	0.176	ERM0100301181
RM 40 ES	1	0+21.5-34.5	0+0.846-1.358	40x40	0.14	0.309	ERM0100401181
RM 40 10-32 ES	1	0+9.5-32.5	0+0.374-1.280	40x40	0.14	0.309	ERM0140101181
RM 60 ES	1	0+28.0-54.0	0+1.102-2.126	60x60	0.33	0.728	ERM0100601181
RM 60 24-54 ES	1	0+24.0-54.0	0+0.945-2.126	60x60	0.33	0.728	ERM0160201181
WITHOUT CORE							
RM 60 ES woc	1	28.0-54.0	1.102-2.126	60x60	0.26	0.573	ERM0000601181
RM 80 ES woc	1	48.0-71.0	1.890-2.795	80x80	0.46	1.014	110097
RM 90 ES woc	1	48.0-71.0	1.890-2.795	90x90	0.56	1.235	ERM0000901181
RM 120 ES woc	1	67.5-99.0	2.657-3.898	120x120	0.94	2.072	ERM0001201181

Roxtec RM ES B, RM ES solid compensation modules

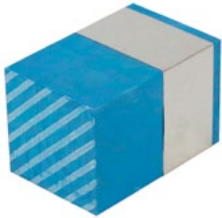

RM 40/0 ES B
– front view



RM 40/0 ES B
– back view



RM 40/0 ES

See information and measurements on page 30.

For information about other module sizes, please contact your local Roxtec supplier or e-mail: info@roxtec.com

Module	External dim. (mm) HxW (D=60 mm)	Weight (max)		Art. No
		(kg)	(lb)	
RM 5w120/0 ES B	5x120	0.06	0.126	ERM1351201181
RM 10/0 ES B	10x10	0.01	0.024	ERM1300101181
RM 10w120/0 ES B	10x120	0.12	0.254	ERM1310121181
RM 15/0 ES B	15x15	0.02	0.046	ERM1300151181
RM 20/0 ES B	20x20	0.04	0.088	ERM1300201181
RM 30/0 ES B	30x30	0.08	0.181	ERM1300301181
RM 40/0 ES B	40x40	0.15	0.320	ERM1300401181
RM 60/0 ES B	60x60	0.34	0.754	ERM1300601181
RM 5w120/0 ES	5x120	0.06	0.126	ERM0305121181
RM 10/0 ES	10x10	0.01	0.024	ERM0300101181
RM 10w120/0 ES	10x120	0.12	0.254	ERM0310121181
RM 15/0 ES	15x15	0.02	0.046	ERM0300151181
RM 20/0 ES	20x20	0.04	0.088	ERM0300201181
RM 30/0 ES	30x30	0.08	0.181	ERM0300301181
RM 40/0 ES	40x40	0.15	0.320	ERM0300401181
RM 60/0 ES	60x60	0.34	0.754	ERM0300601181

Smart tip: Consider using an RM module rather than a solid module. A Roxtec RM module installed with a solid centre core serves the same purpose as a traditional solid module, but it also provides spare capacity for future installations.

Roxtec RM PE B modules

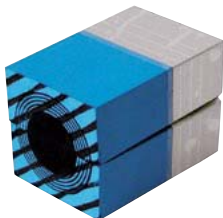

RM 40 PE B
– front view

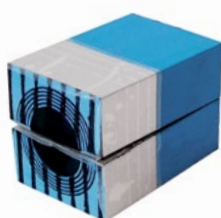

RM 40 PE B
– back view

See information and measurements on page 30.

For information about other module sizes, please contact your local Roxtec supplier or e-mail: info@roxtec.com

Module	Number of cables/pipes	For cable/pipe diameter		External dim. (mm) HxW (D=60 mm)	Weight		Art. No
		\varnothing_a - \varnothing_b (mm)	\varnothing_a - \varnothing_b (in)		(kg)	(lb)	
WITH CORE							
RM 15 PE B	1	0+3.0-11.0	0+0.118-0.433	15x15	0.02	0.044	PRM1100151181
RM 15w40 PE B	3	0+3.5-10.5	0+0.138-0.413	15x40	0.05	0.110	PRM1115401181
RM 20 PE B	1	0+4.0-14.5	0+0.157-0.571	20x20	0.04	0.088	PRM1100201181
RM 20w40 PE B	2	0+3.5-16.5	0+0.138-0.650	20x40	0.07	0.154	PRM1120401181
RM 30 PE B	1	0+10.0-25.0	0+0.394-0.984	30x30	0.08	0.176	PRM1100301181
RM 40 PE B	1	0+21.5-34.5	0+0.846-1.358	40x40	0.14	0.309	PRM1100401181
RM 40 10-32 PE B	1	0+9.5-32.5	0+0.374-1.280	40x40	0.14	0.309	PRM1140101181
RM 60 PE B	1	0+28.0-54.0	0+1.102-2.126	60x60	0.33	0.728	PRM1100601181
RM 60 24-54 PE B	1	0+24.0-54.0	0+0.945-2.126	60x60	0.33	0.728	PRM1160201181
WITHOUT CORE							
RM 60 PE B woc	1	28.0-54.0	1.102-2.126	60x60	0.26	0.573	PRM100601181
RM 80 PE B woc	1	48.0-71.0	1.890-2.795	80x80	0.44	0.97	110109
RM 90 PE B woc	1	48.0-71.0	1.890-2.795	90x90	0.56	1.235	PRM1000901181
RM 120 PE B woc	1	67.5-99.0	2.657-3.898	120x120	0.94	2.072	PRM1001201181

Roxtec RM PE modules



RM 40 PE

See information and measurements on page 30.

For information about other module sizes, please contact your local Roxtec supplier or e-mail: info@roxtec.com

Module	Number of cables/pipes	For cable/pipe diameter		External dim. (mm) HxW (D=60 mm)	Weight		Art. No
		\varnothing_a - \varnothing_b (mm)	\varnothing_a - \varnothing_b (in)		(kg)	(lb)	
WITH CORE							
RM 15 PE	1	0+3.0-11.0	0+0.118-0.433	15x15	0.02	0.044	PRM0100151181
RM 15w40 PE	3	0+3.5-10.5	0+0.138-0.413	15x40	0.05	0.110	PRM0115401181
RM 20 PE	1	0+4.0-14.5	0+0.157-0.571	20x20	0.04	0.088	PRM0100201181
RM 20w40 PE	2	0+3.5-16.5	0+0.138-0.650	20x40	0.07	0.154	PRM0120401181
RM 30 PE	1	0+10.0-25.0	0+0.394-0.984	30x30	0.08	0.176	PRM0100301181
RM 40 PE	1	0+21.5-34.5	0+0.846-1.358	40x40	0.14	0.309	PRM0100401181
RM 40 10-32 PE	1	0+9.5-32.5	0+0.374-1.280	40x40	0.14	0.309	PRM0140101181
RM 60 PE	1	0+28.0-54.0	0+1.102-2.126	60x60	0.33	0.728	PRM0100601181
RM 60 24-54 PE	1	0+24.0-54.0	0+0.945-2.126	60x60	0.33	0.728	PRM0160201181
WITHOUT CORE							
RM 60 PE woc	1	28.0-54.0	1.102-2.126	60x60	0.26	0.573	PRM0000601181
RM 80 PE woc	1	48.0-71.0	1.890-2.795	80x80	0.44	0.97	110108
RM 90 PE woc	1	48.0-71.0	1.890-2.795	90x90	0.56	1.235	PRM0000901181
RM 120 PE woc	1	67.5-99.0	2.657-3.898	120x120	0.94	2.072	PRM0001201181

Roxtec RM PE B, RM PE solid compensation modules

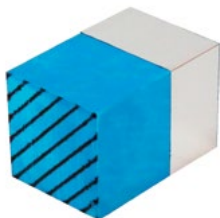

RM 40/0 PE B
– front view



RM 40/0 PE B
– back view



RM 40/0 PE

See information and measurements on page 30.

For information about other module sizes, please contact your local Roxtec supplier or e-mail: info@roxtec.com

Module	External dim. (mm) HxW (D=60 mm)	Weight (max)		Art. No
		(kg)	(lb)	
RM 5w120/0 PE B	5x120	0.06	0.126	PRM1351201181
RM 10/0 PE B	10x10	0.01	0.024	PRM1300101181
RM 10w120/0 PE B	10x120	0.12	0.254	PRM1310121181
RM 15/0 PE B	15x15	0.02	0.046	PRM1300151181
RM 20/0 PE B	20x20	0.04	0.088	PRM1300201181
RM 30/0 PE B	30x30	0.08	0.181	PRM1300301181
RM 40/0 PE B	40x40	0.15	0.320	PRM1300401181
RM 60/0 PE B	60x60	0.34	0.754	PRM1300601181
RM 5w120/0 PE	5x120	0.06	0.126	PRM0305121181
RM 10/0 PE	10x10	0.01	0.024	PRM0300101181
RM 10w120/0 PE	10x120	0.12	0.254	PRM0310121181
RM 15/0 PE	15x15	0.02	0.046	PRM0300151181
RM 20/0 PE	20x20	0.04	0.088	PRM0300201181
RM 30/0 PE	30x30	0.08	0.181	PRM0300301181
RM 40/0 PE	40x40	0.15	0.320	PRM0300401181
RM 60/0 PE	60x60	0.34	0.754	PRM0300601181

Smart tip: Consider using an RM module rather than a solid module. A Roxtec RM module installed with a solid centre core serves the same purpose as a traditional solid module, but it also provides spare capacity for future installations.

Roxtec CM BG B™ modules



CM 40 10-32 BG B
– front view



CM 20w40 BG B
– front view

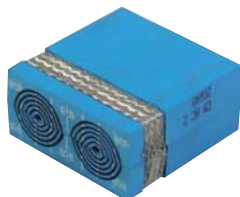

CM 20w40 BG B
– back view

See information and measurements on page 31.

Module	Number of cables/pipes	For cable/pipe diameter		External dim. (mm) HxW (D=40 mm)	Weight		Art. No
		\varnothing_a - \varnothing_b (mm)	\varnothing_a - \varnothing_b (in)		(kg)	(lb)	
CM 20w40 BG B	2	0+3.5-16.5	0+0.138-0.650	20x40	0.05	0.110	103375
CM 30w40 BG B	1	0+10-25	0+0.394-0.984	30x40	0.08	0.176	103379
CM 40 10-32 BG B	1	0+9.5-32.5	0+0.374-1.280	40x40	0.10	0.220	103381

Roxtec CM BG™ B solid compensation modules

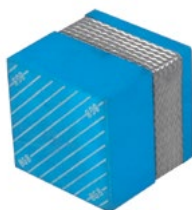

CM 40/0 BG B
– front view

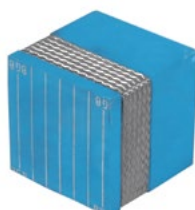

CM 40/0 BG B
– back view

See information and measurements on page 31.

Module	External dim. (mm) HxW (D=40 mm)	Weight (max)		Art. No
		(kg)	(lb)	
CM 10w40/0 BG B	10 x 40	0.02	0.044	103903
CM 40/0 BG B	40 x 40	0.08	0.176	103366

Roxtec CM ES modules



CM 20w40 ES
– front view



CM 20w40 ES
– back view

See information and measurements on page 31.

Module	Number of cables/pipes	For cable/pipe diameter		External dim. (mm) HxW (D=40 mm)	Weight		Art. No
		\varnothing_a - \varnothing_b (mm)	\varnothing_a - \varnothing_b (in)		(kg)	(lb)	
CM 15w40 ES	3	0+3.5-10.5	0+0.138-0.413	15x40	0.04	0.088	EC00115401181
CM 20 ES	1	0+4.0-14.5	0+0.157-0.571	20x20	0.03	0.066	EC00100201181
CM 20w40 ES	2	0+3.5-16.5	0+0.138-0.650	20x40	0.05	0.110	EC00120401181
CM 30w40 ES	1	0+10.0-25.0	0+0.394-0.984	30x40	0.08	0.176	EC00130401181
CM 40 10-32 ES	1	0+9.5-32.5	0+0.374-1.280	40x40	0.10	0.220	EC00140121181

Roxtec CM ES solid compensation modules



CM 10w40/0 ES
– front view



CM 10w40/0 ES
– back view

See information and measurements on page 31.

Module	External dim. (mm) HxW (D=40 mm)	Weight (max)		Art. No
		(kg)	(lb)	
CM 5w40/0 ES	5 x 40	0.01	0.022	EC00305401181
CM 10w40/0 ES	10 x 40	0.02	0.044	EC00310401181
CM 40/0 ES	40 x 40	0.10	0.220	5EC0000000005

Roxtec CM PE modules



CM 20w40 PE
– front view



CM 20w40 PE
– back view

See information and measurements on page 31.

Module	Number of cables/pipes	For cable/pipe diameter		External dim. (mm) HxW (D=40 mm)	Weight		Art. No
		\varnothing_a - \varnothing_b (mm)	\varnothing_a - \varnothing_b (in)		(kg)	(lb)	
CM 15w40 PE	3	0+3.5-10.5	0+0.138-0.413	15x40	0.04	0.088	PC00115401181
CM 20 PE	1	0+4.0-14.5	0+0.157-0.571	20x20	0.03	0.066	PC00100201181
CM 20w40 PE	2	0+3.5-16.5	0+0.138-0.650	20x40	0.05	0.110	PC00120401181
CM 30w40 PE	1	0+10.0-25.0	0+0.394-0.984	30x40	0.08	0.176	PC00130401181
CM 40 10-32 PE	1	0+9.5-32.5	0+0.374-1.280	40x40	0.10	0.220	PC00140101181

Roxtec CM PE solid compensation modules



CM 10w40/0 ES
– front view

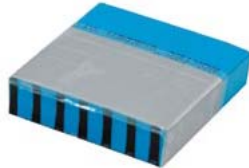

CM 10w40/0 ES
– back view

See information and measurements on page 31.

Module	External dim. (mm) HxW (D=40 mm)	Weight (max)		Art. No
		(kg)	(lb)	
CM 5w40/0 PE	5 x 40	0.01	0.022	PC00305401181
CM 10w40/0 PE	10 x 40	0.02	0.044	PC00310401181
CM 40/0 PE	40 x 40	0.10	0.220	PC00300401181



Roxtec Wedge EMC

The Roxtec Wedge EMC is used in frames with a rectangular packing space without built-in compression. Compresses and seals the installation of cables, pipes, modules and stayplates.

- For use with Group RM EMC frames and components

Roxtec BG™, PE system wedge kits/parts, galvanized/AISI 316



Wedge kit 120 galv



Wedge 120 galv



Wedge 60 galv

See information and measurements on page 34.

Wedge	External dimensions		Weight		Art. No
	W (mm)	W (in)	(kg)	(lb)	
Wedge kit 120 galv	120	4.724	1.5	3.307	AWK0001201018
Wedge 120 galv	120	4.724	0.8	1.764	ARW0001201018
Wedge 60 galv	60	2.362	0.4	0.882	ARW0000601018
Wedge kit 120 AISI 316	120	4.724	1.5	3.307	AWK0001201021
Wedge 120 AISI 316	120	4.724	0.8	1.764	ARW0001201021
Wedge 60 AISI 316	60	2.362	0.4	0.882	ARW0000601021

* The Wedge kit includes one Roxtec Wedge 120, five stayplates, one Wedge Clip, one lubricant and installation instructions.

Roxtec ES system wedge kits/parts, galvanized/AISI 316



Wedge kit 120 ES galv



Wedge 120 ES galv



Wedge 60 ES galv

See information and measurements on page 34.

Wedge	External dimensions		Weight		Art. No
	W (mm)	W (in)	(kg)	(lb)	
Wedge kit 120 ES galv	120	4.724	1.5	3.307	103400
Wedge 120 ES galv	120	4.724	0.8	1.764	ARW0000012391
Wedge 60 ES galv	60	2.362	0.4	0.882	103398
Wedge kit 120 ES AISI 316	120	4.724	1.5	3.307	103401
Wedge 120 ES AISI 316	120	4.724	0.8	1.764	103370
Wedge 60 ES AISI 316	60	2.362	0.4	0.882	103397

* The Wedge kit 120 ES includes one Roxtec Wedge 120 ES, five stayplates, one Wedge Clip, one lubricant and installation instructions.

Roxtec EMC frame selection guide

Suitable for EMC installations with BG, ES or PE modules.
Frames must be properly connected to earth.

	Rectangular frames					Enclosure frames				Sleeves for round frames/seals	
	S	SF	SK	SBTB	GHM	CF 8, CF 32 EMC	CF 8, CF 32 BG	ComSeal EMC	G	SLF R/RS	SL R/RS
Bonding and grounding	✓	✓	✓	✓	✓ 1	—	✓	—	✓ 3	—	—
Shielding	✓	✓ 3	✓	✓	✓ 2	✓	—	✓	✓ 3	✓ 2	✓
Conducted EMI	✓	✓	✓	✓	✓ 1	✓	✓	✓	✓ 3	✓ 2	✓

1. Comes without ground lug
2. Conductive gasket not included
3. If installed by welding



Ground lug

Recommended addition to frames used for bonding and grounding.
Frames with a ground lug with alternative flange dimensions available upon request.

Roxtec EMC marking tool



The marking tool is used for simple and quick guidance on where to remove the cable sheath and where to add check marks on the cables before assembly. This is to make sure that both the cable and its uncovered cable screen are fitted correctly into the module.

Tool	Art. No
EMC Marking Tool	IQR0002000000

Roxtec frames and seals for EMC applications

This is an overview showing Roxtec frames and seals suitable for EMC applications:



Roxtec S frame

See page 40.



Roxtec SK frame

See page 52.



Roxtec SBTB frame

See page 54.



Roxtec SF frame

See page 56.



Roxtec GHM frame

See page 61.



Roxtec G frame

See page 98.



Roxtec R EMC frame

See page 125.



Roxtec RS EMC seal

See page 127.



Roxtec ComSeal™ EMC

See page 129.



Roxtec CF 8 EMC frame

See page 131.



Roxtec CF 32 EMC frame

See page 131.

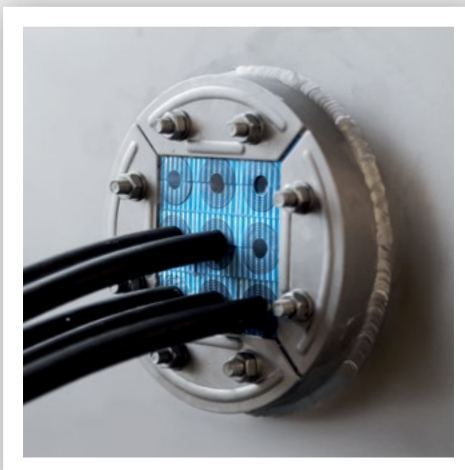

Roxtec R EMC frame

The Roxtec R EMC is a round expansion frame with a square packing space for cables, pipes and modules. Compression is integrated in the frame. Allows installation around existing cables and pipes.

- Compression by expansion
- For use with Roxtec RM ES and RM PE modules
- Sleeves are available

R EMC frame, galvanized mild steel fittings

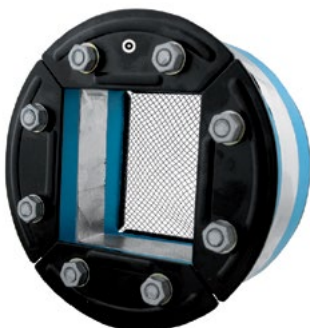

R 150 EMC galv

See information and measurements on page 65.

See parts needed for a complete solution on page 26.

See sleeves on page 66.

Installation instructions are available on www.roxtec.com

RATINGS

A class, H class, water and gas-tight

Frame	Packing space (mm)	For hole Ø		Weight		Art. No
		(mm)	(in)	(kg)	(lb)	
R 100 EMC galv	60 x 60	100 x 85	3.937 x 3.346	0.7	1.499	ER00A01001118
R 125 EMC galv	80 x 80	125 x 70	4.921 - 2.756	1,1	2.447	5R00000007751
R 127 EMC galv	80 x 80	127 x 70	5.000 x 2.756	1.1	2.447	ER00A01271118
R 150 EMC galv	90 x 90	150 x 70	5.906 x 2.756	1.6	3.638	ER00A01501118
R 200 EMC galv	120 x 120	200 x 70	7.874 x 2.756	2.6	5.732	ER00A02001118

R EMC frame, acid-proof stainless steel fittings

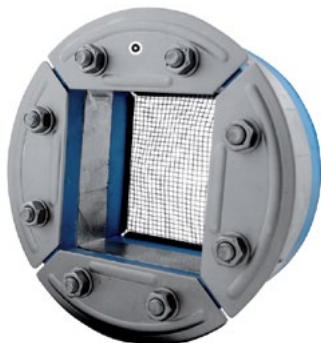

See information and measurements on page 65.

See parts needed for a complete solution on page 26.

See sleeves on page 66.

Installation instructions are available on www.roxtec.com

R 150 EMC AISI 316

RATINGS

A class, H class, water and gas-tight

Frame	Packing space (mm)	For hole Ø		Weight		Art. No
		(mm)	(in)	(kg)	(lb)	
R 70 EMC AISI 316	40 x 40	70 x 70	2.756 x 2.756	0.5	1.014	ER00A00701121
R 75 EMC AISI 316	40 x 40	75 x 70	2.953 x 2.756	0.5	1.102	ER00A00751121
R 100 EMC AISI 316	60 x 60	100 x 85	3.937 x 3.346	0.6	1.499	ER00A01001121
R 125 EMC AISI 316	80 x 80	125 x 70	4.921 x 2.756	1.1	2.447	5ER0000003976
R 127 EMC AISI 316	80 x 80	127 x 70	5.000 x 2.756	1.1	2.447	ER00A01271121
R 150 EMC AISI 316	90 x 90	150 x 70	5.906 x 2.756	1.6	3.638	ER00A01501121
R 200 EMC AISI 316	120 x 120	200 x 70	7.874 x 2.756	2.6	5.732	ER00A02001121

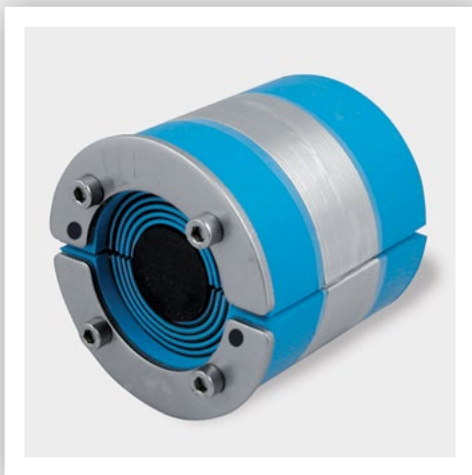

Roxtec RS EMC seals

Roxtec RS EMC seals are round entry seals consisting of two halves with an adaptable center with removable layers. Compression is integrated in the seal. Allows installation around an existing cable or pipe.

- Electromagnetic shielding
- Potential equalization
- For one cable or one pipe
- Sleeves are available

RS ES seal, acid-proof stainless steel fittings

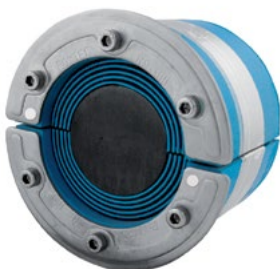

RS 100 ES AISI 316



RS 100 ES AISI 316 woc

See information and measurements on page 71.

See sleeves on page 73.

Installation instructions are available on www.roxtec.com

RATINGS

A class, H class, water and gas-tight

Seal	For cable/pipe Ø		External dimensions		Weight		Art. No
	(mm)	(in)	ØxD (mm)	ØxD (in)	(kg)	(lb)	
WITH CORE							
RS 25 ES AISI 316	0+3.6-12	0+0.142-0.472	25 x 40	0.984 x 1.575	0.04	0.093	ERS0100251121
RS 31 ES AISI 316	0+4-17	0+0.157-0.669	31 x 40	1.220 x 1.575	0.06	0.132	ERS0100311121
RS 43 ES AISI 316	0+4-23	0+0.157-0.906	43 x 78	1.693 x 3.071	0.2	0.529	ERS0100431121
RS 50 ES AISI 316	0+8-30	0+0.315-1.181	50 x 78	1.969 x 3.071	0.3	0.639	ERS0100501121
RS 68 ES AISI 316	0+26-48	0+1.024-1.890	68 x 78	2.677 x 3.071	0.5	1.102	ERS0100681121
RS 75 ES AISI 316	0+24-54	0+0.945-2.126	75 x 78	2.953 x 3.071	0.7	1.543	ERS0100751121
RS 100 ES AISI 316	0+48-70	0+1.890-2.756	100 x 83	3.937 x 3.268	1.0	2.205	ERS0101001121
RS 125 ES AISI 316	0+66-98	0+2.598-3.858	125 x 83	4.921 x 3.268	1.6	3.417	ERS0101251121

RS ES seal, acid-proof stainless steel fittings

Seal	For cable/pipe Ø		External dimensions		Weight		Art. No
	(mm)	(in)	ØxD (mm)	ØxD (in)	(kg)	(lb)	
WITHOUT CORE							
RS 100 ES AISI 316 woc	48-70	1.890-2.756	100 x 83	3.937 x 3.268	0.8	1.874	ERS0001001121
RS 125 ES AISI 316 woc	66-98	2.598-3.858	125 x 83	4.921 x 3.268	1.2	2.756	ERS0001251121
RS 150 ES AISI 316 woc	93-119	3.661-4.685	150 x 85	5.906 x 3.346	1.6	3.417	ERS0001501121

RS PE seal, acid-proof stainless steel fittings

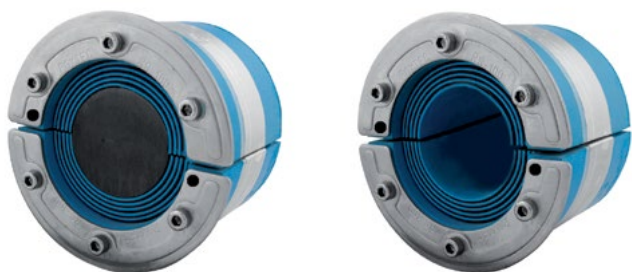

RS 100 PE AISI 316

RS 100 PE AISI 316 woc

See information and measurements on page 71.

See sleeves on page 73.

Installation instructions are available on www.roxtec.com

RATINGS

A class, H class, water and gas-tight

Seal	For cable/pipe Ø		External dimensions		Weight		Art. No
	(mm)	(in)	ØxD (mm)	ØxD (in)	(kg)	(lb)	
WITH CORE							
RS 25 PE AISI 316	0+3.6-12	0+0.142-0.472	25 x 40	0.984 x 1.575	0.04	0.093	PRS0100251121
RS 31 PE AISI 316	0+4-17	0+0.157-0.669	31 x 40	1.220 x 1.575	0.06	0.132	PRS0100311121
RS 43 PE AISI 316	0+4-23	0+0.157-0.906	43 x 78	1.693 x 3.071	0.2	0.529	PRS0100431121
RS 50 PE AISI 316	0+8-30	0+0.315-1.181	50 x 78	1.969 x 3.071	0.3	0.639	PRS0100501121
RS 68 PE AISI 316	0+26-48	0+1.024-1.890	68 x 78	2.677 x 3.071	0.5	1.102	PRS0100681121
RS 75 PE AISI 316	0+24-54	0+0.945-2.126	75 x 78	2.953 x 3.071	0.7	1.543	PRS0100751121
RS 100 PE AISI 316	0+48-70	0+1.890-2.756	100 x 83	3.937 x 3.268	1.0	2.205	PRS0101001121
RS 125 PE AISI 316	0+66-98	0+2.598-3.858	125 x 83	4.921 x 3.268	1.6	3.417	PRS0101251121
WITHOUT CORE							
RS 100 PE AISI 316 woc	48-70	1.890-2.756	100 x 83	3.937 x 3.268	0.8	1.874	PRS0001001121
RS 125 PE AISI 316 woc	66-98	2.598-3.858	125 x 83	4.921 x 3.268	1.2	2.756	PRS0001251121
RS 150 PE AISI 316 woc	93-119	3.661-4.685	150 x 85	5.906 x 3.346	1.6	3.417	PRS0001501121

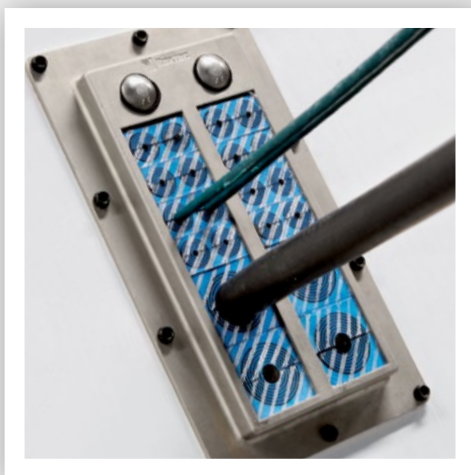

Roxtec ComSeal™ EMC

The Roxtec ComSeal EMC protects against EMI. The product family is designed for industrial and telecom applications such as converters, generators and cabinets. The frame is in nickel-plated aluminum and allows for pre-terminated cables.

- The frames are supplied as pre-defined kits
- Electromagnetic shielding
- Potential equalization

ComSeal™ EMC kits, nickel-plated aluminum, ES/PE system



ComSeal 10/4 ES

ComSeal 12/3 ES

ComSeal 15/3 ES

ComSeal 16/10 ES

ComSeal 30/6 ES

ComSeal 32/8 ES

See information and measurements on page 90.

Installation instructions are available on www.roxtec.com

See practical user guidelines on page 264.

Additional modules, depth 30 mm, can be purchased separately.

RATINGS

IP: 54

UL/NEMA: 12, 12K

Kit	Diameter range and number of cables/pipes Note: Module depth 30 mm			Weight		Art. No
	0+3.5-16.5 mm 0+0.138-0.650 in (CM 20w40 ES/PE 30)	0+9.5-32.5 mm 0+0.374-1.280 in (CM 40 10-32 ES/PE 30)	0+28-43 mm 0+1.102-1.693 in (CM 50 ES/PE 30)	(kg)	(lb)	
ComSeal 10/4 ES	2 cables/pipes	2 cables/pipes		0.52	1.14	CSE000000104
ComSeal 10/7 ES	6 cables/pipes	1 cable/pipe		0.52	1.14	CSE000000107
ComSeal 10/10 ES	10 cables/pipes			0.52	1.14	CSE0000001010
ComSeal 10/4 PE	2 cables/pipes	2 cables/pipes		0.52	1.14	CSP000000104

ComSeal™ EMC kits, nickel-plated aluminum, ES/PE system

Kit	Diameter range and number of cables/pipes Note: Module depth 30 mm			Weight		Art. No
	0+3.5-16.5 mm 0+0.138-0.650 in (CM 20w40 ES/PE 30)	0+9.5-32.5 mm 0+0.374-1.280 in (CM 40 10-32 ES/PE 30)	0+28-43 mm 0+1.102-1.693 in (CM 50 ES/PE 30)	(kg)	(lb)	
ComSeal 10/7 PE	6 cables/pipes	1 cable/pipe		0.52	1.14	CSP000000107
ComSeal 10/10 PE	10 cables/pipes			0.52	1.14	CSP0000001010
ComSeal 12/3 ES		3 cables/pipes		0.61	1.34	CSE0000001203
ComSeal 12/6 ES	4 cables/pipes	2 cables/pipes		0.61	1.34	CSE0000001206
ComSeal 12/9 ES	8 cables/pipes	1 cable/pipe		0.61	1.34	CSE0000001209
ComSeal 12/12 ES	12 cables/pipes			0.61	1.34	CSE0000001212
ComSeal 12/3 PE		3 cables/pipes		0.61	1.34	CSP0000001203
ComSeal 12/6 PE	4 cables/pipes	2 cables/pipes		0.61	1.34	CSP0000001206
ComSeal 12/9 PE	8 cables/pipes	1 cable/pipe		0.61	1.34	CSP0000001209
ComSeal 12/12 PE	12 cables/pipes			0.61	1.34	CSP0000001212
ComSeal 15/3 ES			3 cables/pipes	0.91	2.0	CSE0000001503
ComSeal 15/3 PE			3 cables/pipes	0.91	2.0	CSP0000001503
ComSeal 16/4 ES		4 cables/pipes		0.67	1.47	CSE000000164
ComSeal 16/7 ES	4 cables/pipes	3 cables/pipes		0.67	1.47	CSE000000164
ComSeal 16/10 ES	8 cables/pipes	2 cables/pipes		0.67	1.47	CSE000000167
ComSeal 16/16 ES	16 cables/pipes			0.67	1.47	CSE0000001610
ComSeal 16/4 PE		4 cables/pipes		0.67	1.47	CSE0000001616
ComSeal 16/7 PE	4 cables/pipes	3 cables/pipes		0.67	1.47	CSP000000164
ComSeal 16/10 PE	8 cables/pipes	2 cables/pipes		0.67	1.47	CSP000000167
ComSeal 16/16 PE	16 cables/pipes			0.67	1.47	CSP0000001610
ComSeal 30/6 ES			6 cables/pipes	1.40	3.09	CSE0000003006
ComSeal 30/6 PE			6 cables/pipes	1.40	3.09	CSP0000003006
ComSeal 32/8 ES		8 cables/pipes		1.26	2.78	CSE0000003208
ComSeal 32/14 ES	8 cables/pipes	6 cables/pipes		1.26	2.78	CSE0000003214
ComSeal 32/20 ES	16 cables/pipes	4 cables/pipes		1.26	2.78	CSE0000003220
ComSeal 32/32 ES	32 cables/pipes			1.26	2.78	CSE0000003232
ComSeal 32/8 PE		8 cables/pipes		1.26	2.78	CSP0000003208
ComSeal 32/14 PE	8 cables/pipes	6 cables/pipes		1.26	2.78	CSP0000003214
ComSeal 32/20 PE	16 cables/pipes	4 cables/pipes		1.26	2.78	CSP0000003220
ComSeal 32/32 PE	32 cables/pipes			1.26	2.78	CSP0000003232

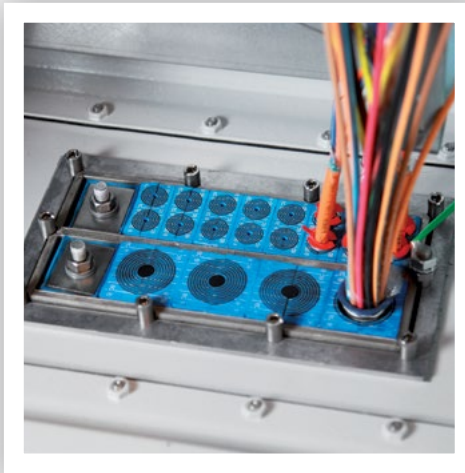

Rextec CF 8/CF 32 EMC/ BG frames/kits

The frames of cast aluminum with nickel-plating ensure good electrical conductivity. They can handle multiple pre-terminated cables/pipes in one opening.

- For use with CM BG B, CM ES or CM PE modules
- Electromagnetic shielding
- Potential equalization
- Bonding and grounding

CF 8 EMC/CF 32 EMC frames, ES/PE system

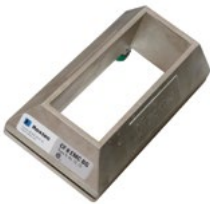

CF 8 EMC



CF 32 EMC

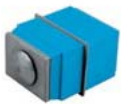

C Compression unit
ES AISI 316



C Compression unit
IP/PE AISI 316

Note: The compression unit is ordered separately.
See information and measurements on page 93.
See practical user guidelines on page 264.
Installation instructions are available on www.roxtec.com

RATINGS

IP: 66/67

UL/NEMA: 4, 4X, 12, 13

Frame	External dimensions		Weight		Art. No
	HxW (mm)	HxW (in)	(kg)	(lb)	
CF 8 EMC	140 x 75	5.512 x 2.952	0.6	1.213	ECF0000080035
CF 32 EMC	230 x 130	9.055 x 5.118	1.4	3.086	ECF0000320035
C Compression unit ES AISI 316	30 x 40	1.181 x 1.575	0.2	0.340	ECC0001001123
C Compression unit IP/PE AISI 316	30 x 40	1.181 x 1.575	0.2	0.340	CC00001001023

CF 8 BG™ B/CF 32 BG™ B kits/frames



CF 8/8 BG B



CF 32/8 BG B



CF 32/20 BG B



CF 32/32 BG B



CF 8 EMC BG



CF 32 EMC BG

Note: CF 8 EMC BG includes compression unit and ground lug.
CF 32 EMC BG includes compression units and ground lug.

See information and measurements on page 93.

See practical user guidelines on page 264.

Installation instructions are available on www.roxtec.com

RATINGS

IP: 66/67

UL/NEMA: 4, 4X, 12, 13

Kit	Diameter range and number of cables/pipes		Weight		Art. No
			(kg)	(lb)	
	0+3.5-16.5 mm/ 0+0.138-0.650 in (CM 20w40 BG B)	0+9.5-32.5 mm/ 0+0.374-1.280 in (CM 40 10-32 BG B)			
CF 8/8 BG B	8 cables/pipes		0.70	1.543	103464
CF 32/8 BG B		8 cables/pipes	2.00	4.409	103462
CF 32/20 BG B	16 cables/pipes	4 cables/pipes	2.00	4.409	103463
CF 32/32 BG B	32 cables/pipes		2.00	4.409	103461
CF 8 EMC BG			0.6	1.213	103465
CF 32 EMC BG			1.4	3.086	102826

Basic steps

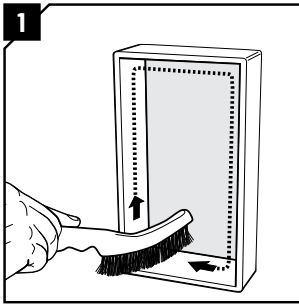

1 Clean the frame from dirt, paint etc. to secure good electrical conductivity.

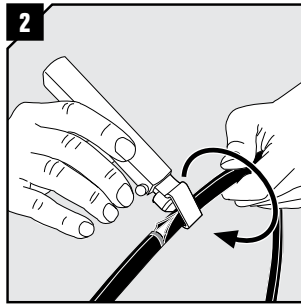

2 Cut and remove the outer sheath to expose the shield or armor of the cable.

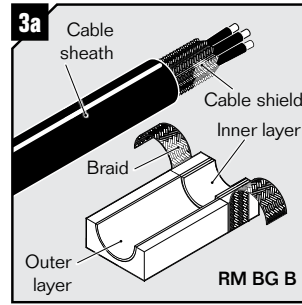

3a The following steps 3a–3f show the module preparation for the different types of EMC modules.

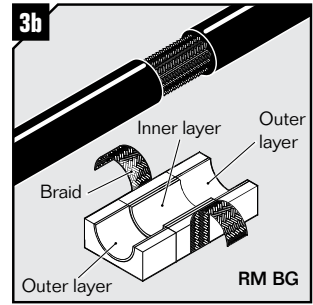

3b Fold back the tape or braid. Adapt the outer module layers to cable sheath and the inner ones to the cable shield.

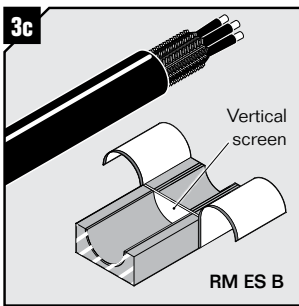

3c For ES modules, adapt vertical screen to cable shield.

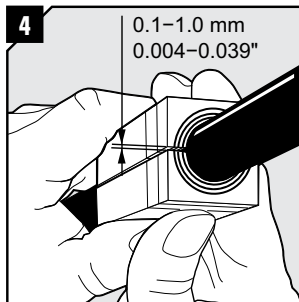
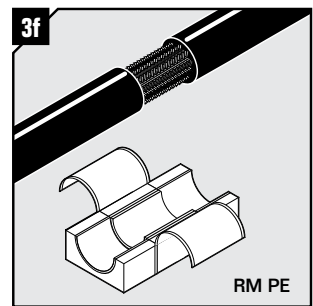
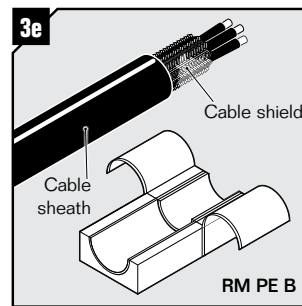
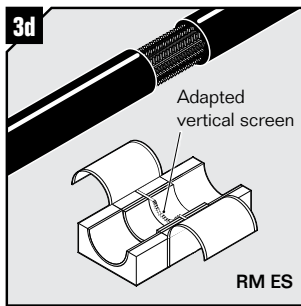

4 Achieve a 0.1–1.0 mm gap between the two halves when held against the cable/pipe. Fold the tape or braid tightly inside each module half.

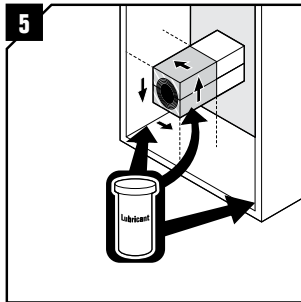

5 Lubricate the frame and modules.

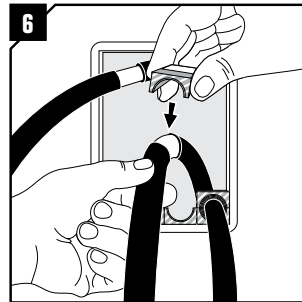

6 Place the cables in the module halves according to your packing plan.

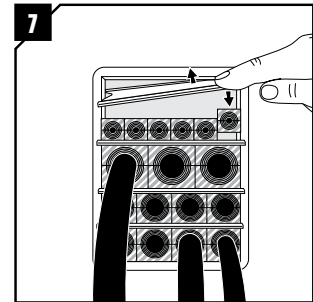

7 Insert a stayplate after every row of modules and fill the packing space.

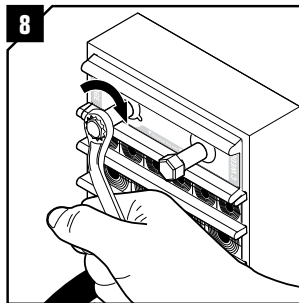

8 Lubricate and insert the wedge. Tighten the bolts alternately until full mechanical stop.

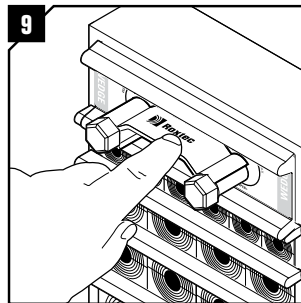

9 Attach the Wedge Clip to finalize the installation.

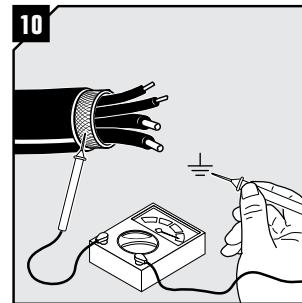

10 Verify earth continuity from each cable armor/screen to earth. Use a suitable instrument.

Installation tools

In order to further simplify installation, we provide tools for pre-compression of the modules in the frame. For more information about Roxtec tools, see page 214.

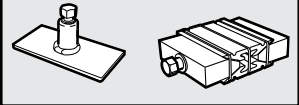

PIPE ENTRY SOLUTIONS

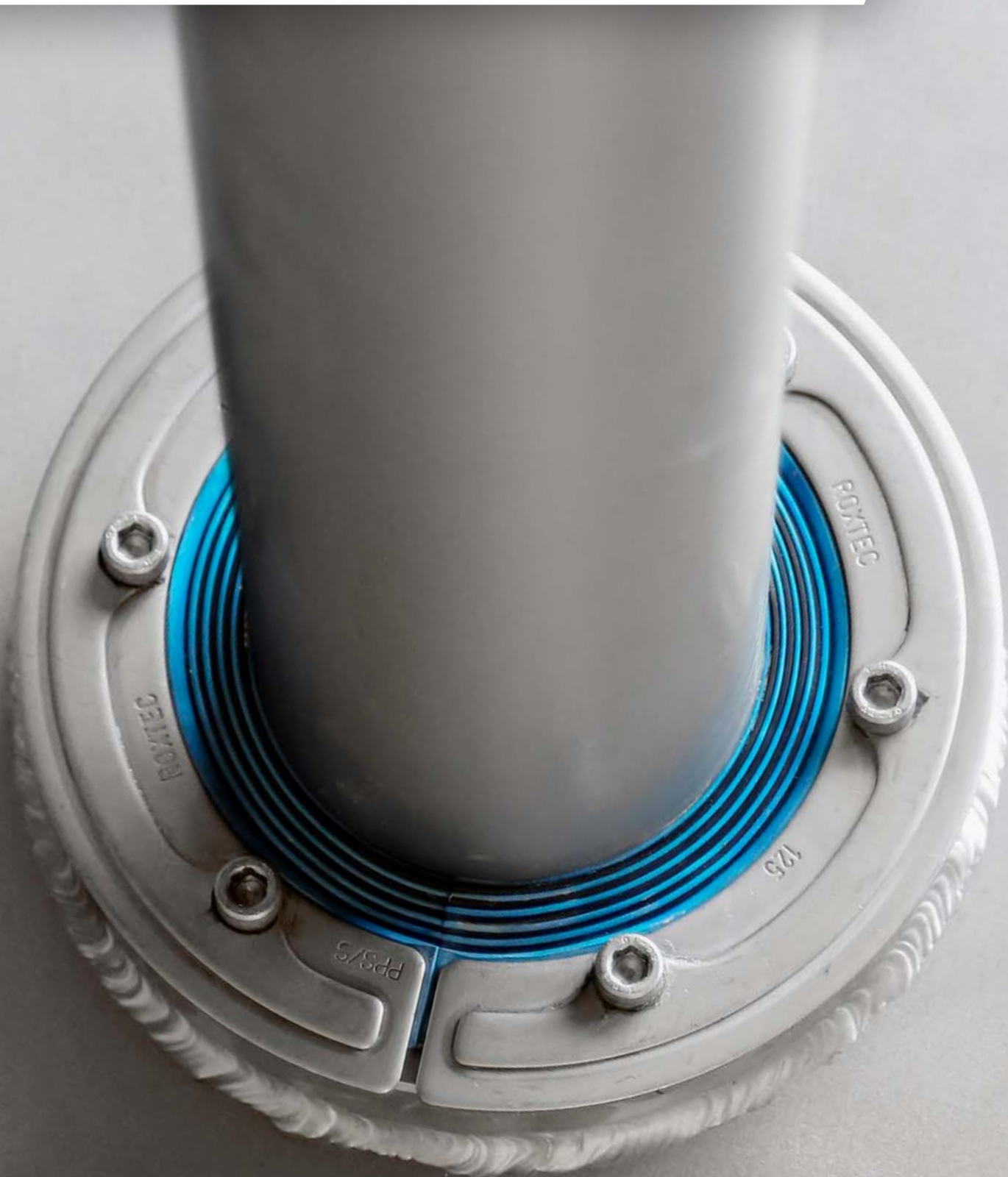

Covering a wide range of systems

Roxtec seals for pipe applications protect both life and assets against fire, water ingress and gas. They are designed to maintain the deck and bulkhead fire classifications after being penetrated by pipes.



A marine vessel is supported by a complex web of pipework which feeds various essential systems such as engine transfer systems, hydraulic fluid systems, sprinkler systems, hot and cold water and wastewater systems. The number of essential systems is matched by the variation in different types of pipe materials used to support them such as steel, copper, plastic and glass fiber.

Maintain the integrity

These variations in pipe material present multiple challenges when developing sealing solutions to protect pipe penetrations against hazards such as fire, water ingress and gas. To overcome



these difficulties, We have developed a wide range of pipe sealing solutions that offer protection against these hazards and maintain the integrity of the marine rated division.

Single or multiple pipes

Roxtec is also able to provide solutions that can be installed from only one side of the deck or bulkhead to increase flexibility within the installation process.

With a portfolio of certified pipe sealing solutions ranging from single to multiple penetrations and from 3.6 mm to 580 mm in diameter, we have the ability to meet all your pipe sealing needs.



Tested and certified

The sealing solutions offered by Roxtec provide protection to the following standards and ratings as defined by IMO and comply with the various testing programmes of each class society:

Fire rating: A class, B class, H class and jet-fire ratings

Water pressure: up to 6 bar

Gas-pressure: up to 2.5 bar

(All protection ratings depending on specific class society)

In addition to the standard Roxtec solutions, customized solutions can be designed and supplied which offer protection in areas that have higher demand requirements.

Safety and simplicity

The Roxtec pipe sealing solutions are designed to satisfy the various needs and requirements of

the marine segment. It is recognized that the demands in relation to fire integrity and water pressure requirements are different depending upon the location of the installation within the marine vessel.

Therefore, the Roxtec approach to its product range is to develop solutions that fit the relevant requirements for each of these areas in order to provide a safe and secure penetration seal that is both quick and easy to install. For this reason, the Roxtec product range includes firestop solutions, watertight and firestop solutions as well as solutions suitable for use either above or below the waterline.

Developed for specific needs

In addition to these operating criteria, We have developed our solution to maintain a watertight seal after a fire has occurred. It is to be used when the requirements make this necessary due

to the use of heat sensitive materials passing through watertight bulkheads. To reduce the need for welding during the installation process, Roxtec has also developed pipe sealing products that are non-welding solutions. Roxtec pipe sealing solutions can be used in steel decks and bulkheads as well as in aluminum structures where galvanic corrosion and other installation issues have been resolved. Further Roxtec solutions are also available for use in some A and B rated sandwich panel structures.

Metal pipe solutions

Roxtec provides first class sealing solutions for single and multiple metal pipes when passing through in decks and bulkheads. Ship owners and shipbuilders appreciate the excellent fire-stopping and watertight features of our systems to ensure high degrees of security and to maintain a safe working environment.

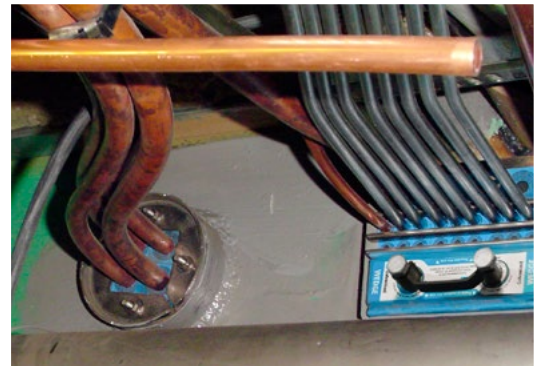

Roxtec transits for metal pipes are available in a wide range of types and sizes for various environments and use. We supply modular-based transits for both multiple pipe penetrations and single pipe penetrations. There are frames for round and rectangular openings as well as frames specifically designed to maintain the structural integrity of certain openings when located in high demand areas.

- Water pipes
- Wastewater pipes
- Hydraulic pipes
- Pneumatic pipes
- Transfer and distribution systems
- Sprinkler systems
- Restaurant and beverage pipes



Roxtec RS seal

The Roxtec RS seal is a circular solution which protects single metal pipe as well as glass fiber pipe penetrations. It consists of two halves and an adaptable center with Multidiameter™ (removable layers for adaptability to pipes of different sizes).

- Tightness obtained by expansion within the seal
- Single pipe penetration
- Sleeves are available
- Single side installation
- Certified fire, water and gas protection

RS seal, with core, acid-proof stainless steel fittings



See sleeves on page 142.
 See installation instructions on page 233.
 See practical user guidelines on page 264.

RATINGS Fire: A class, H class Water pressure: 4 bar Gas pressure: 2.5 bar

Seal	For pipe Ø		For hole Ø		Weight		Art. No
	(mm)	(in)	(mm)	(in)	(kg)	(lb)	
RS 25 AISI 316	0+3.6-12	0+0.142-0.472	25-26	0.984 - 1.024	0.04	0.093	RS00100251023
RS 31 AISI 316	0+4-17	0+0.157-0.669	31-32	1.221 - 1.260	0.06	0.132	RS00100311023
RS 43 AISI 316	0+4-23	0+0.157-0.906	43-45	1.693 - 1.772	0.2	0.529	RS00100431023
RS 50 AISI 316	0+8-30	0+0.315-1.181	50-52	1.967 - 2.047	0.3	0.639	RS00100501023

RS seal, with core, acid-proof stainless steel fittings

Seal	For pipe Ø		For hole Ø		Weight		Art. No
	(mm)	(in)	(mm)	(in)	(kg)	(lb)	
RS 68 AISI 316	0+26-48	0+1.024-1.890	68-70	2.677 - 2.756	0.5	1.102	RS00100681023
RS 75 AISI 316	0+24-54	0+0.945-2.126	75-77	2.953 - 3.031	0.7	1.543	RS00100751023
RS 100 AISI 316	0+48-70	0+1.890-2.756	100-102	3.937 - 4.016	1.0	2.205	RS00101001023
RS 125 AISI 316	0+66-98	0+2.598-3.858	125-127	4.921 - 5.000	1.6	3.417	RS00101251023

RS seal, without core, acid-proof stainless steel fittings

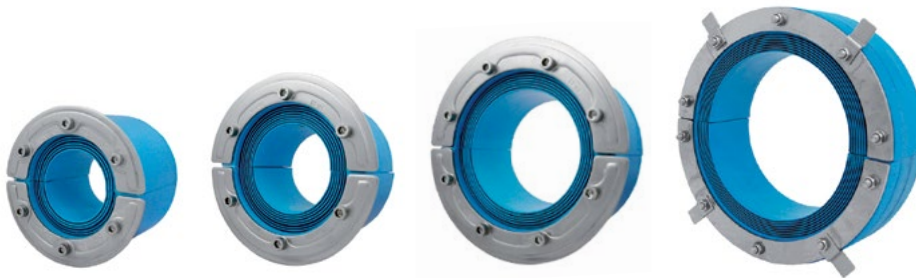

RS 100 AISI 316 woc

RS 125 AISI 316 woc

RS 150 AISI 316 woc

RS 225-644 AISI 316 woc

See sleeves on page 142.
See installation instructions on page 233.
See practical user guidelines on page 264.

RATINGS

Fire: A class, H class

Water pressure: 4 bar

Gas pressure: 2.5 bar

Seal	For pipe Ø		For hole Ø		Weight		Art. No
	(mm)	(in)	(mm)	(in)	(kg)	(lb)	
RS 100 AISI 316 woc	48-70	1.890-2.756	100-102	3.937-4.016	0.8	1.874	RS00001001023
RS 125 AISI 316 woc	66-98	2.598-3.858	125-127	4.921-5.000	1.2	2.756	RS00001251023
RS 150 AISI 316 woc	93-119	3.661-4.685	150-152	5.906-5.984	1.6	3.417	RS00001501023
RS 175 AISI 316 woc	119-145	4.685-5.709	175-177	6.890-6.969	2.2	4.189	RS00175750021
RS 200 AISI 316 woc	138-170	5.433-6.693	200-203	7.874-7.992	2.8	5.732	RS00200750021
RS 225 AISI 316 woc	151-181	5.945-7.126	225-228	8.858-8.976	3.1	6.834	RS00002250021
RS 250 AISI 316 woc	176-206	6.913-8.110	250-253	9.843-9.961	3.3	7.275	RS00002500021
RS 300 AISI 316 woc	206-236	8.094-9.291	300-303	11.811-11.929	5.7	12.566	RS00003000021
RS 350 AISI 316 woc	244-286	9.614-11.259	350-353	13.780-13.898	7.3	16.094	RS00003500021
RS 400 AISI 316 woc	294-336	11.583-13.228	400-403	15.748-15.886	8.9	19.621	RS00004000021
RS 450 AISI 316 woc	344-386	13.551-15.197	450-453	17.717-17.835	10.7	23.589	RS00004500021
RS 500 AISI 316 woc	394-436	15.519-17.165	500-503	19.685-19.803	13.0	28.660	RS00005000021
RS 550 AISI 316 woc	444-486	17.488-19.134	550-553	21.654-21.772	14.4	31.746	RS00005500021
RS 600 AISI 316 woc	494-536	19.457-21.102	600-603	23.622-23.740	15.7	34.612	RS00006000021
RS 644 AISI 316 woc	538-580	21.189-22.835	644-647	25.354-25.472	17.0	37.478	RS00006440021

RS seal, technical information

RS 25 / RS 31 / RS 43 / RS 50 / RS 68

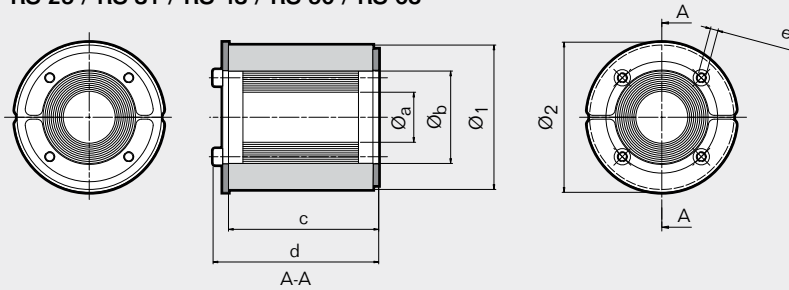

Pos	RS 25		RS 31		RS 43		RS 50		RS 68		RS 75		
	(mm)	(in)	(mm)	(in)	(mm)	(in)	(mm)	(in)	(mm)	(in)	(mm)	(in)	
Ø _a	3.6	0.142	4	0.157	4	0.157	8	0.315	26	1.024	24	0.945	
Ø _b	12	0.472	17	0.669	23	0.906	30	1.181	48	1.890	54	2.126	
Ø ₁	25	0.984	31	1.220	43	1.693	50	1.969	68	2.677	75	2.953	
Ø ₂	32	1.260	37	1.457	53	2.087	60	2.362	78	3.071	85	3.346	
c	39	1.535	40	1.575	78	3.071	78	3.071	78	3.071	78	3.071	
d	43	1.693	44	1.732	85	3.346	85	3.346	85	3.346	85	3.346	
e	*	*	*	*	**	**	**	**	**	**	**	***	***

* SW2.5 mm (4x) / SW0.098" (4x) ** SW4 mm (4x) / SW0.157" (4x) *** SW4 mm (6x) / SW0.157" (6x)

RS 75 / RS 100, RS 100 woc / RS 125, RS 125 woc

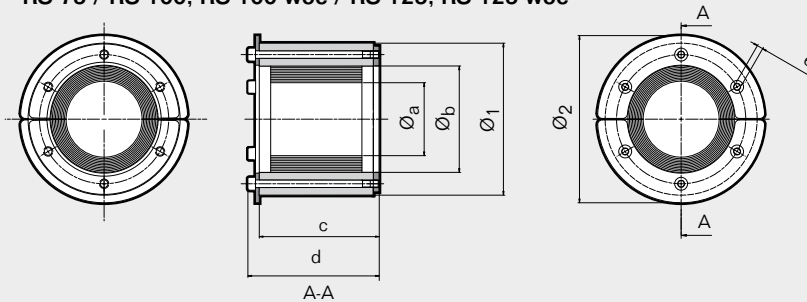

Pos	RS 100 (woc)		RS 125 (woc)	
	(mm)	(in)	(mm)	(in)
Ø _a	48	1.890	66	2.598
Ø _b	70	2.756	98	3.858
Ø ₁	100	3.937	125	4.921
Ø ₂	110	4.331	145	5.709
c	78	3.071	78	3.071
d	87	3.425	87	3.425
e	***	***	****	****

*** SW4 mm (6x) / SW0.157" (6x)
**** SW5 mm (6x) / SW0.197" (6x)

RS 150 woc

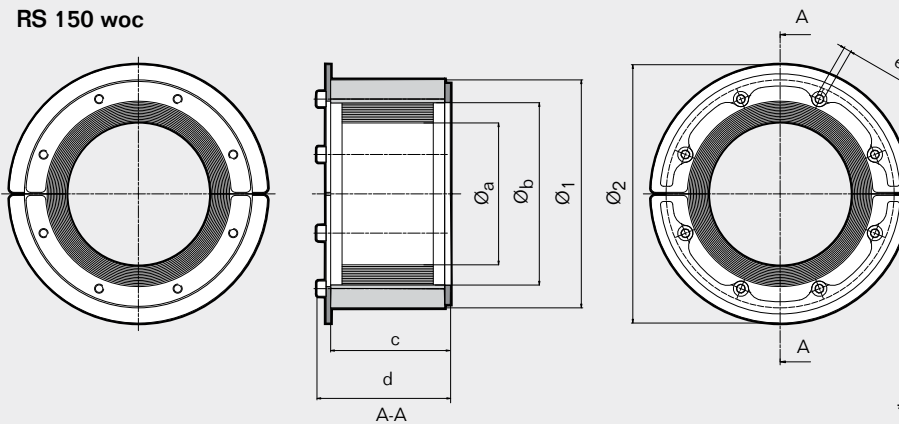

Pos	RS 150 woc	
	(mm)	(in)
Ø _a	93	3.661
Ø _b	119	4.685
Ø ₁	150	5.906
Ø ₂	170	6.693
c	79	3.110
d	88	3.465
e	*****	*****

***** SW5 mm (8x) / SW0.197" (8x)

Note: All dimensions are nominal values

RS seal, technical information

RS 175 woc / RS 200 woc

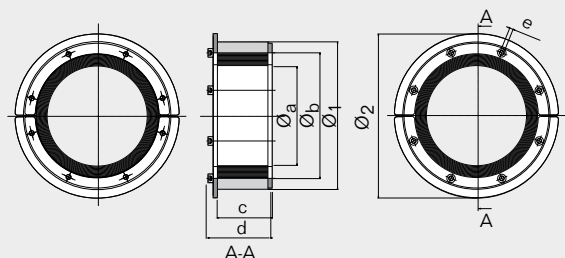

Pos	RS 175 (woc)		RS 200 (woc)	
	(mm)	(in)	(mm)	(in)
Ø _a	119	4.685	138	5.433
Ø _b	147	5.787	170	6.693
Ø ₁	175	6.890	200	7.874
Ø ₂	195	7.677	220	8.661
c	80	3.150	80	3.150
d	90	3.543	90	3.543
e	*	*	*	*

RS 225 woc / RS 250 woc

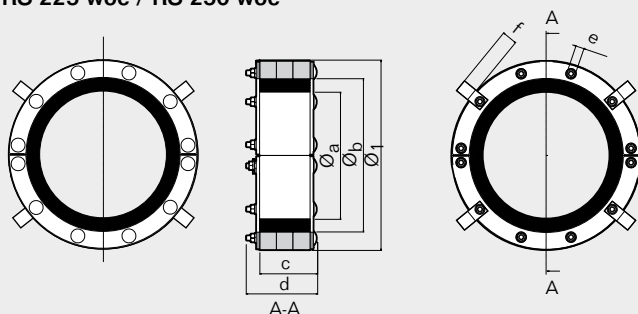

* SW 5 mm (8x) / SW 0.197" (8x)

Pos	RS 225 (woc)		RS 250 (woc)	
	(mm)	(in)	(mm)	(in)
Ø _a	151	5.945	176	6.913
Ø _b	181	7.126	206	8.110
Ø ₁	225	8.858	250	9.843
c	68	2.672	69	2.696
d	84	3.302	85	3.326
f	19	0.743	19	0.743
e	**	**	**	**

RS 300 woc / RS 350 woc / RS 400 woc / RS 450 woc / RS 500 woc / RS 550 woc / RS 600 woc / RS 644 woc

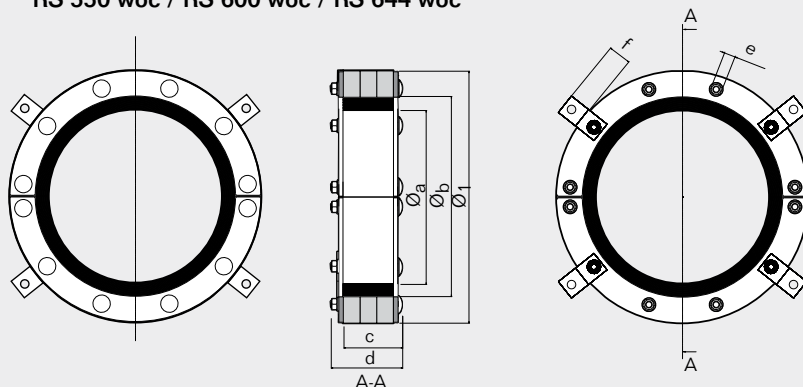

** SW 10 mm (10x) / SW 0.394" (10x)

Pos	RS 300 (woc)		RS 350 (woc)		RS 400 (woc)		RS 450 (woc)		RS 500 (woc)		RS 550 (woc)		RS 600 (woc)		RS 644 (woc)	
	(mm)	(in)	(mm)	(in)	(mm)	(in)	(mm)	(in)	(mm)	(in)	(mm)	(in)	(mm)	(in)	(mm)	(in)
c	71	2.775	71	2.775	71	2.775	71	2.775	74	2.889	74	2.889	74	2.889	74	2.889
d	85	3.342	85	3.342	86	3.357	96	3.755	96	3.755	96	3.755	96	3.755	96	3.755
Ø _a	206	8.094	244	9.614	294	11.583	344	13.551	394	15.519	444	17.488	494	19.457	538	21.189
Ø _b	236	9.291	286	11.259	336	13.228	386	15.197	436	17.165	486	19.134	536	21.102	580	22.835
Ø ₁	300	11.811	350	13.779	400	15.748	450	17.717	500	19.685	550	21.654	600	23.622	644	25.354
f	28	1.102	28	1.102	28	1.102	28	1.102	28	1.102	28	1.102	28	1.102	28	1.102
e	***	***	***	***	***	***	****	****	****	****	****	****	****	****	****	****

*** SW 13 mm (10x) / SW 0.512" (10x) **** SW 17 mm (10x) / SW 0.669" (10x)

Note: All dimensions are nominal values

Sleeves without flange, for RS seal



SLRS primed mild steel



SLRS acid-proof stainless steel



SLRS aluminum

See practical user guidelines on page 264.

Primed mild steel

Sleeve	Ø (mm)	External dimensions		Internal Ø		Weight		Art. No	
		Ø (in)	L (mm)	L (in)	(mm)	(in)	(kg)		(lb)
SLRS 25 primed	34	1.339	35	1.378	25.5	1.004	0.11	0.24	ASL1000250012
SLRS 31 primed	40	1.575	35	1.378	31.5	1.240	0.14	0.30	ASL1000310012
SLRS 43 primed	52	2.047	65	2.559	44	1.732	0.31	0.68	ASL1000430012
SLRS 50 primed	63	2.480	65	2.559	51	2.008	0.54	1.19	ASL1000500012
SLRS 68 primed	83	3.268	65	2.559	69.5	2.736	0.81	1.79	ASL1000680012
SLRS 75 primed	89	3.504	65	2.559	76.5	3.012	0.83	1.83	ASL1000750012
SLRS 100 primed	114	4.488	65	2.559	101	3.976	1.10	2.43	ASL1001000012
SLRS 125 primed	140	5.512	65	2.559	126	4.961	1.50	3.31	ASL1001250012
SLRS 150 primed	164	6.457	65	2.559	151	5.945	1.63	3.58	ASL1001500012
SLRS 175 primed	189	7.441	65	2.559	176	6.929	1.60	3.53	ASLR100017512
SLRS 200 primed	214	8.425	65	2.559	201	7.913	1.80	3.97	ASLR100020012
SLRS 225 primed	239	9.409	55	2.165	227	8.937	1.90	4.19	ASL1002250012
SLRS 250 primed	264	10.394	55	2.165	252	9.921	2.10	4.63	ASL1002500012
SLRS 300 primed	314	12.362	55	2.165	302	11.890	2.50	5.51	ASL1003000012
SLRS 350 primed	364	14.331	55	2.165	352	13.858	2.90	6.39	ASL1003500012
SLRS 400 primed	414	16.299	55	2.165	402	15.827	3.30	7.28	ASL1004000012
SLRS 450 primed	464	18.268	55	2.165	452	17.795	3.70	8.16	ASL1004500012
SLRS 500 primed	514	20.236	55	2.165	502	19.764	4.10	9.04	ASL1005000012
SLRS 550 primed	564	22.205	55	2.165	552	21.732	4.50	9.92	ASL1005500012
SLRS 600 primed	614	24.173	55	2.165	602	23.701	4.90	10.80	ASL1006000012
SLRS 644 primed	658	25.905	55	2.165	646	25.433	5.30	11.68	ASL1006440012

Sleeves without flange, for RS seal

Acid-proof stainless steel

Sleeve	External dimensions				Internal Ø		Weight		Art. No
	Ø (mm)	Ø (in)	L (mm)	L (in)	(mm)	(in)	(kg)	(lb)	
SLRS 25 AISI 316	34	1.339	35	1.378	25.5	1.004	0.11	0.24	ASL1000250021
SLRS 31 AISI 316	40	1.575	35	1.378	31.5	1.240	0.14	0.30	ASL1000310021
SLRS 43 AISI 316	52	2.047	65	2.559	44	1.732	0.31	0.67	ASL1000430021
SLRS 50 AISI 316	63	2.480	65	2.559	51	2.008	0.54	1.18	ASL1000500021
SLRS 68 AISI 316	83	3.268	65	2.559	69.5	2.736	0.83	1.83	ASL1000680021
SLRS 75 AISI 316	89	3.504	65	2.559	76.5	3.012	0.83	1.83	ASL1000750021
SLRS 100 AISI 316	114	4.488	65	2.559	101	3.976	1.13	2.49	ASL1001000021
SLRS 125 AISI 316	140	5.512	65	2.559	126	4.961	1.53	3.37	ASL1001250021
SLRS 150 AISI 316	164	6.457	65	2.559	151	5.945	1.63	3.59	ASL1001500021
SLRS 175 AISI 316	189	7.441	65	2.559	176	6.929	1.60	3.53	ASLR101750021
SLRS 200 AISI 316	214	8.425	65	2.559	201	7.913	1.85	4.07	ASLR100020021
SLRS 225 AISI 316	239	9.409	55	2.165	227	8.937	2.20	4.85	5ASL000007919
SLRS 250 AISI 316	264	10.394	55	2.165	252	9.921	2.10	4.63	5ASL000008504
SLRS 300 AISI 316	314	12.362	55	2.165	302	11.890	3.00	6.61	ASL1003000021

Aluminum

Sleeve	External dimensions				Internal Ø		Weight		Art. No
	Ø (mm)	Ø (in)	L (mm)	L (in)	(mm)	(in)	(kg)	(lb)	
SLRS 25 Alu	34	1.339	35	1.378	25.5	1.004	0.05	0.11	5ASL000004450
SLRS 31 Alu	40	1.575	35	1.378	31.5	1.240	0.03	0.07	5ASL000003374
SLRS 43 Alu	52	2.047	65	2.559	44	1.732	0.10	0.22	5ASL000006302
SLRS 50 Alu	63	2.480	65	2.559	51	2.008	0.09	0.20	5ASL000000663
SLRS 68 Alu	83	3.268	65	2.559	69.5	2.736	0.12	0.26	5ASL000000516
SLRS 75 Alu	89	3.504	65	2.559	76.5	3.012	0.27	0.60	5ASL000000517
SLRS 100 Alu	114	4.488	65	2.559	101	3.976	0.38	0.84	5ASL000001259
SLRS 125 Alu	140	5.512	65	2.559	126	4.961	0.51	1.12	5ASL000000421
SLRS 150 Alu	164	6.457	65	2.559	151	5.945	0.53	1.17	5ASL000000191

Sleeves with flange, for RS seal



SLFRS primed mild steel



SLFRS galvanized mild steel



SLFRS aluminum

See practical user guidelines on page 264.

Primed mild steel

Sleeve	External flange Ø		External dimensions				Internal Ø		Weight		Art. No
	(mm)	(in)	Ø (mm)	Ø (in)	L (mm)	L (in)	(mm)	(in)	(kg)	(lb)	
SLFRS 25 primed	96	3.780	34	1.339	35	1.378	25.5	1.004	0.26	0.58	ASF1000250012
SLFRS 31 primed	102	4.016	40	1.575	35	1.378	31.5	1.240	0.30	0.65	ASF1000310012
SLFRS 43 primed	110	4.331	52	2.047	65	2.559	44	1.732	0.50	1.10	ASF1000430012
SLFRS 50 primed	140	5.512	63	2.480	65	2.559	51	2.008	0.93	2.05	ASF1000500012
SLFRS 68 primed	155	6.102	83	3.268	65	2.559	69.5	2.736	1.23	2.72	ASF1000680012
SLFRS 75 primed	165	6.496	89	3.504	65	2.559	76.5	3.012	1.33	2.93	ASF1000750012
SLFRS 100 primed	195	7.677	114	4.488	65	2.559	101	3.976	1.76	3.87	ASF1001000012
SLFRS 125 primed	213	8.386	140	5.512	65	2.559	126	4.961	2.07	4.56	ASF1001250012
SLFRS 150 primed	236	9.291	164	6.457	65	2.559	151	5.945	2.34	5.16	ASF1001500012
SLFRS 175 primed	255	10.039	189	7.441	65	2.559	176	6.929	2.30	5.07	ASFR101750012
SLFRS 200 primed	290	11.417	214	8.425	65	2.559	201	7.913	2.78	6.13	ASFR100020012
SLFRS 225 primed	320	12.598	239	9.409	55	2.165	227	8.937	3.35	7.39	5ASF000005709
SLFRS 250 primed	345	13.583	264	10.394	55	2.165	252	9.921	3.70	8.16	ASF1002500012
SLFRS 300 primed	395	15.551	314	12.362	55	2.165	302	11.890	4.40	9.70	ASF1003000012
SLFRS 350 primed	445	17.520	364	14.331	55	2.165	352	13.858	5.00	11.02	ASF1003500012
SLFRS 400 primed	495	19.488	414	16.299	55	2.165	402	15.827	5.70	12.57	ASF1004000012
SLFRS 450 primed	544	21.417	464	18.268	55	2.165	452	17.795	6.40	14.11	ASF1004500012
SLFRS 500 primed	595	23.425	514	20.236	55	2.165	502	19.764	7.60	16.76	ASF1005000012
SLFRS 550 primed	645	25.394	564	22.205	55	2.165	552	21.732	8.40	18.52	ASF1005500012
SLFRS 600 primed	695	27.362	614	24.173	55	2.165	602	23.701	9.10	20.06	ASF1006000012
SLFRS 644 primed	739	29.094	658	25.905	55	2.165	646	25.433	9.70	21.38	ASF1006440012

Sleeves with flange, for RS seal

Galvanized mild steel

Sleeve	External flange Ø		External dimensions				Internal Ø		Weight		Art. No
	(mm)	(in)	Ø (mm)	Ø (in)	L (mm)	L (in)	(mm)	(in)	(kg)	(lb)	
SLFRS 25 galv	96	3.780	34	1.339	35	1.378	25.5	1.004	0.26	0.58	ASF1000250015
SLFRS 31 galv	102	4.016	40	1.575	35	1.378	31.5	1.240	0.31	0.68	ASF1000310015
SLFRS 43 galv	110	4.331	52	2.047	65	2.559	44	1.732	0.50	1.10	ASF1000430015
SLFRS 50 galv	140	5.512	63	2.480	65	2.559	51	2.008	0.96	2.11	ASF1000500015
SLFRS 68 galv	155	6.102	83	3.268	65	2.559	69.5	2.736	1.26	2.78	ASF1000680015
SLFRS 75 galv	165	6.496	89	3.504	65	2.559	76.5	3.012	1.35	2.97	ASF1000750015
SLFRS 100 galv	195	7.677	114	4.488	65	2.559	101	3.976	1.79	3.95	ASF1001000015
SLFRS 125 galv	213	8.386	140	5.512	65	2.559	126	4.961	2.13	4.70	ASF1001250015
SLFRS 150 galv	236	9.291	164	6.457	65	2.559	151	5.945	2.41	5.31	ASF1001500015

Aluminum

Sleeve	External flange Ø		External dimensions				Internal Ø		Weight		Art. No
	(mm)	(in)	Ø (mm)	Ø (in)	L (mm)	L (in)	(mm)	(in)	(kg)	(lb)	
SLFRS 25 Alu	96	3.780	96	3.780	35	1.378	25.5	1.004	0.03	0.07	5ASF000008715
SLFRS 31 Alu	102	4.016	102	4.016	35	1.378	31.5	1.240	0.55	1.21	5ASF000002399
SLFRS 43 Alu	110	4.331	110	4.331	65	2.559	44	1.732	0.18	0.40	5ASF000002197
SLFRS 50 Alu	140	5.512	140	5.512	65	2.559	51	2.008	0.31	0.68	5ASF000002198
SLFRS 68 Alu	155	6.102	155	6.102	65	2.559	69.5	2.736	0.40	0.88	5ASF000007125
SLFRS 75 Alu	165	6.496	165	6.496	65	2.559	76.5	3.012	0.43	0.95	5ASF000008716
SLFRS 100 Alu	195	7.677	195	7.677	65	2.559	101	3.976	0.40	0.88	5ASF000004042
SLFRS 125 Alu	213	8.386	213	8.386	65	2.559	126	4.961	0.60	1.32	5ASF000003956
SLFRS 150 Alu	236	9.291	236	9.291	65	2.559	151	5.945	0.80	1.76	5ASF000008717

Openable sleeves with flange, for RS seal



SLFO/RI acid-proof stainless steel

See practical user guidelines on page 264.

Acid-proof stainless steel

Sleeve	External flange diameter		Aperture diameter		Weight		Art. No
	ØA (mm)	ØA (in)	ØB (mm)	ØB (in)	(kg)	(lb)	
SLFO/RI 43 AISI 316	215	8.5	151	5.95	4.2	9.3	SLFORI0004321
SLFO/RI 50 AISI 316	226	8.9	162	6.4	4.7	10.4	SLFORI0005021
SLFO/RI 68 AISI 316	246	9.7	182	7.2	5.4	11.9	SLFORI0006821
SLFO/RI 75 AISI 316	252	9.9	188	7.4	5.5	12.1	SLFORI0007521
SLFO/RI 100 AISI 316	317	12.5	253	9.9	9.5	20.9	SLFORI0010021
SLFO/RI 125 AISI 316	343	13.5	279	10.9	10.8	23.8	SLFORI0012521
SLFO/RI 150 AISI 316	367	14.5	303	11.9	11.6	25.6	SLFORI0015021
SLFO/RI 175 AISI 316	392	15.4	328	12.9	12.6	27.8	SLFORI0017521
SLFO/RI 200 AISI 316	417	16.4	353	13.9	13.7	30.2	SLFORI0020021
SLFO/RI 225 AISI 316	450	17.7	386	15.2	16.8	37.1	SLFORI0022521
SLFO/RI 250 AISI 316	475	18.7	411	16.2	18.1	39.9	SLFORI0025021
SLFO/RI 300 AISI 316	525	20.7	461	18.2	20.5	45.2	SLFORI0030021
SLFO/RI 350 AISI 316	575	22.6	511	20.1	23.0	50.7	SLFORI0035021
SLFO/RI 400 AISI 316	625	24.6	561	22.1	25.5	56.2	SLFORI0040021
SLFO/RI 450 AISI 316	675	26.6	611	24.1	27.9	61.5	SLFORI0045021
SLFO/RI 500 AISI 316	725	28.5	661	26.1	30.4	67.1	SLFORI0050021
SLFO/RI 550 AISI 316	775	30.5	711	27.9	32.9	72.5	SLFORI0055021
SLFO/RI 600 AISI 316	825	32.5	761	29.9	35.3	77.8	SLFORI0060021
SLFO/RI 644 AISI 316	869	34.2	805	31.7	37.5	82.3	SLFORI0064421

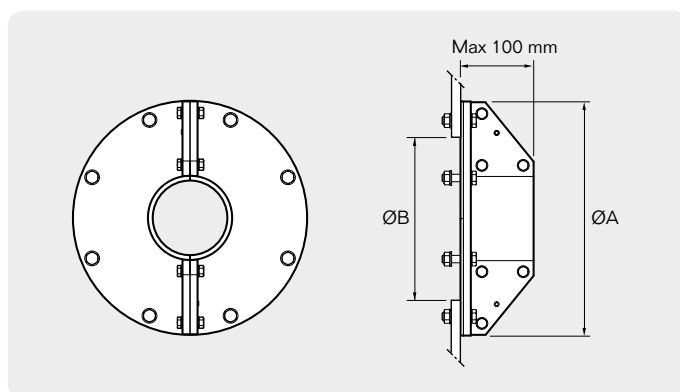



Roxtec RS OMD seal

The Roxtec RS OMD seal is a circular solution which protects single metal pipe penetrations. It can be adjusted on the outside to fit non-standard sleeve sizes, and its two halves and adaptable center are also equipped with Roxtec Multidiameter™ (removable layers for adaptability to pipes of different sizes).

- Tightness obtained by expansion within the seal
- Multiple pipe dimensions covered by one product size
- Single side installation
- Certified for fire, water and gas protection
- Adaptability on the outside to fit round openings of varying sizes
- Single pipe penetration

How it works

The example shows the features that make it quick and easy to install the RS OMD.

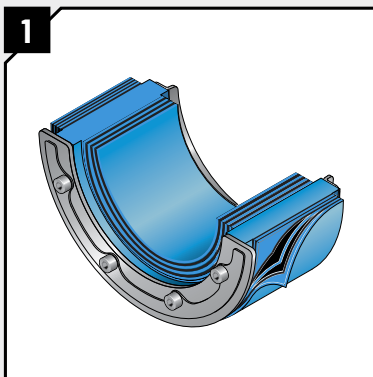

1 The Roxtec RS OMD has two halves equipped with removable layers on the outside. It can easily be adapted to fit openings of varying sizes and non-standard sleeve sizes.

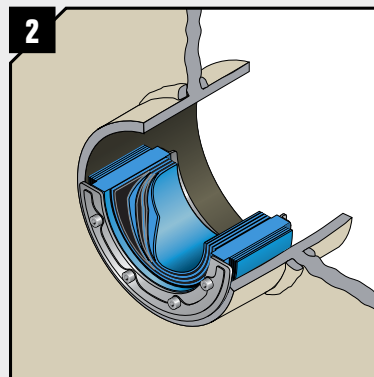

2 Each half of the seal is also equipped with removable layers inside in order to be adaptable to pipes of different sizes.

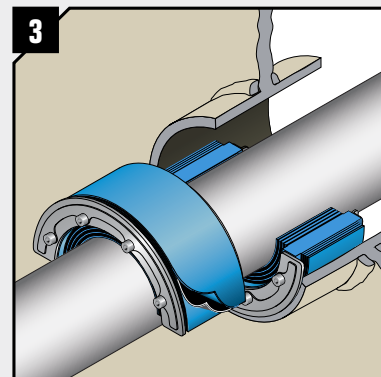

3 Each half is adapted on the inside and on the outside and the flexible solution is sealed by tightening the expansion mechanism.

RS OMD seal, acid-proof stainless steel fittings

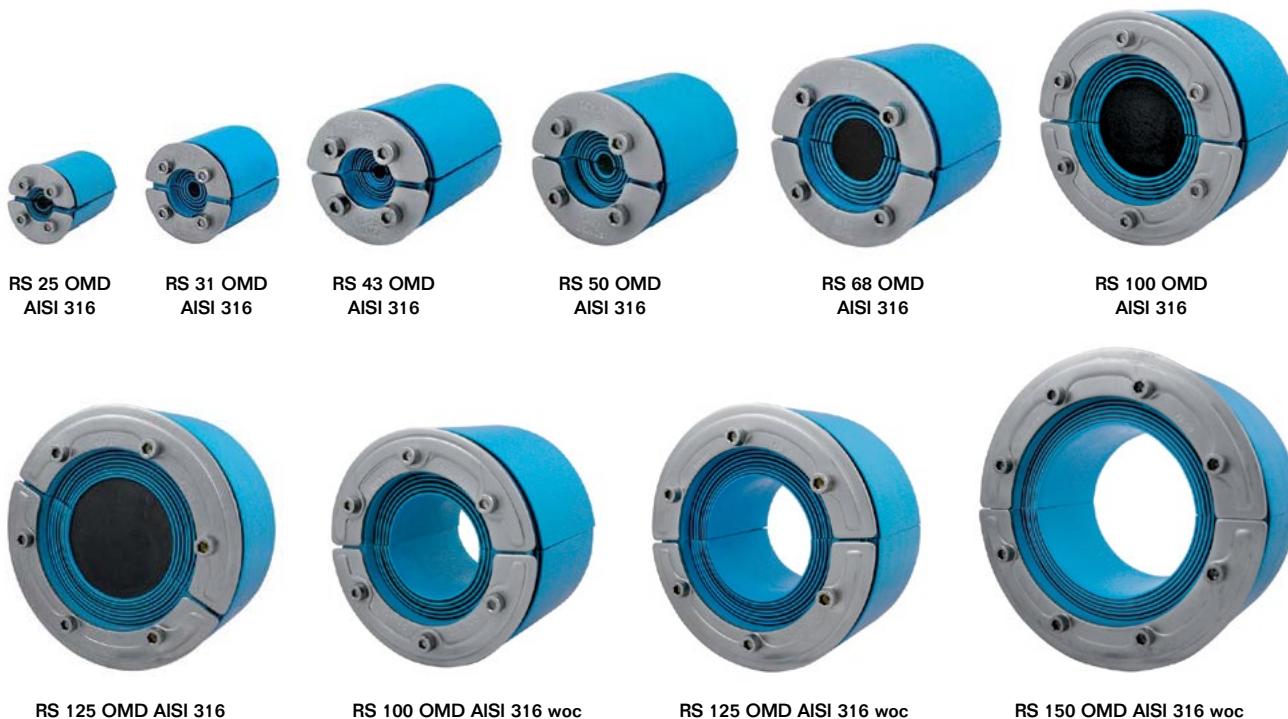

Installation instructions are available on www.roxtec.com

RATINGS Fire: A class Water pressure: 4 bar Gas pressure: 2.5 bar

Seal	For pipe Ø		For hole Ø		Weight		Art. No
	(mm)	(in)	(mm)	(in)	(kg)	(lb)	
WITH CORE							
RS 25 OMD AISI 316	0+3,6-12	0+0.142-0.472	25-30	0.984-1.181	0.05	0.121	RSO0100251021
RS 31 OMD AISI 316	0+4-17	0+0.157-0.669	31.5-35.5	1.240-1.398	0.06	0.132	RSO0100311021
RS 43 OMD AISI 316	0+4-23	0+0.157-0.906	43.5-51.0	1.713-2.008	0.2	0.441	RSO0100431021
RS 50 OMD AISI 316	0+8-30	0+0.315-1.181	50.5-58.0	1.988-2.283	0.3	0.661	RSO0100501021
RS 68 OMD AISI 316	0+26-48	0+1.024-1.890	69.0-76.5	2.717-3.012	0.5	1.102	RSO0100681021
RS 100 OMD AISI 316	0+48-70	0+1.890-2.756	101.0-108.0	3.976-4.252	1.0	2.205	RSO0101001021
RS 125 OMD AISI 316	0+66-98	0+2.598-3.858	126.0-143.0	4.961-5.630	1.9	4.058	RSO0101251021
WITHOUT CORE							
RS 100 OMD AISI 316 woc	48-70	1.890-2.756	101.0-108.0	3.976-4.252	0.9	1.984	RSO0001001021
RS 125 OMD AISI 316 woc	66-98	2.598-3.858	126.0-143.0	4.96 -5.630	1.2	2.756	RSO0001251021
RS 150 OMD AISI 316 woc	93-119	3.661-4.685	151.0-168.0	5.945-6.614	1.6	3.417	RSO0001501021

RS OMD seal, technical information

RS 25 OMD / RS 31 OMD / RS 43 OMD / RS 50 OMD / RS 68 OMD

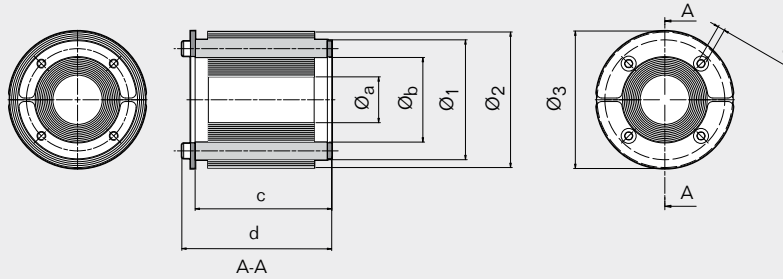

RS 100 OMD / RS 100 OMD woc / RS 125 OMD / RS 125 OMD woc

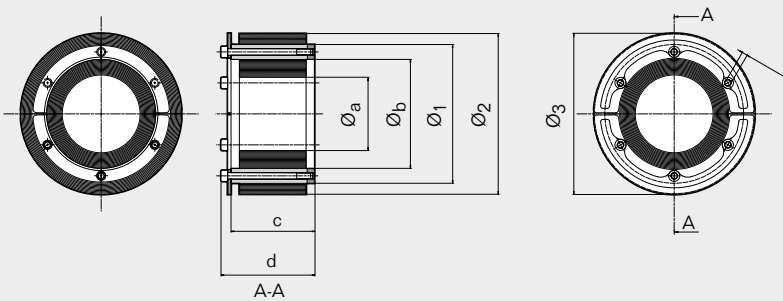

RS 150 OMD / RS 150 OMD woc

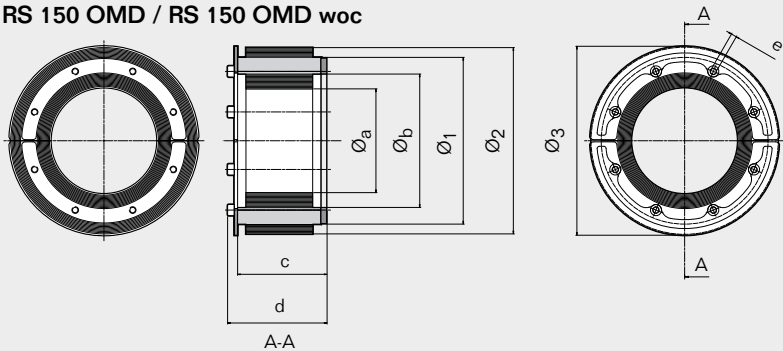

Pos	RS OMD 25		RS OMD 31		RS OMD 43		RS OMD 50		RS OMD 68		RS OMD 100		RS OMD 125		RS OMD 150		
	(mm)	(in)	(mm)	(in)	(mm)	(in)	(mm)	(in)	(mm)	(in)	(mm)	(in)	(mm)	(in)	(mm)	(in)	
Ø _a	3.6	0.142	4	0.157	4	0.157	8	0.315	26	1.024	48	1.890	66	2.598	93	3.661	
Ø _b	12	0.472	17	0.669	23	0.906	30	1.181	48	1.890	70	2.756	98	3.858	119	4.685	
Ø ₁	25	0.984	31	1.220	43	1.693	50	1.969	68	2.677	100	3.937	125	4.921	150	5.906	
Ø ₂	30	1.181	36	1.417	51	2.008	58	2.283	76	2.992	108	4.252	143	5.630	168	6.614	
Ø ₃	32	1.260	37	1.457	53	2.087	60	2.362	78	3.071	110	4.331	145	5.709	170	6.693	
c	38.5	1.516	40	1.575	78	3.071	78	3.071	78	3.071	78	3.071	78	3.071	79	3.110	
d	43	1.693	44	1.732	85	3.346	85	3.346	85	3.346	87	3.425	87	3.425	88	3.465	
e	*	*	*	*	**	**	**	**	**	**	**	**	**	***	***	****	****

* SW2.5 mm (4x) / SW0.098" (4x)

**** SW5 mm (6x) / SW0.197 (6x)

** SW4 mm (4x) / SW0.157 (4x)

***** SW5 mm (8x) / SW0.197 (8x)

*** SW4 mm (6x) / SW0.157 (6x)

Note: All dimensions are nominal values

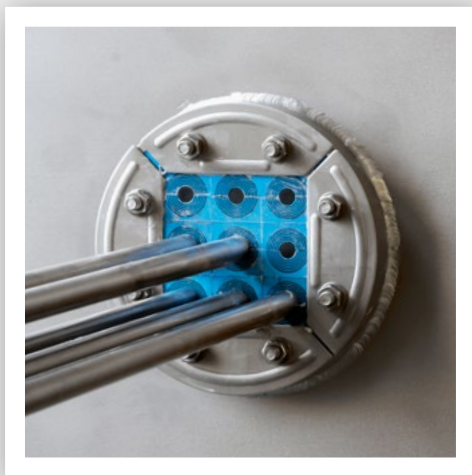

Roxtec R frame

The Roxtec R frame is a circular frame with a square packing space to encase RM modules with Multidiameter™. The solution protects multiple metal pipes penetrating an opening and also allows for “future included” planning by including extra capacity for metal pipe additions. The frame is simply inserted into the sleeve and compressed by expansion to seal the transit.

- Tightness obtained by expansion within the seal
- Multiple pipe dimensions covered by one product size
- Multiple pipe penetrations included within one opening in the deck or bulkhead
- Single side installation
- Certified fire, water and gas protection
- Sleeves are available

R frame, galvanized fittings



R 100 galv



R 125 galv



R 127 galv



R 150 galv



R 200 galv

See parts needed for a complete solution on page 26.

See sleeves on page 153.

See installation instructions on page 231.

RATINGS Fire: A class, H class Water pressure: 4 bar Gas pressure: 2.5 bar

Frame	Packing space (mm)	For hole Ø		Weight		Art. No
		(mm)	(in)	(kg)	(lb)	
R 100 galv	60 x 60	100-102	3.937-4.016	0.7	1.499	R000001001018
R 125 galv	80 x 80	125-127	4.921-5.000	1.1	2.447	R000001251018
R 127 galv	80 x 80	127-129	5.000-5.079	1.1	2.447	R000001271018
R 150 galv	90 x 90	150-152	5.906-5.984	1.6	3.638	R000001501018
R 200 galv	120 x 120	200-202	7.874-7.953	2.6	5.732	R000002001018

R frame, acid-proof stainless steel fittings



R 70 AISI 316



R 75 AISI 316



R 100 AISI 316



R 125 AISI 316



R 127 AISI 316



R 150 AISI 316

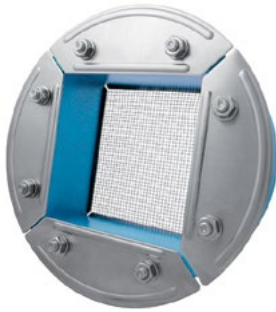

R 200 AISI 316

See parts needed for a complete solution on page 26.
See sleeves on page 153.
See installation instructions on page 231.

RATINGS

Fire: A class, H class

Water pressure: 4 bar

Gas pressure: 2.5 bar

Frame	Packing space (mm)	For hole Ø		Weight		Art. No
		(mm)	(in)	(kg)	(lb)	
R 70 AISI 316	40 x 40	70-72	2.756-2.835	0.5	1.014	R00000701021
R 75 AISI 316	40 x 40	75-77	2.953-3.031	0.5	1.102	R00000751021
R 100 AISI 316	60 x 60	100-102	3.937-4.016	0.6	1.499	R000001001021
R 125 AISI 316	80 x 80	125-127	4.921-5.000	1.1	2.447	R000001251021
R 127 AISI 316	80 x 80	127-129	5.000-5.079	1.1	2.447	R000001271021
R 150 AISI 316	90 x 90	150-152	5.906-5.984	1.6	3.638	R000001501021
R 200 AISI 316	120 x 120	200-202	7.874-7.953	2.6	5.732	R000002001021

R frame, technical information

R 70 / R 75

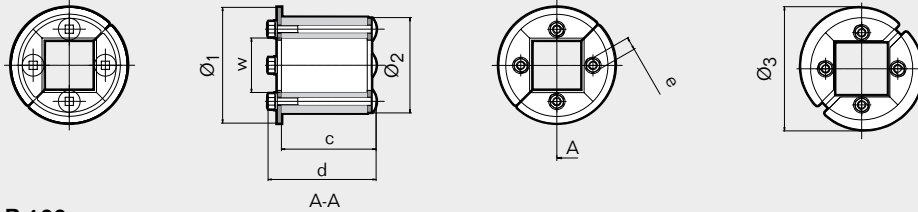

R 100

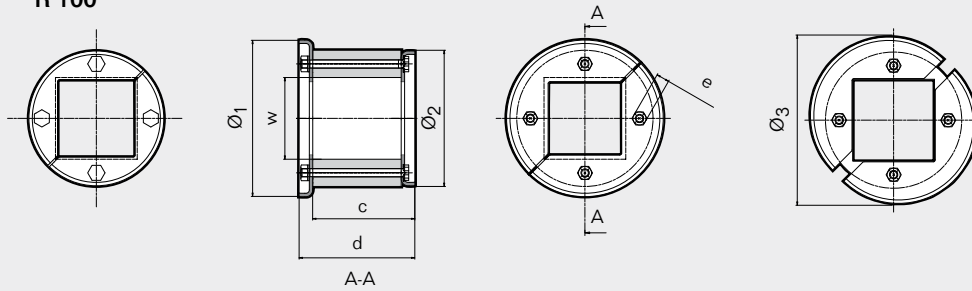

R 125 / R 127 / R 150 / R 200

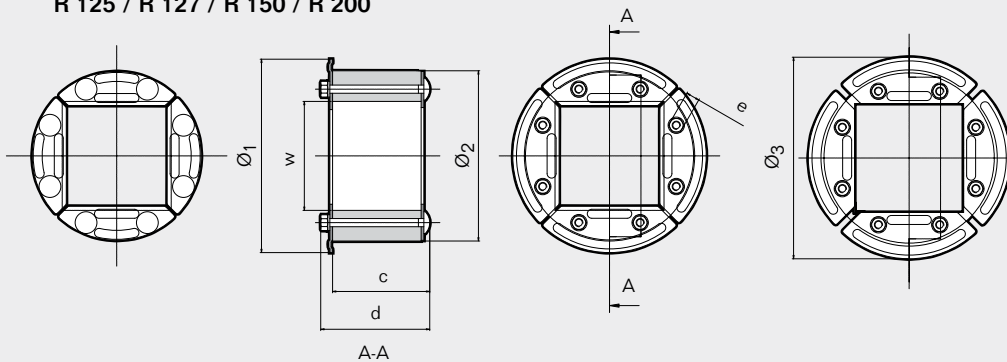

Pos	R 70		R 75		R 100		R 125		R 127		R 150		R 200	
	(mm)	(in)	(mm)	(in)	(mm)	(in)	(mm)	(in)	(mm)	(in)	(mm)	(in)	(mm)	(in)
\varnothing_1	85	3.346	85	3.346	115	4.528	142	5.591	142	5.591	165	6.496	215	8.465
\varnothing_2	70	2.756	75	2.953	100	3.937	125	4.921	127	5.000	150	5.906	200	7.874
\varnothing_3	91	3.583	91	3.583	125	4.921	148	5.827	148	5.827	171	6.732	223	8.780
w (□)	40	1.575	40	1.575	60	2.362	80	3.150	80	3.150	90	3.543	120	4.724
c	71	2.795	71	2.795	75	2.953	71	2.795	71	2.795	71	2.795	71	2.795
d	85	3.346	85	3.346	85	3.346	80	3.150	80	3.150	85	3.346	85	3.346
e	*	*	*	*	*	*	**	**	**	**	***	***	***	***

* SW10 mm (4x) / SW0.394" (4x) ** SW10 mm (8x) / SW0.394 (8x) *** SW13 mm (8x) / SW0.512 (8x)

\varnothing_3 = Dimension with front fittings in outer position.

Note: All dimensions are nominal values

Sleeves without flange, for R frame



SLR primed mild steel



SLR acid-proof stainless steel



SLR aluminum

See practical user guidelines on page 264.

Primed mild steel

Sleeve	External dimensions				Internal Ø		Weight		Art. No
	Ø (mm)	Ø (in)	L (mm)	L (in)	(mm)	(in)	(kg)	(lb)	
SLR 70 primed	83	3.262	55	2.165	71.5	2.815	0.58	1.27	ASLR100700012
SLR 75 primed	89	3.498	55	2.165	76.5	3.012	0.72	1.58	ASLR100750012
SLR 100 primed	114	4.480	55	2.165	101	3.976	0.93	2.05	ASLR101000012
SLR 125 primed	140	5.502	55	2.165	126	4.961	1.17	2.59	ASLR101250012
SLR 127 primed	140	5.502	55	2.165	128	5.039	1.01	2.23	ASLR101270012
SLR 150 primed	164	6.445	55	2.165	151	5.945	1.38	3.04	ASLR101500012
SLR 200 primed	214	8.410	55	2.165	201	7.913	1.80	3.97	ASLR102000012

Acid-proof stainless steel

Sleeve	External dimensions				Internal Ø		Weight		Art. No
	Ø (mm)	Ø (in)	L (mm)	L (in)	(mm)	(in)	(kg)	(lb)	
SLR 70 AISI 316	83	3.262	55	2.165	71.5	2.815	0.60	1.32	ASLR100700021
SLR 75 AISI 316	89	3.498	55	2.165	76.5	3.012	0.71	1.57	ASLR100750021
SLR 100 AISI316	114	4.480	55	2.165	101	3.976	0.96	2.12	ASLR101000021
SLR 125 AISI 316	140	5.502	55	2.165	126	4.961	1.21	2.66	ASLR101250021
SLR 127 AISI 316	140	5.502	55	2.165	128	5.039	1.09	2.41	ASLR101270021
SLR 150 AISI 316	164	6.445	55	2.165	151	5.945	1.39	3.07	ASLR101500021
SLR 200 AISI 316	214	8.410	55	2.165	201	7.913	1.85	4.07	ASLR102000021

Aluminum

Sleeve	External dimensions				Internal Ø		Weight		Art. No
	Ø (mm)	Ø (in)	L (mm)	L (in)	(mm)	(in)	(kg)	(lb)	
SLR 70 Alu	83	3.268	55	2.165	71.5	2.815	0.15	0.33	5ASLR00003974
SLR 75 Alu	89	3.504	55	2.165	76.5	3.012	0.22	0.49	5ASLR00008711
SLR 100 Alu	114	4.488	55	2.165	101	3.976	0.33	0.73	5ASLR00000894
SLR 125 Alu	140	5.512	55	2.165	126	4.961	0.40	0.88	5ASLR000007647
SLR 127 Alu	140	5.512	55	2.165	128	5.039	0.50	1.10	5ASLR00003246
SLR 150 Alu	164	6.457	55	2.165	151	5.945	0.45	0.99	5ASLR00003239
SLR 200 Alu	214	8.425	55	2.165	201	7.913	1.00	2.20	5ASLR00003240

Sleeves with flange, for R frame



SLFR primed mild steel



SLFR galvanized mild steel



SLFR aluminum

See practical user guidelines on page 264.

Primed mild steel

Sleeve	External flange Ø		External dimensions				Internal Ø		Weight		Art. No
	(mm)	(in)	Ø (mm)	Ø (in)	L (mm)	L (in)	(mm)	(in)	(kg)	(lb)	
SLFR 70 primed	160	6.299	160	6.299	55	2.165	71.5	2.815	1.05	2.31	ASFR100700012
SLFR 75 primed	165	6.496	165	6.496	55	2.165	76.5	3.012	1.20	2.63	ASFR100750012
SLFR 100 primed	195	7.677	195	7.677	55	2.165	101	3.976	1.58	3.48	ASFR101000012
SLFR 125 primed	213	8.386	213	8.386	55	2.165	126	4.961	1.82	4.00	ASFR101250012
SLFR 127 primed	213	8.386	213	8.386	55	2.165	128	5.039	1.67	3.68	ASFR101270012
SLFR 150 primed	236	9.291	236	9.291	55	2.165	151	5.945	2.10	4.63	ASFR101500012
SLFR 200 primed	290	11.417	290	11.417	55	2.165	201	7.913	2.78	6.13	ASFR102000012

Galvanized mild steel

Sleeve	External flange Ø		External dimensions				Internal Ø		Weight		Art. No
	(mm)	(in)	Ø (mm)	Ø (in)	L (mm)	L (in)	(mm)	(in)	(kg)	(lb)	
SLFR 70 galv	160	6.299	160	6.299	55	2.165	71.5	2.815	1.08	2.37	ASFR100700015
SLFR 75 galv	165	6.496	165	6.496	55	2.165	76.5	3.012	1.23	2.71	ASFR100750015
SLFR 100 galv	195	7.677	195	7.677	55	2.165	101	3.976	1.61	3.55	ASFR101000015
SLFR 125 galv	213	8.386	213	8.386	55	2.165	126	4.961	1.91	4.20	ASFR101250015
SLFR 127 galv	213	8.386	213	8.386	55	2.165	128	5.039	1.73	3.81	ASFR101270015
SLFR 150 galv	236	9.291	236	9.291	55	2.165	151	5.945	2.18	4.80	ASFR101500015
SLFR 200 galv	290	11.417	290	11.417	55	2.165	201	7.913	2.90	6.39	ASFR102000015

Aluminum

Sleeve	External flange Ø		External dimensions				Internal Ø		Weight		Art. No
	(mm)	(in)	Ø (mm)	Ø (in)	L (mm)	L (in)	(mm)	(in)	(kg)	(lb)	
SLFR 70 Alu	160	6.299	160	6.299	55	2.165	71.5	2.815	0.33	0.73	5ASFR00008713
SLFR 75 Alu	165	6.496	165	6.496	55	2.165	76.5	3.012	0.40	0.88	5ASF000008712
SLFR 100 Alu	195	7.677	195	7.677	55	2.165	101	3.976	0.53	1.17	5ASFR00001917
SLFR 125 Alu	213	8.386	213	8.386	55	2.165	126	4.961	0.63	1.39	5ASF000004286
SLFR 127 Alu	213	8.386	213	8.386	55	2.165	128	5.039	0.57	1.26	5ASFR00008714
SLFR 150 Alu	236	9.291	236	9.291	55	2.165	151	5.945	0.71	1.57	5ASFR00007671
SLFR 200 Alu	290	11.417	290	11.417	55	2.165	201	7.913	0.96	2.12	5ASFR00001918

Openable sleeves with flange, for R frame



SLFO/RI acid-proof stainless steel

See practical user guidelines on page 264.

Acid-proof stainless steel

Sleeve	External flange diameter		Aperture diameter		Weight		Art. No
	ØA (mm)	ØA (in)	ØB (mm)	ØB (in)	(kg)	(lb)	
SLFO/RI 75 AISI 316	252	9.9	188	7.4	5.5	12.1	SLFORI0007521
SLFO/RI 100 AISI 316	317	12.5	253	9.9	9.5	20.9	SLFORI0010021
SLFO/RI 125 AISI 316	343	13.5	279	10.9	10.8	23.8	SLFORI0012521
SLFO/RI 150 AISI 316	367	14.5	303	11.9	11.6	25.6	SLFORI0015021
SLFO/RI 200 AISI 316	417	16.4	353	13.9	13.7	3	SLFORI0020021

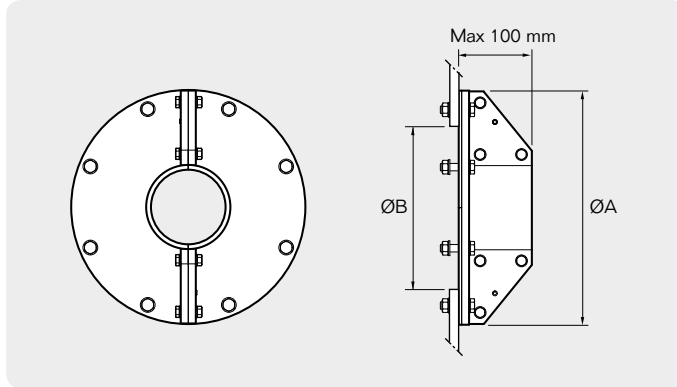



Roxtec SPM™ seal

The Roxtec SPM is a non-weld solution for any kind of metal pipe. It maintains a tight seal around the pipe as well as inside an uneven opening. The seal is quick and easy to install from only one side of steel decks or bulkheads which may range in thickness from 6 to 15 mm.

- Light-weight
- Single pipe penetration
- Single-side installation
- Non-weld solution
- Certified fire, water and gas protection

How it works

The example shows the features that make it a quick and easy process to install the Roxtec SPM seal.

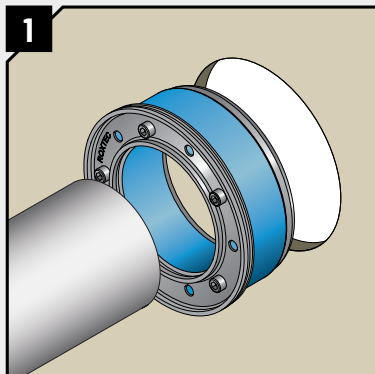

1 Slide the pipe through the Roxtec SPM seal and insert it into the opening. The seal copes with wide tolerances towards both pipe and opening.

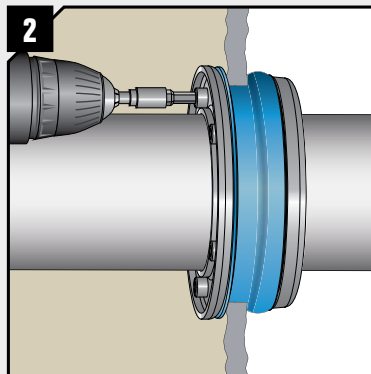

2 Fit the seal against the inside of the opening and tighten the bolts. It maintains a tight seal around the pipe and inside the opening.

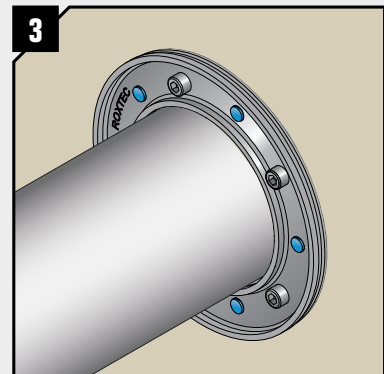

3 The indicators show when full compression is achieved in order to simplify both installation and inspection.

SPM™ seal, acid-proof stainless steel fittings



SPM 81

SPM 138

See installation instructions on page 235.

RATINGS Fire: A class Water pressure: 1 bar Gas pressure: 0.67 bar

Seal	For pipe outside Ø		For hole Ø		Weight		Art. no
	(mm)	(in)	(mm)	(in)	(kg)	(lb)	
SPM 41	12-16	0.472 - 0.630	41-45	1.614-1.772	0.1	0.263	153052
SPM 54	19-23	0.748 - 0.906	53.5-57.5	2.106-2.264	0.2	0.441	153060
SPM 59	24-28	0.945 - 1.102	58.5-62.5	2.303-2.461	0.3	0.551	153064
SPM 62	27-31	1.063 - 1.220	61.5-65.5	2.421-2.579	0.3	0.573	153068
SPM 69	32-36	1.260 - 1.417	68.5-72.5	2.697-2.854	0.3	0.683	153072
SPM 81	41.4-45.4	1.630 - 1.787	81-85	3.189-3.346	0.5	1.014	153040
SPM 87	47-51	1.850 - 2.008	87-91	3.425-3.583	0.5	1.102	153076
SPM 92	52-56	2.047 - 2.205	92-96	3.622-3.779	0.5	1.168	153080
SPM 103	56.2-61.1	2.213 - 2.406	103-107	4.055-4.213	0.7	1.433	153084
SPM 119	72.2-76.9	2.843 - 3.028	119-123	4.685-4.843	0.8	1.720	153088
SPM 138	88-92	3.465 - 3.622	138-142	5.433-5.591	1.1	2.315	153056
SPM 157	107-111	4.213 - 4.370	157-161	6.181-6.339	1.2	2.734	153092
SPM 168	113-117	4.449 - 4.606	168-172	6.614-6.772	1.6	3.461	153096
SPM 196	138.5-143	5.453 - 5.630	196-200	7.717-7.874	1.9	4.255	153100
SPM 226	167-171	6.575 - 6.732	226-230	8.898-9.055	2.4	5.291	153104
SPM 279	218-222	8.583 - 8.740	279-283	10.984-11.142	3.0	6.702	153036

SPM™ seal, technical information

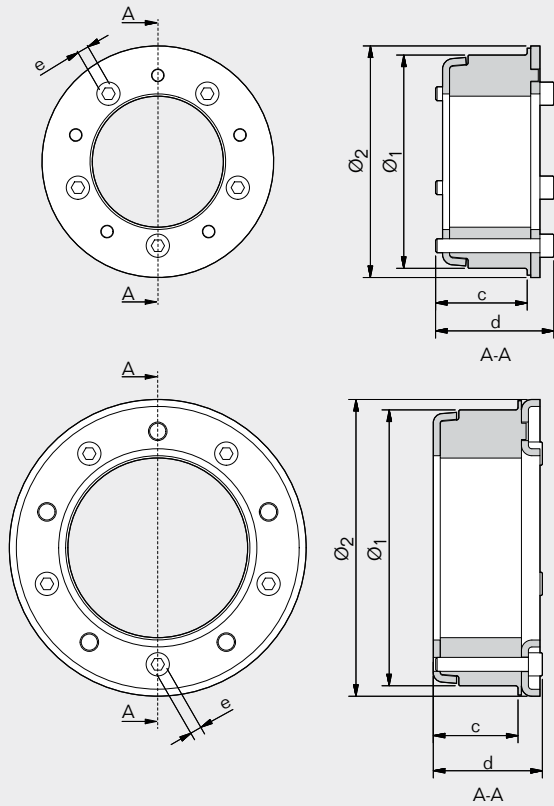

	SPM 41		SPM 54		SPM 59		SPM 62		SPM 69		SPM 81		SPM 87		SPM 92	
Pos	(mm)	(in)	(mm)	(in)	(mm)	(in)	(mm)	(in)	(mm)	(in)	(mm)	(in)	(mm)	(in)	(mm)	(in)
Ø ₁	41	1.614	53.5	2.106	58.5	2.303	61.5	2.421	68.5	2.697	81	3.189	87	3.425	92	3.622
Ø ₂	51	2.008	64	2.520	69	2.717	72	2.835	79	3.110	89	3.504	95	3.740	100	3.937
c	41	1.614	40	1.575	37	1.457	37	1.457	37	1.457	40	1.575	40	1.575	40	1.575
d	49	1.929	49	1.929	47	1.850	47	1.850	47	1.850	51	2.008	51	2.008	51	2.008
e	*	*	*	*	**	**	**	**	**	**	***	***	***	***	***	***

	SPM 103		SPM 119		SPM 138		SPM 157		SPM 168		SPM 196		SPM 226		SPM 279	
Pos	(mm)	(in)	(mm)	(in)	(mm)	(in)	(mm)	(in)	(mm)	(in)	(mm)	(in)	(mm)	(in)	(mm)	(in)
Ø ₁	103	4.055	119	4.685	138	5.433	157	6.181	168	6.614	196	7.717	226	8.898	279	10.984
Ø ₂	112	4.409	128	5.039	147	5.787	166	6.535	180	7.087	206	8.110	238	9.370	291	11.457
c	41	1.614	37	1.457	41	1.614	41	1.614	46	1.811	46	1.811	46	1.811	46	1.811
d	51	2.008	47	1.850	51	2.008	51	2.008	58	2.283	58	2.283	58	2.283	58	2.283
e	***	***	***	***	***	***	***	***	****	****	****	****	****	****	****	****

* SW3 mm/SW0.118"
 ** SW4 mm/SW0.157"
 *** SW5 mm/SW0.197"
 **** SW6 mm/SW0.236"

Note: All dimensions are nominal values



Roxtec R X, RS X seals

The Roxtec R X and RS X seals are designed for retrofit or installations late in the process when welding is not allowed. The kit consists of a non-welding sleeve (SLX) and an RS seal for a single pipe penetration or an R frame for multiple pipes. The R X solution also provides built-in spare capacity for future upgrades.

- R X for use with RM modules
- Single or multiple metal pipe penetrations
- Multiple pipe dimensions covered by one product size
- Single side installation
- Certified fire, water and gas protection

How it works

The example shows the features that allow the RS X to be installed in a deck or bulkhead without welding.

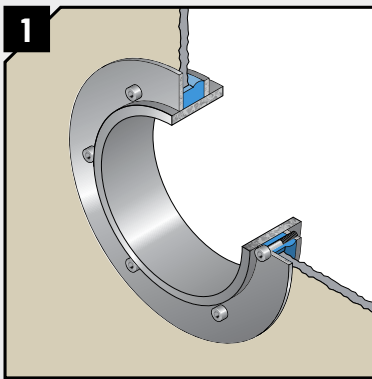

1 The Roxtec RS X is attached through expansion. Its rubber compresses and expands towards the inside of the opening to create tightness between the structure and the SLX sleeve (included in the kit).

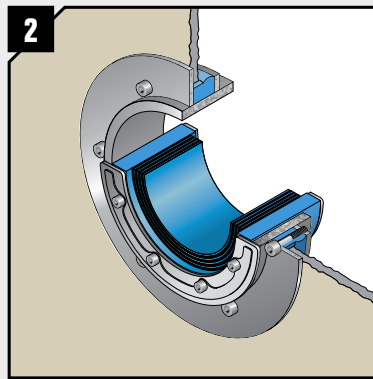

2 The standard operation of the seal also compresses the rubber against the outside of the pipe.

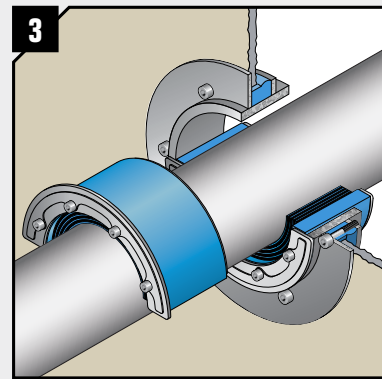

3 Each half of the seal is equipped with removable layers in order to be adaptable to any pipe.

R X kits, galvanized with galvanized sleeve



R X 100 galv/galv

See information and measurements for R frame on page 152.
See parts needed for a complete solution on page 26.
Installation instructions are available on www.roxtec.com

RATINGS		Fire: A class		Water pressure: 4 bar		Gas pressure: 2.5 bar		
Kit	Packing space (mm)	Aperture dim. ± 1 mm (0.0394")		External dimensions sleeve		Weight sleeve		Art. No
		\varnothing (mm)	\varnothing (in)	$\varnothing \times D$ (mm)	$\varnothing \times D$ (in)	(kg)	(lb)	
R X 100 galv/galv	60 x 60	146	5.748	155 x 55	6.102 x 2.165	2.2	4.850	RXG0001001018
R X 125 galv/galv	80 x 80	171	6.732	180 x 55	7.087 x 2.165	2.8	6.173	RXG0001251018
R X 150 galv/galv	90 x 90	200	7.874	209 x 55	8.228 x 2.165	3.5	7.716	RXG0001501018
R X 200 galv/galv	120 x 120	251	9.882	260 x 55	10.236 x 2.165	4.6	10.141	RXG0002001018

R X kits, acid-proof stainless steel with galvanized sleeve



R X 100 AISI 316/galv

See information and measurements for R frame on page 152.
See parts needed for a complete solution on page 26.
Installation instructions are available on www.roxtec.com

RATINGS		Fire: A class		Water pressure: 4 bar		Gas pressure: 2.5 bar		
Kit	Packing space (mm)	Aperture dim. ± 1 mm (0.0394")		External dimensions sleeve		Weight sleeve		Art. No
		\varnothing (mm)	\varnothing (in)	$\varnothing \times D$ (mm)	$\varnothing \times D$ (in)	(kg)	(lb)	
R X 75 AISI 316/galv	40 x 40	116	4.567	125 x 55	4.921 x 2.165	1.6	3.527	RXG0000751021
R X 100 AISI 316/galv	60 x 60	146	5.748	155 x 55	6.102 x 2.165	2.2	4.850	RXG0001001021
R X 125 AISI 316/galv	80 x 80	171	6.732	180 x 55	7.087 x 2.165	2.8	6.173	RXG0001251021
R X 150 AISI 316/galv	90 x 90	200	7.874	209 x 55	8.228 x 2.165	3.5	7.716	RXG0001501021
R X 200 AISI 316/galv	120 x 120	251	9.882	260 x 55	10.236 x 2.165	4.6	10.141	RXG0002001021

RS X kits, acid-proof stainless steel with galvanized sleeve



RS X 100 AISI 316/galv



RS X 100 AISI 316 woc/galv

See information and measurements for RS seal on page 140.

Installation instructions are available on www.roxtec.com

RATINGS Fire: A class Water pressure: 4 bar Gas pressure: 2.5 bar

Kit	For pipe Ø		Aperture dim. ± 1 mm (0.0394")		External dimensions sleeve		Weight		Art. No
	(mm)	(in)	Ø (mm)	Ø (in)	ØxD (mm)	ØxD (in)	(kg)	(lb)	
WITH CORE									
RS X 43 AISI 316/galv	0+4-23	0+0.157-0.906	83	3.268	92 x 65	3.622 x 2.559	0.8	1.764	RSXG100431021
RS X 50 AISI 316/galv	0+8-30	0+0.315-1.181	91	3.583	100 x 65	3.937 x 2.559	1.2	2.646	RSXG100501021
RS X 75 AISI 316/galv	0+24-54	0+0.945-2.126	116	4.567	125 x 65	4.921 x 2.559	1.6	3.527	RSXG100751021
RS X 100 AISI 316/galv	0+48-70	0+1.890-2.756	146	5.748	155 x 65	6.102 x 2.559	2.2	4.850	RSXG101001021
RS X 125 AISI 316/galv	0+66-98	0+2.598-3.858	171	6.732	180 x 65	7.087 x 2.559	2.8	6.173	RSXG101251021
WITHOUT CORE									
RS X 100 AISI 316 woc/galv	48-70	1.890-2.756	146	5.748	155 x 65	6.102 x 2.559	2.2	4.850	RSXG001001021
RS X 125 AISI 316 woc/galv	66-98	2.598-3.858	171	6.732	180 x 65	7.087 x 2.559	2.8	6.173	RSXG001251021
RS X 150 AISI 316 woc/galv	93-119	3.661-4.685	200	7.874	209 x 65	8.228 x 2.559	3.5	7.716	RSXG001501021
RS X 175 AISI 316 woc/galv	119-145	4.685-5.709	221	8.701	230 x 65	9.055 x 2.559	5.03	11.089	RSXG001751021
RS X 200 AISI 316 woc/galv	138-170	5.433-6.693	251	9.882	260 x 65	10.236 x 2.559	6.55	14.440	RSXG002001021

R X, RS X kits, technical information

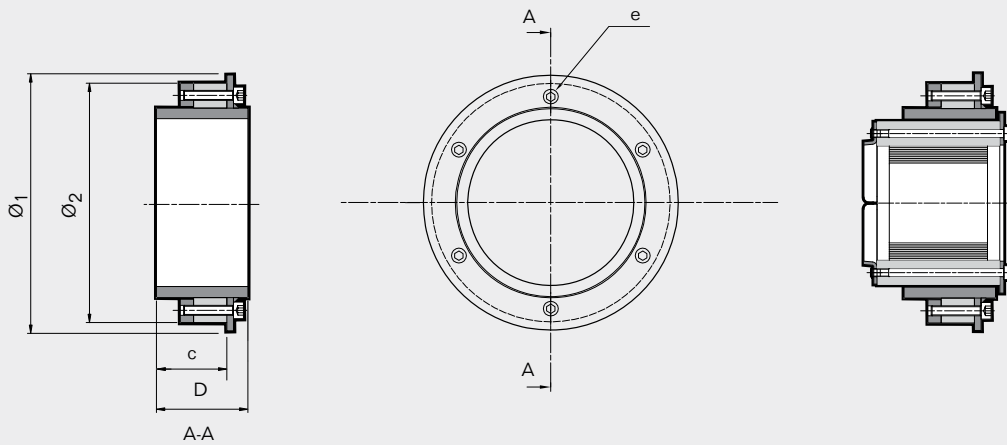

	R X 75		R X 100		R X 125		R X 150		R X 200	
Pos	(mm)	(in)	(mm)	(in)	(mm)	(in)	(mm)	(in)	(mm)	(in)
Ø ₁	125	4.921	155	6.102	180	7.087	209	8.228	260	10.236
Ø ₂	115	4.528	145	5.709	170	6.693	199	7.835	250	9.843
c	43	1.693	43	1.693	43	1.693	43	1.693	43	1.693
D	55	2.165	55	2.165	55	2.165	55	2.165	55	2.165
e	*	*	**	**	**	**	**	**	***	***

* SW 5 mm (4x) / SW 0.197" (4x) ** SW 5 mm (6x) / SW 0.197" (6x) *** SW 5 mm (8x) / SW 0.197" (8x)

	RS X 43		RS X 50		RS X 75		RS X 100 (woc)		RS X 125 (woc)	
Pos	(mm)	(in)	(mm)	(in)	(mm)	(in)	(mm)	(in)	(mm)	(in)
Ø ₁	92	3.622	100	3.937	125	4.921	155	6.102	180	7.087
Ø ₂	82	3.228	90	3.543	115	4.527	145	5.709	170	6.693
c	53	2.087	53	2.087	53	2.087	53	2.087	53	2.087
D	65	2.559	65	2.559	65	2.559	65	2.559	65	2.559
e	****	****	****	****	*****	*****	*****	*****	*****	*****

**** SW 4 mm (4x) / SW 0.157" (4x) ***** SW 5 mm (6x) / SW 0.197" (6x)

	RS X 150 (woc)		RS X 175 (woc)		RS X 200 (woc)	
Pos	(mm)	(in)	(mm)	(in)	(mm)	(in)
Ø ₁	209	8.228	230	9.055	260	10.236
Ø ₂	199	7.835	220	8.661	250	9.843
c	53	2.087	53	2.087	53	2.087
D	65	2.559	65	2.559	65	2.559
e	*****	*****	*****	*****	*****	*****

***** SW 5 mm (6x) / SW 0.197" (6x)

Note: All dimensions are nominal values



Roxtec S frame

The Roxtec S frame is a metal frame attached by welding. It comes as a single opening or in various combination options and provides packing space for numerous sizes of Roxtec RM modules with Multidiameter™. The solution protects multiple metal pipe penetrations and also allows for “future included” planning by including extra capacity for future metal pipe additions.

- For use with Group RM components
- Attachment by welding
- Multiple pipe dimensions covered by one product size
- Multiple pipe penetrations included within one opening in the deck or bulkhead
- Single side installation
- Certified fire, water and gas protection

S frame, primed mild steel



S 6x1 primed

See parts needed for a complete solution on page 26.

See installation instructions on page 222.

See practical user guidelines on page 264.

Remove primer from the inside of the frame to ensure good conductivity in EMC applications.

For information about other frame combinations, or for openable versions of this frame, please contact your local Roxtec supplier or e-mail: info@roxtec.com

RATINGS

Fire: A class, H class

Water pressure: 4 bar

Gas pressure: 2.5 bar

Frame	Frame openings	Packing space (mm)	External dimensions (D=60 mm)		Weight		Art. No
			HxW (mm)	HxW (in)	(kg)	(lb)	
S 1x1 primed	1	60 x 60	121 x 80	4.764 x 3.150	1.6	3.527	SS01000000112
S 2x1 primed	1	60 x 120	121 x 141	4.764 x 5.551	2.2	4.938	S002000000112
S 2x2 primed	2	60 x 120	121 x 271	4.764 x 10.669	3.9	8.488	S002000000212
S 2x3 primed	3	60 x 120	121 x 402	4.764 x 15.827	5.5	12.037	S002000000312
S 2x4 primed	4	60 x 120	121 x 532	4.764 x 20.945	7.1	15.609	S002000000412
S 2x5 primed	5	60 x 120	121 x 663	4.764 x 26.102	8.7	19.158	S002000000512
S 2x6 primed	6	60 x 120	121 x 793	4.764 x 31.220	10.3	22.707	S002000000612
S 3x1 primed	1	120 x 60	180 x 80	7.087 x 3.150	2.3	5.071	SS03000000112

S frame, primed mild steel

Frame	Frame openings	Packing space (mm)	External dimensions (D=60 mm)		Weight		Art. No
			HxW (mm)	HxW (in)	(kg)	(lb)	
S 4x1 primed	1	120 x 120	180 x 141	7.087 x 5.551	2.8	6.151	S004000000112
S 4x2 primed	2	120 x 120	180 x 271	7.087 x 10.669	4.7	10.318	S004000000212
S 4x3 primed	3	120 x 120	180 x 402	7.087 x 15.827	6.6	14.484	S004000000312
S 4x4 primed	4	120 x 120	180 x 532	7.087 x 20.945	8.5	18.629	S004000000412
S 4x5 primed	5	120 x 120	180 x 663	7.087 x 26.102	10.3	22.796	S004000000512
S 4x6 primed	6	120 x 120	180 x 793	7.087 x 31.220	12.2	26.962	S004000000612
S 4x7 primed	7	120 x 120	180 x 924	7.087 x 36.378	14.1	31.129	S004000000712
S 4x8 primed	8	120 x 120	180 x 1054	7.087 x 41.496	16.0	35.296	S004000000812
S 4x9 primed	9	120 x 120	180 x 1185	7.087 x 46.654	17.9	39.440	S004000000912
S 4+4x1 primed	2	120 x 120	349 x 141	13.740 x 5.551	5.0	11.067	S004400000112
S 4+4x2 primed	4	120 x 120	359 x 271	14.134 x 10.669	9.5	20.878	S004400000212
S 4+4x3 primed	6	120 x 120	359 x 402	14.134 x 15.827	13.5	29.321	S004400000312
S 4+4x4 primed	8	120 x 120	359 x 532	14.134 x 20.945	17.1	37.743	S004400000412
S 4+4x5 primed	10	120 x 120	359 x 663	14.134 x 26.102	21.0	46.186	S004400000512
S 4+4x6 primed	12	120 x 120	359 x 793	14.134 x 31.220	24.8	54.630	S004400000612
S 4+4x7 primed	14	120 x 120	359 x 924	14.134 x 36.378	28.6	63.096	S004400000712
S 4+4x8 primed	16	120 x 120	359 x 1054	14.134 x 41.496	32.6	71.539	S004400000812
S 4+4+4x1 primed	3	120 x 120	519 x 141	20.433 x 5.551	6.6	14.550	S004440000112
S 4+4+4x2 primed	6	120 x 120	539 x 271	21.220 x 10.669	14.2	31.305	S004440000212
S 4+4+4x3 primed	9	120 x 120	539 x 402	21.220 x 15.827	19.9	43.872	S004440000312
S 4+4+4x4 primed	12	120 x 120	539 x 532	21.220 x 20.945	26.2	57.761	S004440000412
S 4+4+4x5 primed	15	120 x 120	539 x 663	21.220 x 26.102	31.3	69.004	S004440000512
S 4+4+4x6 primed	18	120 x 120	539 x 793	21.220 x 31.220	37.0	81.570	S004440000612
S 5x1 primed	1	180 x 60	238 x 80	9.370 x 3.150	2.8	6.173	SS05000000112
S 6x1 primed	1	180 x 120	238 x 141	9.370 x 5.551	3.3	7.363	S006000000112
S 6x2 primed	2	180 x 120	238 x 271	9.370 x 10.669	5.5	12.147	S006000000212
S 6x3 primed	3	180 x 120	238 x 402	9.370 x 15.827	7.7	16.909	S006000000312
S 6x4 primed	4	180 x 120	238 x 532	9.370 x 20.945	9.8	21.671	S006000000412
S 6x5 primed	5	180 x 120	238 x 663	9.370 x 26.102	12.0	26.455	S006000000512
S 6x6 primed	6	180 x 120	238 x 793	9.370 x 31.220	14.2	31.217	S006000000612
S 6x7 primed	7	180 x 120	238 x 924	9.370 x 36.378	16.3	35.979	S006000000712
S 6x8 primed	8	180 x 120	238 x 1054	9.370 x 41.496	18.5	40.763	S006000000812
S 6x9 primed	9	180 x 120	238 x 1185	9.370 x 46.654	20.7	45.525	S006000000912
S 6+6x1 primed	2	180 x 120	466 x 141	18.346 x 5.551	6.1	13.492	S006600000112
S 6+6x2 primed	4	180 x 120	476 x 271	18.740 x 10.669	11.1	24.537	S006600000212
S 6+6x3 primed	6	180 x 120	476 x 402	18.740 x 15.827	15.5	34.171	S006600000312
S 6+6x4 primed	8	180 x 120	476 x 532	18.740 x 20.945	19.9	43.827	S006600000412
S 6+6x5 primed	10	180 x 120	476 x 663	18.740 x 26.102	24.3	53.506	S006600000512

S frame, primed mild steel

Frame	Frame openings	Packing space (mm)	External dimensions (D=60 mm)		Weight		Art. No
			HxW (mm)	HxW (in)	(kg)	(lb)	
S 6+6x6 primed	12	180 x 120	476 x 793	18.740 x 31.220	28.6	63.140	S006600000612
S 6+6x7 primed	14	180 x 120	476 x 924	18.740 x 36.378	33.0	72.796	S006600000712
S 6+6x8 primed	16	180 x 120	476 x 1054	18.740 x 41.496	37.4	82.474	S006600000812
S 6+6x9 primed	18	180 x 120	476 x 1185	18.740 x 46.654	41.8	92.108	S006600000912
S 6+6x10 primed	20	180 x 120	476 x 1315	18.740 x 51.772	46.2	101.764	S006600001012
S 6+6+6x1 primed	3	180 x 120	694 x 141	27.323 x 5.551	8.2	18.078	S006660000112
S 7x1 primed	1	240 x 60	298 x 80	11.732 x 3.150	3.3	7.363	SS07000000112
S 8x1 primed	1	240 x 120	298 x 141	11.732 x 5.551	3.9	8.620	S008000000112
S 8x2 primed	2	240 x 120	298 x 271	11.732 x 10.669	6.1	13.382	S008000000212
S 8x3 primed	3	240 x 120	298 x 402	11.732 x 15.827	8.2	18.144	S008000000312
S 8x4 primed	4	240 x 120	298 x 532	11.732 x 20.945	10.4	22.928	S008000000412
S 8x5 primed	5	240 x 120	298 x 663	11.732 x 26.102	12.6	27.690	S008000000512
S 8x6 primed	6	240 x 120	298 x 793	11.732 x 31.220	14.7	32.452	S008000000612
S 8+8x1 primed	2	240 x 120	586 x 141	23.071 x 5.551	7.3	16.005	S008800000112
S 8+8x2 primed	4	240 x 120	596 x 271	23.465 x 10.669	12.3	27.006	S008800000212
S 8+8x3 primed	6	240 x 120	596 x 402	23.465 x 15.827	16.6	36.640	S008800000312
S 8+8x4 primed	8	240 x 120	596 x 532	23.465 x 20.945	21.0	46.341	S008800000412
S 8+8x5 primed	10	240 x 120	596 x 663	23.465 x 26.102	25.4	55.975	S008800000512
S 8+8x6 primed	12	240 x 120	596 x 793	23.465 x 31.220	29.8	65.609	S008800000612
S 8+8x7 primed	14	240 x 120	596 x 924	23.465 x 36.378	34.2	75.309	S008800000712
S 8+8x8 primed	16	240 x 120	596 x 1054	23.465 x 41.496	38.5	84.943	S008800000812
S 8+8x9 primed	18	240 x 120	596 x 1185	23.465 x 46.654	42.9	94.577	S008800000912
S 8+8x10 primed	20	240 x 120	596 x 1315	23.465 x 51.772	47.3	104.278	S008800001012
S 8+8+8x1 primed	3	240 x 120	874 x 141	34.409 x 5.551	9.9	21.826	S008880000112

S frame, acid-proof stainless steel



S 6x1 AISI 316

See parts needed for a complete solution on page 26.

See installation instructions on page 222.

See practical user guidelines on page 264.

For information about other frame combinations, or for openable versions of this frame, please contact your local Roxtec supplier or e-mail: info@roxtec.com

RATINGS							
Fire: A class, H class		Water pressure: 4 bar		Gas pressure: 2.5 bar			
Frame	Frame openings	Packing space (mm)	External dimensions (D=60 mm)		Weight		Art. No
			HxW (mm)	HxW (in)	(kg)	(lb)	
S 2x1 AISI 316	1	60 x 120	121 x 141	4.764 x 5.551	2.2	4.938	S002000000121
S 2x2 AISI 316	2	60 x 120	121 x 271	4.764 x 10.669	3.9	8.488	S002000000221
S 2x3 AISI 316	3	60 x 120	121 x 402	4.764 x 15.827	5.5	12.037	S002000000321
S 2x4 AISI 316	4	60 x 120	121 x 532	4.764 x 20.945	7.1	15.609	S002000000421
S 2x5 AISI 316	5	60 x 120	121 x 663	4.764 x 26.102	8.7	19.158	S002000000521
S 2x6 AISI 316	6	60 x 120	121 x 793	4.764 x 31.220	10.3	22.707	S002000000621
S 4x1 AISI 316	1	120 x 120	180 x 141	7.087 x 5.551	2.8	6.151	S004000000121
S 4x2 AISI 316	2	120 x 120	180 x 271	7.087 x 10.669	4.7	10.318	S004000000221
S 4x3 AISI 316	3	120 x 120	180 x 402	7.087 x 15.827	6.6	14.484	S004000000321
S 4x4 AISI 316	4	120 x 120	180 x 532	7.087 x 20.945	8.5	18.629	S004000000421
S 4x5 AISI 316	5	120 x 120	180 x 663	7.087 x 26.102	10.3	22.796	S004000000521
S 4x6 AISI 316	6	120 x 120	180 x 793	7.087 x 31.220	12.2	26.962	S004000000621
S 4+4x1 AISI 316	2	120 x 120	349 x 141	13.740 x 5.551	5.0	11.067	S004400000121
S 4+4+4x1 AISI 316	3	120 x 120	519 x 141	20.433 x 5.551	6.6	14.550	S004440000121
S 6x1 AISI 316	1	180 x 120	238 x 141	9.370 x 5.551	3.3	7.363	S006000000121
S 6x2 AISI 316	2	180 x 120	238 x 271	9.370 x 10.669	5.5	12.147	S006000000221
S 6x3 AISI 316	3	180 x 120	238 x 402	9.370 x 15.827	7.7	16.909	S006000000321
S 6x4 AISI 316	4	180 x 120	238 x 532	9.370 x 20.945	9.8	21.671	S006000000421
S 6x5 AISI 316	5	180 x 120	238 x 663	9.370 x 26.102	12.0	26.455	S006000000521
S 6x6 AISI 316	6	180 x 120	238 x 793	9.370 x 31.220	14.2	31.217	S006000000621
S 6+6x1 AISI 316	2	180 x 120	466 x 141	18.346 x 5.551	6.1	13.492	S006600000121
S 6+6x2 AISI 316	4	180 x 120	476 x 271	18.740 x 10.669	11.1	24.537	S006600000221
S 6+6x3 AISI 316	6	180 x 120	476 x 402	18.740 x 15.827	15.5	34.171	S006600000321
S 6+6x4 AISI 316	8	180 x 120	476 x 532	18.740 x 20.945	19.9	43.872	S006600000421
S 6+6x5 AISI 316	10	180 x 120	476 x 663	18.740 x 26.102	24.3	53.506	S006600000521
S 6+6x6 AISI 316	12	180 x 120	476 x 793	18.740 x 31.220	28.6	63.140	S006600000621

S frame, acid-proof stainless steel

Frame	Frame openings	Packing space (mm)	External dimensions (D=60 mm)		Weight		Art. No
			HxW (mm)	HxW (in)	(kg)	(lb)	
S 8x1 AISI 316	1	240 x 120	298 x 141	11.732 x 5.551	3.9	8.620	S008000000121
S 8x2 AISI 316	2	240 x 120	298 x 271	11.732 x 10.669	6.1	13.382	S008000000221
S 8x3 AISI 316	3	240 x 120	298 x 402	11.732 x 15.827	8.2	18.144	S008000000321
S 8x4 AISI 316	4	240 x 120	298 x 532	11.732 x 20.945	10.4	22.928	S008000000421
S 8x5 AISI 316	5	240 x 120	298 x 663	11.732 x 26.102	12.6	27.690	S008000000521
S 8x6 AISI 316	6	240 x 120	298 x 793	11.732 x 31.220	14.7	32.452	S008000000621
S 8+8x1 AISI 316	2	240 x 120	586 x 141	23.071 x 5.551	7.3	16.005	S008800000121
S 8+8+8x1 AISI 316	3	240 x 120	874 x 141	34.409 x 5.551	9.9	21.826	S008880000121

S frame, aluminum



S 6x1 ALU

See parts needed for a complete solution on page 26.

See installation instructions on page 222.

See practical user guidelines on page 264.

For information about other frame combinations, or for openable versions of this frame, please contact your local Roxtec supplier or e-mail: info@roxtec.com

RATINGS

Fire: A class, H class

Water pressure: 4 bar

Gas pressure: 2.5 bar

Frame	Frame openings	Packing space (mm)	External dimensions (D=60 mm)		Weight		Art. No
			HxW (mm)	HxW (in)	(kg)	(lb)	
S 2x1 ALU	1	60 x 120	121 x 141	4.764 x 5.551	0.8	1.698	S002000000131
S 2x2 ALU	2	60 x 120	121 x 271	4.764 x 10.669	1.3	2.910	S002000000231
S 2x3 ALU	3	60 x 120	121 x 402	4.764 x 15.827	1.9	4.145	S002000000331
S 2x4 ALU	4	60 x 120	121 x 532	4.764 x 20.945	2.4	5.357	S002000000431
S 2x5 ALU	5	60 x 120	121 x 663	4.764 x 26.102	3.0	6.592	S002000000531
S 2x6 ALU	6	60 x 120	121 x 793	4.764 x 31.220	3.5	7.804	S002000000631
S 2+2x1 ALU	2	60 x 120	232 x 141	9.134 x 5.551	1.3	2.965	S002200000131
S 2+2+2x1 ALU	3	60 x 120	343 x 141	13.504 x 5.551	1.7	3.748	S002220000131
S 4x1 ALU	1	120 x 120	180 x 141	7.087 x 5.551	1.0	2.116	S004000000131
S 4x2 ALU	2	120 x 120	180 x 271	7.087 x 10.669	1.6	3.549	S004000000231
S 4x3 ALU	3	120 x 120	180 x 402	7.087 x 15.827	2.3	4.982	S004000000331

S frame, aluminum

Frame	Frame openings	Packing space (mm)	External dimensions (D=60 mm)		Weight		Art. No
			HxW (mm)	HxW (in)	(kg)	(lb)	
S 4x4 ALU	4	120 x 120	180 x 532	7.087 x 20.945	2.9	6.415	S004000000431
S 4x5 ALU	5	120 x 120	180 x 663	7.087 x 26.102	3.6	7.848	S004000000531
S 4x6 ALU	6	120 x 120	180 x 793	7.087 x 31.220	4.2	9.281	S004000000631
S 4+4x1 ALU	2	120 x 120	349 x 141	13.740 x 5.551	1.7	3.762	S004400000131
S 4+4x2 ALU	4	120 x 120	359 x 271	14.134 x 10.669	3.2	7.099	S004400000231
S 4+4x3 ALU	6	120 x 120	359 x 402	14.134 x 15.827	4.5	9.965	S004400000331
S 4+4x4 ALU	8	120 x 120	359 x 532	14.134 x 20.495	5.8	12.831	S004400000431
S 4+4+4x1 ALU	3	120 x 120	519 x 141	20.433 x 5.551	2.3	5.071	S004440000131
S 6x1 ALU	1	180 x 120	238 x 141	9.370 x 5.551	1.2	2.535	S006000000131
S 6x2 ALU	2	180 x 120	238 x 271	9.370 x 10.669	1.9	4.167	S006000000231
S 6x3 ALU	3	180 x 120	238 x 402	9.370 x 15.827	2.6	5.820	S006000000331
S 6x4 ALU	4	180 x 120	238 x 532	9.370 x 20.495	3.4	7.452	S006000000431
S 6x5 ALU	5	180 x 120	238 x 663	9.370 x 26.102	4.1	9.083	S006000000531
S 6x6 ALU	6	180 x 120	238 x 793	9.370 x 31.220	4.9	10.736	S006000000631
S 6+6x1 ALU	2	180 x 120	466 x 141	18.346 x 5.551	2.1	4.630	S006600000131
S 6+6x2 ALU	4	180 x 120	476 x 271	18.740 x 10.669	3.8	8.333	S006600000231
S 6+6x3 ALU	6	180 x 120	476 x 402	18.740 x 15.827	5.3	11.640	S006600000331
S 6+6x4 ALU	8	180 x 120	476 x 532	18.740 x 20.495	6.8	14.903	S006600000431
S 6+6x5 ALU	10	180 x 120	476 x 663	18.740 x 26.102	8.2	18.166	S006600000531
S 6+6x6 ALU	12	180 x 120	476 x 793	18.740 x 31.220	9.7	21.473	S006600000631
S 6+6+6x1 ALU	3	180 x 120	694 x 141	27.323 x 5.551	2.8	6.173	S006660000131
S 8x1 ALU	1	240 x 120	298 x 141	11.732 x 5.551	1.3	2.954	S008000000131
S 8x2 ALU	2	240 x 120	298 x 271	11.732 x 10.669	2.2	4.806	S008000000231
S 8x3 ALU	3	240 x 120	298 x 402	11.732 x 15.872	3.0	6.658	S008000000331
S 8x4 ALU	4	240 x 120	298 x 532	11.732 x 20.495	3.9	8.532	S008000000431
S 8x5 ALU	5	240 x 120	298 x 663	11.732 x 26.102	4.7	10.385	S008000000531
S 8x6 ALU	6	240 x 120	298 x 793	11.732 x 31.220	5.6	12.236	S008000000631
S 8+8x1 ALU	2	240 x 120	586 x 141	23.071 x 5.551	2.5	5.467	S008800000131
S 8+8+8x1 ALU	3	240 x 120	874 x 141	34.409 x 5.551	3.4	7.496	S008880000131

S frame, technical information

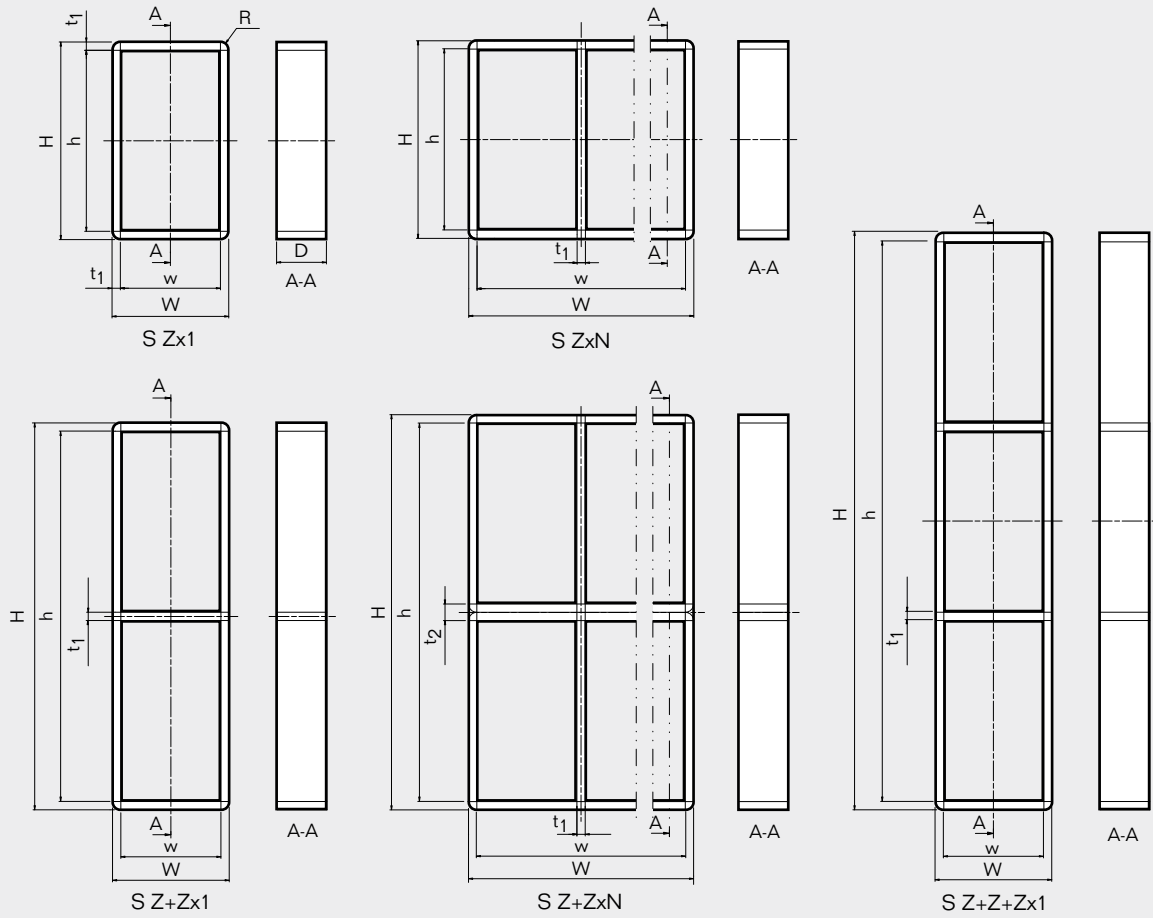

Pos	(mm)	(in)
h	H - 20	H - 0.787
w	W - 20	W - 0.787
D	60	2.362
t ₁	10	0.394
t ₂	20	0.787
R	R 10	R 0.394

Z = Frame size
 N = Number of horizontal openings

Note: All dimensions are nominal values

Plastic pipe solutions

An increasing trend within the marine industry to use plastic pipe has led us to develop a significant portfolio of products to protect and seal plastic pipe penetrations.



The Roxtec plastic pipe seals are available in a wide range of types and sizes. Seals can be fitted for circular or rectangular openings for either single or multiple plastic pipe penetrations.

Reducing the risk

Plastic pipe penetration seals require an additional level of protection. In the event of a fire onboard a marine vessel, the plastic pipe will quickly soften, melt and disappear, thus leaving a hole in the deck or bulkhead through which the fire can escape and spread into the next compartment. Therefore, the Roxtec pipe sealing solutions need to react during the fire in order to plug or block the hole created by the disappearing plastic pipe to reduce the risk of a fire spreading.

The Roxtec Sleeve-it™ solutions and the Roxtec R and RS PPS series contain a mix of intumescent based material. When exposed to the high temperatures of a fire, it reacts by expanding many times its volume. This creates a pressure inside and crushes the softening plastic pipe to form a plug of material which blocks the opening to stop the fire and smoke from spreading into the next compartment. In areas where higher watertight demands are required, we recommend pipe sealing options that incorporate Multidiameter™. In areas where watertight requirements do not exist or are lower,

such as within some installations above the waterline, we recommend the Roxtec Sleeve-it™ range. When the watertight integrity has to be maintained even after the fire, we can also offer a back-to-back solution (see page 188). Roxtec solutions for plastic pipes facilitate the decisions of ship owners and shipbuilders to use plastic pipe which may lead to lighter vessels, lower fuel costs, less corrosion issues and reduced maintenance costs. Roxtec seals do not only ensure safety, they also contribute to holding down the total cost of ownership.

- Flexible solutions
- Solution choices to fit applicable requirements
- Single or multiple plastic pipe penetrations
- Certified protection for various types of plastic pipe
- Single-side installation
- Certified fire, water and gas protection

How it works

The example shows the RS PPS/S in action. The functionality of the other Roxtec plastic pipe solutions is fundamentally the same.

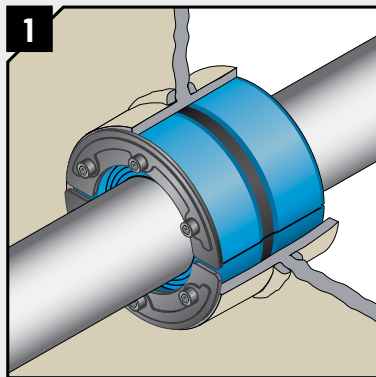

1 The Roxtec RS PPS/S seals the plastic pipe against leakage of water and gas through the steel division. Inside the seal, there is an intumescent based material.

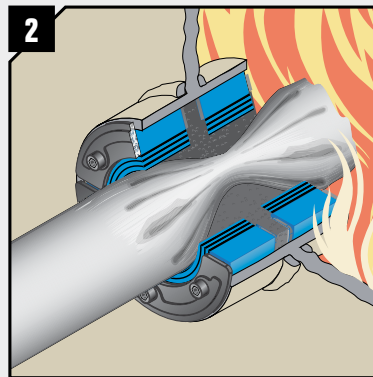

2 This material will expand and close the middle void of the pipe whenever exposed to high temperatures, such as during a fire.

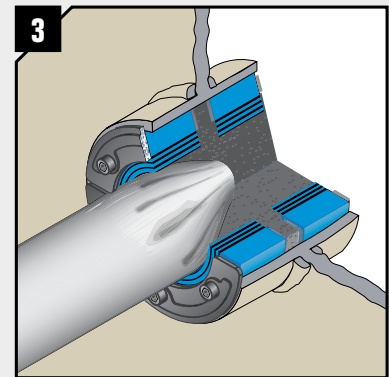

3 Should a fire occur and the plastic pipe start to burn and melt, the opening will close completely to prevent fire and smoke from spreading through the bulkhead or deck.



Roxtec RS PPS/S, single-side seal

The Roxtec RS PPS/S seal is a circular solution which protects single plastic pipe penetrations. It consists of two halves and an adaptable center with Multidiameter™ (removable layers for adaptability to pipes of different sizes). The two halves are simply inserted into a sleeve and the compression unit inside the seal is tightened in order to correctly protect the plastic pipe. Inside each half, a layer of intumescent based material is placed which reacts with the heat of a fire to protect the penetration once the plastic pipe begins to soften. This solution is installed from only one side of the deck or bulkhead.

- Approved for single-side installation
- Certified protection for various types of plastic pipe
- Single plastic pipe penetrations
- Multiple pipe dimensions covered by one product size
- Certified fire, water and gas protection

RS PPS/S seal, acid-proof stainless steel fittings



RS PPS/S 31
AISI 316



RS PPS/S 43
AISI 316



RS PPS/S 50
AISI 316



RS PPS/S 68
AISI 316



RS PPS/S 75
AISI 316

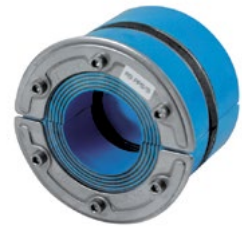

RS PPS/S 100
AISI 316 woc

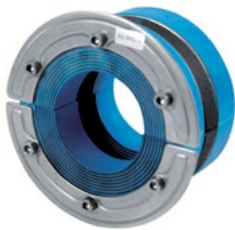

RS PPS/S 125
AISI 316 woc



RS PPS/S 150
AISI 316 woc

See sleeves on page 174.

See installation instructions on page 239.

RS PPS/S seal, acid-proof stainless steel fittings

RATINGS Fire: A class Water pressure: 4 bar Gas pressure: 2 bar

Seal	For pipe Ø		For hole Ø		Weight		Art. No
	(mm)	(in)	(mm)	(in)	(kg)	(lb)	
WITH CORE							
RS PPS/S 31 AISI 316	0+ 4-17	0+ 0.157-0.669	31-32	1.221-1.260	0.065	0.143	PPSS000003121
RS PPS/S 43 AISI 316	0+ 4-23	0+ 0.157-0.906	43-45	1.693-1.772	0.251	0.553	PPSS000004321
RS PPS/S 50 AISI 316	0+ 8-30	0+ 0.315-1.181	50-52	1.967-2.047	0.300	0.661	PPSS000005021
RS PPS/S 68 AISI 316	0+ 26-48	0+ 1.024-1.890	68-70	2.677-2.756	0.490	1.080	PPSS000006821
RS PPS/S 75 AISI 316	0+ 24-54	0+ 0.945-2.126	75-77	2.953-3.031	0.606	1.336	PPSS000007521
WITHOUT CORE							
RS PPS/S 100 AISI 316 woc	48-70	1.890-2.756	100-102	3.937-4.016	0.939	2.070	PPSS000010021
RS PPS/S 125 AISI 316 woc	66-98	2.598-3.858	125-127	4.921-5.000	1.306	2.879	PPSS000012521
RS PPS/S 150 AISI 316 woc	93-119	3.661-4.685	150-152	5.906-5.984	1.649	3.635	PPSS000015021

RS PPS/S seal, technical information

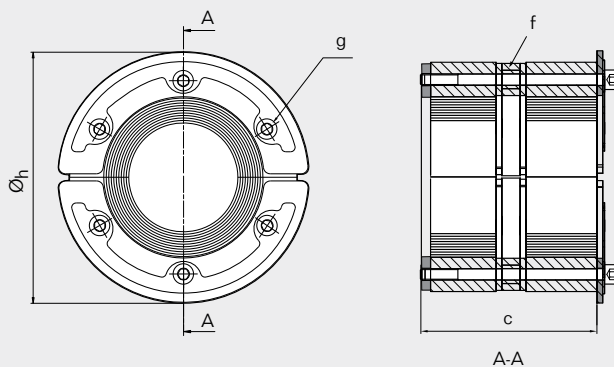

(f) Intumescent material

- * SW2.5 mm (4x) / SW0.098" (4x)
- ** SW4 mm (4x) / SW0.157" (4x)
- *** SW4 mm (6x) / SW0.157" (6x)
- **** SW5 mm (6x) / SW0.197" (6x)
- ***** SW5 mm (8x) / SW0.197" (8x)

For dimensions, please see page 140.

	RS PPS/S 31		RS PPS/S 43	
Pos	(mm)	(in)	(mm)	(in)
c	40	1.575	78	3.071
g	*	*	**	**
Ø _h	37	1.457	53	2.087

	RS PPS/S 50		RS PPS/S 68	
Pos	(mm)	(in)	(mm)	(in)
c	78	3.071	78	3.071
g	**	**	**	**
Ø _h	60	2.362	78	3.071

	RS PPS/S 75		RS PPS/S 100 woc	
Pos	(mm)	(in)	(mm)	(in)
c	78	3.071	83	3.267
g	***	***	***	***
Ø _h	85	3.346	110	4.331

	RS PPS/S 125 woc		RS PPS/S 150 woc	
Pos	(mm)	(in)	(mm)	(in)
c	83	3.267	83	3.267
g	****	****	****	****
Ø _h	145	5.709	170	6.693

Note: All dimensions are nominal values

Sleeves without flange, for RS PPS/S seal



SLRS primed mild steel



SLRS acid-proof stainless steel



SLRS aluminum

See practical user guidelines on page 264.

Primed mild steel

Sleeve	External dimensions				Internal Ø		Weight		Art. No
	Ø (mm)	Ø (in)	L (mm)	L (in)	(mm)	(in)	(kg)	(lb)	
SLRS 31 primed	40	1.575	35	1.378	31.5	1.240	0.14	0.30	ASL1000310012
SLRS 43 primed	52	2.047	65	2.559	44	1.732	0.31	0.68	ASL1000430012
SLRS 50 primed	63	2.480	65	2.559	51	2.008	0.54	1.19	ASL1000500012
SLRS 68 primed	83	3.268	65	2.559	69.5	2.736	0.81	1.79	ASL1000680012
SLRS 75 primed	89	3.504	65	2.559	76.5	3.012	0.83	1.83	ASL1000750012
SLRS 100 primed	114	4.488	65	2.559	101	3.976	1.10	2.43	ASL1001000012
SLRS 125 primed	140	5.512	65	2.559	126	4.961	1.50	3.31	ASL1001250012
SLRS 150 primed	164	6.457	65	2.559	151	5.945	1.63	3.58	ASL1001500012

Acid-proof stainless steel

Sleeve	External dimensions				Internal Ø		Weight		Art. No
	Ø (mm)	Ø (in)	L (mm)	L (in)	(mm)	(in)	(kg)	(lb)	
SLRS 31 AISI 316	40	1.575	35	1.378	31.5	1.240	0.14	0.30	ASL1000310021
SLRS 43 AISI 316	52	2.047	65	2.559	44	1.732	0.31	0.67	ASL1000430021
SLRS 50 AISI 316	63	2.480	65	2.559	51	2.008	0.54	1.18	ASL1000500021
SLRS 68 AISI 316	83	3.268	65	2.559	69.5	2.736	0.83	1.83	ASL1000680021
SLRS 75 AISI 316	89	3.504	65	2.559	76.5	3.012	0.83	1.83	ASL1000750021
SLRS 100 AISI 316	114	4.488	65	2.559	101	3.976	1.13	2.49	ASL1001000021
SLRS 125 AISI 316	140	5.512	65	2.559	126	4.961	1.53	3.37	ASL1001250021
SLRS 150 AISI 316	164	6.457	65	2.559	151	5.945	1.63	3.59	ASL1001500021

Aluminum

Sleeve	External dimensions				Internal Ø		Weight		Art. No
	Ø (mm)	Ø (in)	L (mm)	L (in)	(mm)	(in)	(kg)	(lb)	
SLRS 31 Alu	40	1.575	35	1.378	31.5	1.240	0.03	0.07	5ASL000003374
SLRS 43 Alu	52	2.047	65	2.559	44	1.732	0.10	0.22	5ASL000006302
SLRS 50 Alu	63	2.480	65	2.559	51	2.008	0.09	0.20	5ASL000000663
SLRS 68 Alu	83	3.268	65	2.559	69.5	2.736	0.12	0.26	5ASL000000516
SLRS 75 Alu	89	3.504	65	2.559	76.5	3.012	0.27	0.60	5ASL000000517
SLRS 100 Alu	114	4.488	65	2.559	101	3.976	0.38	0.84	5ASL000001259
SLRS 125 Alu	140	5.512	65	2.559	126	4.961	0.51	1.12	5ASL000000421
SLRS 150 Alu	164	6.457	65	2.559	151	5.945	0.53	1.17	5ASL000000191

Sleeves with flange, for RS PPS/S seal



SLFRS primed mild steel



SLFRS galvanized mild steel



SLFRS aluminum

See practical user guidelines on page 264.

Primed mild steel

Sleeve	External flange Ø		External dimensions				Internal Ø		Weight		Art. No
	(mm)	(in)	Ø (mm)	Ø (in)	L (mm)	L (in)	(mm)	(in)	(kg)	(lb)	
SLFRS 31 primed	102	4.016	40	1.575	35	1.378	31.5	1.240	0.30	0.65	ASF1000310012
SLFRS 43 primed	110	4.331	52	2.047	65	2.559	44	1.732	0.50	1.10	ASF1000430012
SLFRS 50 primed	140	5.512	63	2.480	65	2.559	51	2.008	0.93	2.05	ASF1000500012
SLFRS 68 primed	155	6.102	83	3.268	65	2.559	69.5	2.736	1.23	2.72	ASF1000680012
SLFRS 75 primed	165	6.496	89	3.504	65	2.559	76.5	3.012	1.33	2.93	ASF1000750012
SLFRS 100 primed	195	7.677	114	4.488	65	2.559	101	3.976	1.76	3.87	ASF1001000012
SLFRS 125 primed	213	8.386	140	5.512	65	2.559	126	4.961	2.07	4.56	ASF1001250012
SLFRS 150 primed	236	9.291	164	6.457	65	2.559	151	5.945	2.34	5.16	ASF1001500012

Galvanized mild steel

Sleeve	External flange Ø		External dimensions				Internal Ø		Weight		Art. No
	(mm)	(in)	Ø (mm)	Ø (in)	L (mm)	L (in)	(mm)	(in)	(kg)	(lb)	
SLFRS 31 galv	102	4.016	40	1.575	35	1.378	31.5	1.240	0.31	0.68	ASF1000310015
SLFRS 43 galv	110	4.331	52	2.047	65	2.559	44	1.732	0.50	1.10	ASF1000430015
SLFRS 50 galv	140	5.512	63	2.480	65	2.559	51	2.008	0.96	2.11	ASF1000500015
SLFRS 68 galv	155	6.102	83	3.268	65	2.559	69.5	2.736	1.26	2.78	ASF1000680015
SLFRS 75 galv	165	6.496	89	3.504	65	2.559	76.5	3.012	1.35	2.97	ASF1000750015
SLFRS 100 galv	195	7.677	114	4.488	65	2.559	101	3.976	1.79	3.95	ASF1001000015
SLFRS 125 galv	213	8.386	140	5.512	65	2.559	126	4.961	2.13	4.70	ASF1001250015
SLFRS 150 galv	236	9.291	164	6.457	65	2.559	151	5.945	2.41	5.31	ASF1001500015

Aluminum

Sleeve	External flange Ø		External dimensions				Internal Ø		Weight		Art. No
	(mm)	(in)	Ø (mm)	Ø (in)	L (mm)	L (in)	(mm)	(in)	(kg)	(lb)	
SLFRS 31 Alu	102	4.016	102	4.016	35	1.378	31.5	1.240	0.55	1.21	5ASF000002399
SLFRS 43 Alu	110	4.331	110	4.331	65	2.559	44	1.732	0.18	0.40	5ASF000002197
SLFRS 50 Alu	140	5.512	140	5.512	65	2.559	51	2.008	0.31	0.68	5ASF000002198
SLFRS 68 Alu	155	6.102	155	6.102	65	2.559	69.5	2.736	0.40	0.88	5ASF000007125
SLFRS 75 Alu	165	6.496	165	6.496	65	2.559	76.5	3.012	0.43	0.95	5ASF000008716
SLFRS 100 Alu	195	7.677	195	7.677	65	2.559	101	3.976	0.40	0.88	5ASF000004042
SLFRS 125 Alu	213	8.386	213	8.386	65	2.559	126	4.961	0.60	1.32	5ASF000003956
SLFRS 150 Alu	236	9.291	236	9.291	65	2.559	151	5.945	0.80	1.76	5ASF000008717



Roxtec RS PPS back-to-back seal

The Roxtec RS PPS seal is a circular solution which protects single plastic pipe penetrations. The solution comes as a kit and consists of two RS seals and one intumescent based sealing strip that wraps around the plastic pipe, in between the two RS seals. Each RS seal has two halves and an adaptable center with Multidiameter™ (removable layers for adaptability to pipes of different sizes). The two halves are simply inserted into each side of the sleeve and the compression units inside the seals are tightened to correctly protect the plastic pipe. Unlike most Roxtec sealing solutions, the RS PPS seal has to be installed on both sides of the division.

- Intended for use with SL PPS sleeves
- Certified protection for various types of plastic pipe
- Multiple pipe dimensions covered by one product size
- Single plastic pipe penetrations
- Certified fire, water and gas protection

RS PPS seal, acid-proof stainless steel fittings



RS PPS 31 AISI 316



RS PPS 43 AISI 316



RS PPS 50 AISI 316



RS PPS 68 AISI 316



RS PPS 75 AISI 316



RS PPS 100 AISI 316 woc



RS PPS 125 AISI 316 woc



RS PPS 150 AISI 316 woc



RS PPS 175-200 AISI 316 woc



RS PPS 225-400 AISI 316 woc

See sleeves on page 179.

See installation instructions on page 237.

RS PPS seal, acid-proof stainless steel fittings

RATINGS Fire: A class Water pressure: 4 bar Gas pressure: 2.5 bar

Seal	For pipe Ø		For hole Ø		Weight		Art. No
	(mm)	(in)	(mm)	(in)	(kg)	(lb)	
WITH CORE							
RS PPS 31 AISI 316	0+ 4-17	0+ 0.157-0.669	31.5-32.0	1.240-1.260	0.2	0.353	PPS0000031021
RS PPS 43 AISI 316	0+ 4-23	0+ 0.157-0.906	43.5-44.0	1.713-1.732	0.4	0.816	PPS0000043021
RS PPS 50 AISI 316	0+ 8-30	0+ 0.315-1.181	50.5-51.0	1.988-2.008	0.5	1.102	PPS0000050021
RS PPS 68 AISI 316	0+ 26-48	0+ 1.024-1.890	69.0-70.0	2.717-2.756	0.8	1.676	PPS0000068021
RS PPS 75 AISI 316	0+ 24-54	0+ 0.945-2.126	75-77	2.953-3.031	0.9	1.962	PPS0000075021
WITHOUT CORE							
RS PPS 100 AISI 316 woc	48-70	1.890-2.756	100-102	3.976-4.016	1.3	2.866	PPS0000100021
RS PPS 125 AISI 316 woc	66-98	2.598-3.858	125-127	4.964-5.000	1.9	4.189	PPS0000125021
RS PPS 150 AISI 316 woc	93-119	3.661-4.331	150-152	5.945-5.984	2.6	5.732	PPS0000150021
RS PPS 175 AISI 316 woc	119-147	4.685-5.787	175-177	6.929-6.968	3.8	8.378	PPS0000175021
RS PPS 200 AISI 316 woc	138-170	5.433-6.693	200-202	7.913-7.953	7.2	15.873	PPS0000200021
RS PPS 225 AISI 316 woc	151-181	5.945-7.126	225-228	8.858-8.976	6.4	14.11	PPS0000225021
RS PPS 250 AISI 316 woc	176-206	6.929-8.110	250-253	9.843-9.961	6.8	14.991	PPS0000250021
RS PPS 300 AISI 316 woc	206-236	8.110-9.291	300-303	11.811-11.929	11.6	25.574	PPS0000300021
RS PPS 350 AISI 316 woc	244-286	9.606-11.260	350-353	13.780-13.898	14.8	32.628	PPS0000350021
RS PPS 400 AISI 316 woc	294-336	11.575-13.228	400-403	15.748-15.866	18	39.683	PPS0000400021

RS PPS seal, technical information

RS PPS 31 / RS PPS 43 / RS PPS 50 / RS PPS 68 / RS PPS 75

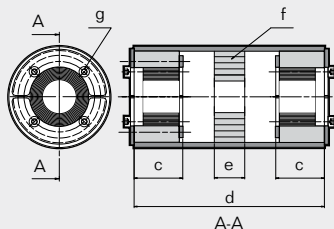

(f) Intumescent material

Pos	RS PPS 31		RS PPS 43		RS PPS 50		RS PPS 68		RS PPS 75	
	(mm)	(in)	(mm)	(in)	(mm)	(in)	(mm)	(in)	(mm)	(in)
c	40	1.575	40	1.575	40	1.575	40	1.575	40	1.575
d	156	6.142	156	6.142	156	6.142	156	6.142	156	6.142
e	25	0.984	25	0.984	25	0.984	25	0.984	25	0.984
g	*	*	**	**	**	**	**	**	***	***

* SW2.5 mm (4x) / SW0.098" (4x) ** SW4 mm (4x) / SW0.157" (4x)

*** SW4 mm (6x) / SW0.157" (6x)

RS PPS 100 woc / RS PPS 125 woc / RS PPS 150 woc

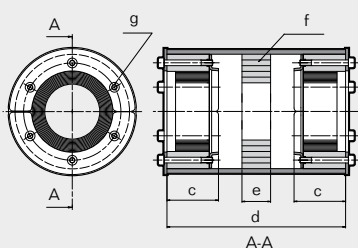

Pos	RS PPS 100 woc		RS PPS 125 woc		RS PPS 150 woc	
	(mm)	(in)	(mm)	(in)	(mm)	(in)
c	45	1.772	45	1.772	45	1.772
d	156	6.142	156	6.142	156	6.142
e	25	0.984	25	0.984	25	0.984
g	***	***	****	****	*****	*****

*** SW4 mm (6x) / SW0.157" (6x) **** SW5 mm (6x) / SW0.197" (8x)

***** SW5 mm (8x) / SW0.197" (8x)

RS PPS 175 woc / RS PPS 200 woc

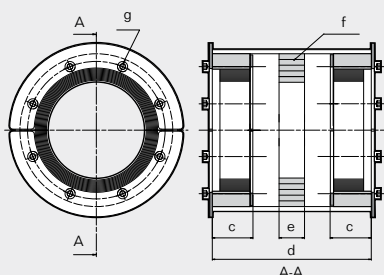

Pos	RS PPS 175 woc		RS PPS 200 woc	
	(mm)	(in)	(mm)	(in)
c	35	1.378	35	1.378
d	156	6.142	156	6.142
e	25	0.984	25	0.984
g	*****	*****	*****	*****

***** SW5 mm (8x) / SW0.197" (8x)

RS PPS 225 woc / RS PPS 250 woc / RS PPS 300 woc / RS PPS 350 woc / RS PPS 400 woc

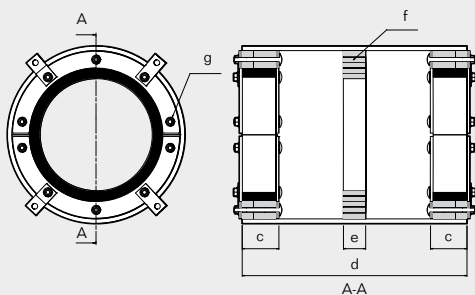

Pos	RS PPS 225		RS PPS 250		RS PPS 300		RS PPS 350		RS PPS 400	
	(mm)	(in)	(mm)	(in)	(mm)	(in)	(mm)	(in)	(mm)	(in)
c	65	2.559	65	2.559	65	2.559	65	2.559	65	2.559
d	400	15.748	400	15.748	400	15.748	400	15.748	400	15.748
e	25	0.984	25	0.984	25	0.984	25	0.984	25	0.984
g	**	**	**	**	***	***	***	***	***	***

** SW 10 mm (10x) / SW 0.394" (10x)

*** SW 13 mm (10x) / SW 0.512" (10x)

For dimensions, please see page 140.

Note: All dimensions are nominal values

Sleeves without flange, for RS PPS seal, primed mild steel



SLPPS primed



SLPPS aluminum

See practical user guidelines on page 264.

Primed mild steel

Sleeve	External dimensions				Internal Ø		Weight		Art. No
	Ø (mm)	Ø (in)	L (mm)	L (in)	(mm)	(in)	(kg)	(lb)	
SLPPS 31 PRIMED D=156	40	1.575	156	6.142	31.5	1.24	0.55	1.22	5ASL000005820
SLPPS 43 PRIMED D=156	52	2.047	156	6.142	44	1.73	0.74	1.63	5ASL000005500
SLPPS 50 PRIMED D=156	63	2.480	156	6.142	51	2.01	1.32	2.90	5ASL000003416
SLPPS 68 PRIMED D=156	83	3.268	156	6.142	69.5	2.74	2.05	4.51	5ASL000004742
SLPPS 75 PRIMED D=156	89	3.504	156	6.142	76.5	3.01	2.02	4.45	5ASL000003445
SLPPS 100 PRIMED D=156	114	4.488	156	6.142	101	3.98	2.69	5.93	5ASL000003519
SLPPS 125 PRIMED D=156	140	5.512	156	6.142	126	4.96	3.58	7.90	5ASL000003446
SLPPS 150 PRIMED D=156	164	6.457	156	6.142	151	5.94	3.94	8.68	5ASL000003417
SLPPS 175 PRIMED D=156	189	7.441	156	6.142	176	6.93	4.56	10.06	5ASL000003769
SLPPS 200 PRIMED D=156	214	8.425	156	6.142	201.5	7.93	5.00	11.01	5ASL000005458
SLPPS 225 PRIMED D=400	239	9.409	400	15.748	227	8.94	13.79	30.40	5ASL000011648
SLPPS 250 PRIMED D=400	264	10.394	400	15.748	252	9.921	15.27	33.66	5ASL000010621
SLPPS 300 PRIMED D=400	314	12.362	400	15.748	302	11.890	18.23	40.19	5SLPPS0011514
SLPPS 350 PRIMED D=400	364	14.331	400	15.748	352	13.858	21.19	46.71	109368
SLPPS 400 PRIMED D=400	414	16.299	400	15.748	402	15.827	24.15	53.24	105698

Aluminum

Sleeve	External dimensions				Internal Ø		Weight		Art. No
	Ø (mm)	Ø (in)	L (mm)	L (in)	(mm)	(in)	(kg)	(lb)	
SLPPS 31 Alu D=156	40	1.575	156	6.142	31.5	1.24	0.19	0.419	109365
SLPPS 43 Alu D=156	52	2.047	156	6.142	44	1.73	0.23	0.507	5ASL000011395
SLPPS 50 Alu D=156	63	2.480	156	6.142	51	2.01	0.45	0.992	119603
SLPPS 68 Alu D=156	83	3.268	156	6.142	69.5	2.74	0.69	1.521	119604
SLPPS 75 Alu D=156	89	3.504	156	6.142	76.5	3.01	0.7	1.543	ASL0156007531
SLPPS 100 Alu D=156	114	4.488	156	6.142	101	3.98	0.85	1.874	5ASL000008932
SLPPS 125 Alu D=156	140	5.512	156	6.142	126	4.96	1.13	2.49	5ATS000009641
SLPPS 150 Alu D=156	164	6.457	156	6.142	151	5.94	1.24	2.734	5ASL000009835
SLPPS 175 Alu D=156	189	7.441	156	6.142	176	6.929	1.55	3.417	119601
SLPPS 200 Alu D=156	214	8.425	156	6.142	201	7.913	1.58	3.483	5ASL000012395



Roxtec SE PPS extension frame

The Roxtec SE PPS extension frame is an accessory which in conjunction with a standard Roxtec S/SF frame protects installations of several plastic pipe penetrations against the risk of fire. The solution includes a layer of intumescent based material which reacts with the heat of a fire to protect the penetration once the plastic pipe begins to soften.

- Single-side installation
- Certified protection for various types of plastic pipe
- Multiple pipe penetrations included within one opening in the deck or bulkhead
- Certified fire, water and gas protection
- Options to allow a mix of pipe materials (metal and plastic) and in some cases, even cables within the same opening

SE PPS extension frame, galvanized



SE PPS 6x1 galv

See parts needed for a complete solution on page 26.

See practical user guidelines on page 264.

Installation instructions are available on www.roxtec.com

For information about other frame combinations, please contact your local Roxtec supplier or e-mail: info@roxtec.com

Frame	External dimensions (D=100 mm)		Weight		Art. No
	HxW (mm)	HxW (in)	(kg)	(lb)	
SE PPS 2x1 galv	195 x 215	7.677 x 8.465	0.8	1.653	5PPSE00003323
SE PPS 2x2 galv	195 x 345	7.677 x 13.583	1.2	2.668	5PPSE00003324
SE PPS 2x3 galv	195 x 476	7.677 x 18.740	1.7	3.704	5PPSE00005088
SE PPS 2x4 galv	195 x 606	7.677 x 23.858	2.7	4.718	5PPSE00005089
SE PPS 3x1 galv	254 x 155	9.999 x 6.102	0.7	1.543	5PPSE00003320
SE PPS 4x1 galv	254 x 215	9.999 x 8.465	0.9	1.984	5PPSE00003325
SE PPS 4x2 galv	254 x 345	9.999 x 13.583	1.5	3.197	5PPSE00003326

SE PPS extension frame, galvanized

Frame	External dimensions (D=100 mm)		Weight		Art. No
	HxW (mm)	HxW (in)	(kg)	(lb)	
SE PPS 4x3 galv	254 x 476	9.999 x 18.740	2.0	4.431	5PPSE00003327
SE PPS 4x4 galv	254 x 606	9.999 x 23.858	2.6	5.644	5PPSE00005090
SE PPS 5x1 galv	312 x 155	12.283 x 6.102	1.0	2.094	5PPSE00003321
SE PPS 6x1 galv	312 x 215	12.283 x 8.465	1.1	2.315	5PPSE00003328
SE PPS 6x2 galv	312 x 345	12.283 x 13.583	1.7	3.748	5PPSE00003329
SE PPS 6x3 galv	312 x 476	12.283 x 18.740	2.4	5.181	5PPSE00003330
SE PPS 6x4 galv	312 x 606	12.283 x 23.858	3.0	6.614	5PPSE00003331

SE PPS extension frame, technical information

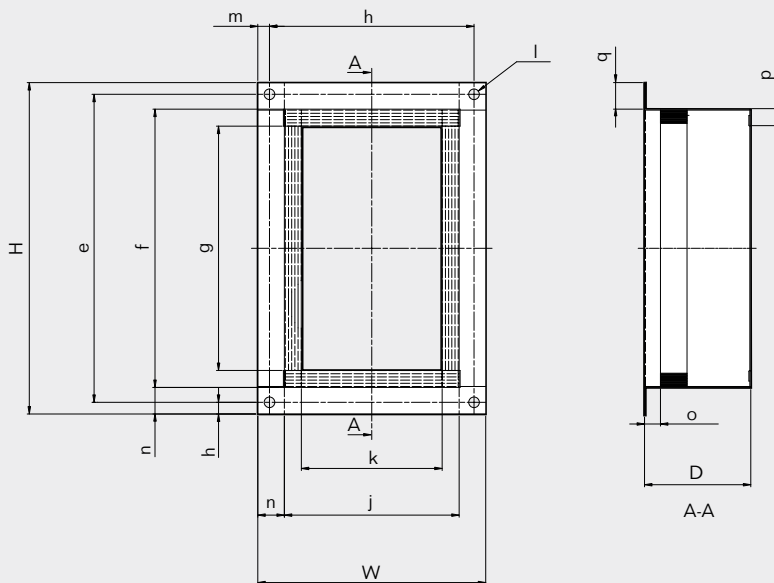

Pos	(mm)	(in)
e	H-22	H-0.866
f	H-50	H-1.968
g	H-82	3.228
h	W-22	H-0.866
j	W-50	H-1.968
k	W-82	3.228
l	Ø 10 (4x)	Ø 0.394 (4x)
m	11	1.969
n	25	0.984
o	15	0.591
p	16	0.630
q	25	0.984
D	100	3.937

	(mm)	(in)
Thickness steel sheet	0.9	0.035

Note: All dimensions are nominal values

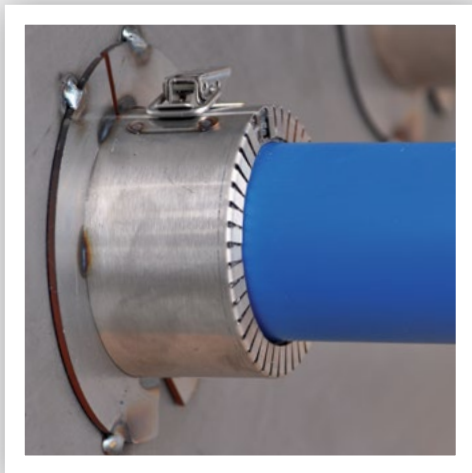

Roxeltec Sleeve-it™ Fire penetration seal

The Roxeltec Sleeve-it Fire penetration seal is a circular solution which protects single plastic pipe penetrations against fire hazards. The solution requires no sleeve to be installed and its stainless steel casing contains layers of intumescent based material that react with the heat of a fire to protect the penetration once the plastic pipe begins to soften. The light weight and ease of installation benefits of this product make it an ideal solution when used in fire only rated divisions.

- Single-side installation
- Minimal hot work onboard as it only requires tack welding into place
- Certified protection for various types of plastic pipe
- Quick and easy to install
- The openable aspect benefits retrofit as well as new-build projects

Roxeltec Sleeve-it™ Fire penetration seal, mild steel/stainless steel



Sleeve-it FC-MAR 16-40



Sleeve-it FC-MAR 50-225

See installation instructions on page 245.

RATINGS Fire: A class, B class

Seal	For pipe Ø		Aperture dim. ± 4 mm (0.157")		Weight		Art. No
	(mm)	(in)	Ø (mm)	Ø (in)	(kg)	(lb)	
Sleeve-it FC - MAR16M	16	0.63	22	0.866	0.09	0.198	106239
Sleeve-it FC - MAR20M	20	0.787	26	1.024	0.13	0.287	106245
Sleeve-it FC - MAR25M	25	0.984	31	1.220	0.15	0.331	106247
Sleeve-it FC - MAR32M	32	1.26	38	1.496	0.17	0.375	106249

Roxtec Sleeve-it™ Fire penetration seal, mild steel/stainless steel

Seal	For pipe Ø		Aperture dim. ± 4 mm (0.157")		Weight		Art. No
	(mm)	(in)	Ø (mm)	Ø (in)	(kg)	(lb)	
Sleeve-it FC - MAR40M	40	1.575	46	1.811	0.2	0.441	106251
Sleeve-it FC - MAR50M (1.5")	48.3	1.902	54	2.126	0.36	0.794	106253
Sleeve-it FC - MAR60M (2")	60.3	2.374	66	2.598	0.4	0.882	106255
Sleeve-it FC - MAR63M	63	2.480	69	2.717	0.41	0.904	106257
Sleeve-it FC - MAR66M	66	2.598	72	2.835	0.5	1.102	117916
Sleeve-it FC - MAR75M	75	2.953	81	3.189	0.55	1.213	106259
Sleeve-it FC - MAR82M	82	3.228	88	3.465	0.6	1.323	117919
Sleeve-it FC - MAR90M (3")	88.9	3.5	95	3.740	0.67	1.477	106261
Sleeve-it FC - MAR110M	110	4.331	116	4.567	0.83	1.830	106263
Sleeve-it FC - MAR115M (4")	114.3	4.5	120	4.724	0.83	1.830	106265
Sleeve-it FC - MAR125M	125	4.921	131	5.157	0.91	2.006	106267
Sleeve-it FC - MAR140M	140	5.512	146	5.748	1.05	2.315	106269
Sleeve-it FC - MAR160M	160	6.3	166	6.535	1.3	2.866	106271
Sleeve-it FC - MAR169M (6")	168.3	6.63	174	6.850	1.37	3.020	106273
Sleeve-it FC - MAR200M	200	7.87	206	8.110	1.86	4.100	106275
Sleeve-it FC - MAR219M (8")	219.1	8.63	225	8.858	1.95	4.299	106278
Sleeve-it FC - MAR225M	225	8.86	231	9.094	2.07	4.563	106280

Fire penetration seals to protect pipe sizes larger than 225 mm and up to 324 mm are available on request.

Roxtec Sleeve-it™ Fire penetration seal, technical information

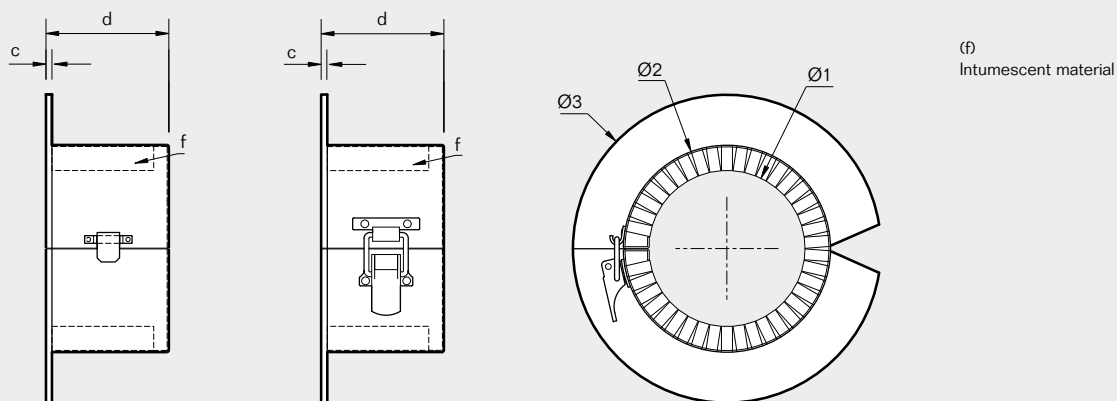

Tab fixing
(≤ 40 mm/1.575")

Toggle fixing
(≥ 50 mm/1.902")

	Sleeve-it FC - MAR16M		Sleeve-it FC - MAR20M		Sleeve-it FC - MAR25M		Sleeve-it FC - MAR32M		Sleeve-it FC - MAR40M		Sleeve-it FC - MAR50M (1.5")		Sleeve-it FC - MAR60M (2")	
Pos	(mm)	(in)	(mm)	(in)	(mm)	(in)	(mm)	(in)	(mm)	(in)	(mm)	(in)	(mm)	(in)
c	3	0.118	3	0.118	3	0.118	3	0.118	3	0.118	3	0.118	3	0.118
d	60	2.362	60	2.362	60	2.362	60	2.362	60	2.362	61	2.402	61	2.402
Ø1	16	0.63	20	0.787	25	0.984	32	1.26	40	1.575	48.3	1.902	60.3	2.374
Ø2	28	1.102	36	1.417	41	1.614	48	1.890	56	2.205	69	2.717	81	3.189
Ø3	58	2.283	66	2.598	71	2.795	78	3.071	86	3.386	119	4.685	131	5.157

	Sleeve-it FC - MAR63M		Sleeve-it FC - MAR66M		Sleeve-it FC - MAR75M		Sleeve-it FC - MAR82M		Sleeve-it FC - MAR90M (3")		Sleeve-it FC - MAR110M		Sleeve-it FC - MAR115M (4")	
Pos	(mm)	(in)	(mm)	(in)	(mm)	(in)	(mm)	(in)	(mm)	(in)	(mm)	(in)	(mm)	(in)
c	3	0.118	3	0.118	3	0.118	3	0.118	3	0.118	3	0.118	3	0.118
d	61	2.402	61	2.402	61	2.402	61	2.402	61	2.402	61	2.402	61	2.402
Ø1	63	2.48	66	2.598	75	2.953	82	3.228	88.9	3.5	110	4.331	114.3	4.5
Ø2	84	3.307	94	3.701	103	4.055	106	4.173	122	4.803	143	5.630	142	5.591
Ø3	133	5.236	144	5.669	153	6.024	156	6.142	172	6.772	193	7.598	192	7.559

	Sleeve-it FC - MAR125M		Sleeve-it FC - MAR140M		Sleeve-it FC - MAR160M		Sleeve-it FC - MAR169M (6")		Sleeve-it FC - MAR200M		Sleeve-it FC - MAR219M (8")		Sleeve-it FC - MAR225M	
Pos	(mm)	(in)	(mm)	(in)	(mm)	(in)	(mm)	(in)	(mm)	(in)	(mm)	(in)	(mm)	(in)
c	3	0.118	3	0.118	3	0.118	3	0.118	3	0.118	3	0.118	3	0.118
d	61	2.402	61	2.402	61	2.402	61	2.402	61	2.402	61	2.402	61	2.402
Ø1	125	4.921	140	5.512	160	6.3	168.3	6.63	200	7.87	219.1	8.63	225	8.86
Ø2	158	6.220	176	6.929	204	8.031	213	8.386	240	9.449	280	11.024	277	10.906
Ø3	206	8.110	225	8.858	253	9.961	253	9.961	290	11.417	330	12.992	326	12.835

Note: All dimensions are nominal values

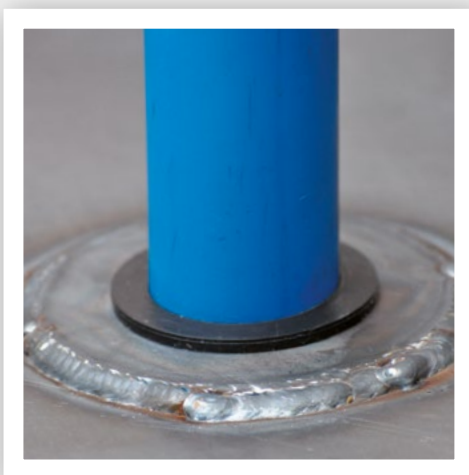

Roxtec Sleeve-it™ Waterproof penetration seal

The Roxtec Sleeve-it Waterproof penetration seal is a circular solution which protects single plastic pipe penetrations against the risks of fire and water. Its stainless steel casing contains layers of intumescent based material that react with the heat of a fire to protect the penetration once the plastic pipe begins to soften. The specifically engineered rubber grommet is sized per specific pipe size in both metric and imperial sizes and designed to maintain a waterproof seal round the plastic pipe.

- Single-side installation benefits
- Certified protection for various types of plastic pipe
- Quick and easy to install
- Certified to 1 bar of water pressure
- Not to be used in high pressure watertight divisions

Roxtec Sleeve-it™ Waterproof penetration seal, mild steel/stainless steel



Sleeve-it WT-MAR 16-40



Sleeve-it WT-MAR 50-225



Sleeve-it WT-MAR INCH 1.5-8"

See installation instructions on page 249.

RATINGS Fire: A class, B class Water pressure: 1 bar

Seal	For pipe Ø		Aperture dim. ± 5 mm (0.197")		Weight		Art. No
	(mm)	(in)	Ø (mm)	Ø (in)	(kg)	(lb)	
Sleeve-it WT - MAR16M	16	0.63	41	1.614	0.25	0.551	106315
Sleeve-it WT - MAR20M	20	0.787	49	1.929	0.32	0.705	106316
Sleeve-it WT - MAR25M	25	0.984	51	2.008	0.34	0.750	106319
Sleeve-it WT - MAR32M	32	1.26	58	2.283	0.37	0.816	106322

Roxtec Sleeve-it™ Waterproof penetration seal, mild steel/stainless steel

Seal	For pipe Ø		Aperture dim. ± 5 mm (0.197")		Weight		Art. No
	(mm)	(in)	Ø (mm)	Ø (in)	(kg)	(lb)	
Sleeve-it WT - MAR40M	40	1.575	69	2.717	0.41	0.904	106325
Sleeve-it WT - MAR50M (1.5")	48,3	1.968	79	3.110	0.48	1.058	106359
Sleeve-it WT - MAR50M	50	1.902	79	3.110	0.47	1.036	106328
Sleeve-it WT - MAR60M (2")	60,3	2.374	90	3.543	0.52	1.146	106362
Sleeve-it WT - MAR63M	63	2.480	93	3.661	0.53	1.168	106331
Sleeve-it WT - MAR75M	75	2.953	112	4.409	0.72	1.587	106334
Sleeve-it WT - MAR90M (3")	88,9	3.49	134	5.276	0.98	2.160	106365
Sleeve-it WT - MAR90M	90	3.543	132	5.197	0.95	2.094	106337
Sleeve-it WT - MAR110M	110	4.49	153	6.024	1.2	2.646	106341
Sleeve-it WT - MAR115M (4")	114,3	4.331	152	5.984	1.16	2.557	106371
Sleeve-it WT - MAR125M	125	4.921	172	6.772	1.35	2.976	106344
Sleeve-it WT - MAR140M	140	5.512	180	7.087	1.5	3.307	106347
Sleeve-it WT - MAR160M	160	6.299	215	8.465	1.82	4.012	106350
Sleeve-it WT - MAR169M (6")	168,3	6.623	225	8.858	2	4.409	106373
Sleeve-it WT - MAR200M	200	7.874	250	9.843	2.6	5.732	106353
Sleeve-it WT - MAR219M (8")	219.1	8.626	286	11.260	3.5	7.716	106375
Sleeve-it WT - MAR225M	225	8.858	290	11.417	3.7	8.157	106356

Waterproof penetration seals to protect pipe sizes larger than 225 mm and up to 324 mm are available on request.

Roxtec Sleeve-it™ Waterproof penetration seal, technical information

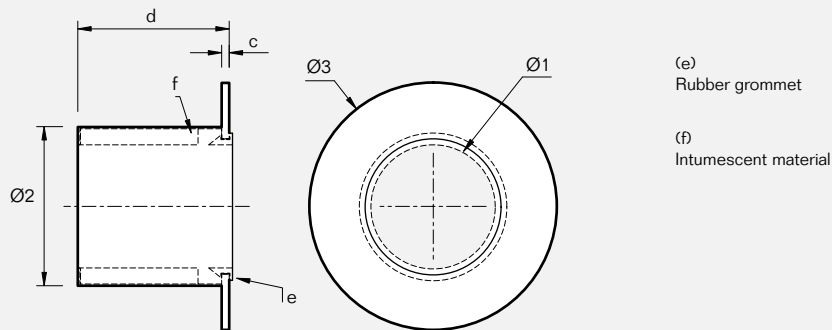

Pos	Sleeve-it WT - MAR16M		Sleeve-it WT - MAR20M		Sleeve-it WT - MAR25M		Sleeve-it WT - MAR32M		Sleeve-it WT - MAR40M		Sleeve-it WT - MAR50M (1.5") *		Sleeve-it WT - MAR50M	
	(mm)	(in)	(mm)	(in)	(mm)	(in)	(mm)	(in)	(mm)	(in)	(mm)	(in)	(mm)	(in)
c	5	0.197	5	0.197	5	0.197	5	0.197	5	0.197	5	0.197	5	0.197
d	75	2.953	75	2.953	75	2.953	75	2.953	70	2.756	70	2.756	70	2.756
Ø1	16	0.630	20	0.787	25	0.984	32	1.260	40	1.575	48.3	1.902	50	1.969
Ø2	31	1.220	39	1.535	44.5	1.614	48	1.890	59	2.323	69	2.717	69	2.717
Ø3	71	2.795	79	3.110	84	3.228	88	3.465	102	4.016	112	4.409	112	4.409

Pos	Sleeve-it WT - MAR60M (2") *		Sleeve-it WT - MAR63M		Sleeve-it WT - MAR75M		Sleeve-it WT - MAR90M (3") *		Sleeve-it WT - MAR90M		Sleeve-it WT - MAR110M		Sleeve-it WT - MAR115M (4") *	
	(mm)	(in)	(mm)	(in)	(mm)	(in)	(mm)	(in)	(mm)	(in)	(mm)	(in)	(mm)	(in)
c	5	0.197	5	0.197	5	0.197	5	0.197	5	0.197	5	0.197	5	0.197
d	70	2.756	70	2.756	70	2.756	70	2.756	70	2.756	70	2.756	70	2.756
Ø1	60.3	2.374	63	2.480	75	2.953	88.9	3.500	90	3.543	110	4.331	114.3	4.500
Ø2	80	3.150	83	3.268	102	4.016	124	4.882	122	4.803	143	5.630	142	5.591
Ø3	121	4.764	121	4.764	142	5.591	164	6.457	165	6.496	183	7.205	186	7.323

Pos	Sleeve-it WT - MAR125M		Sleeve-it WT - MAR140M		Sleeve-it WT - MAR160M		Sleeve-it WT - MAR169M (6") *		Sleeve-it WT - MAR200M		Sleeve-it WT - MAR219M (8") *		Sleeve-it WT - MAR225M	
	(mm)	(in)	(mm)	(in)	(mm)	(in)	(mm)	(in)	(mm)	(in)	(mm)	(in)	(mm)	(in)
c	5	0.197	5	0.197	5	0.197	5	0.197	5	0.197	5	0.197	5	0.197
d	70	2.756	70	2.756	70	2.756	70	2.756	70	2.756	70	2.756	70	2.756
Ø1	125	4.921	140	5.512	160	6.299	168.3	6.626	200	7.874	219.1	8.626	225	8.858
Ø2	162	6.378	170	6.693	205	8.071	215	8.465	240	9.449	276	10.866	280	11.024
Ø3	202	7.953	218	8.583	243	9.567	255	10.039	290	11.417	326	12.835	335	13.189

* Grommet in red color

Note: All dimensions are nominal values

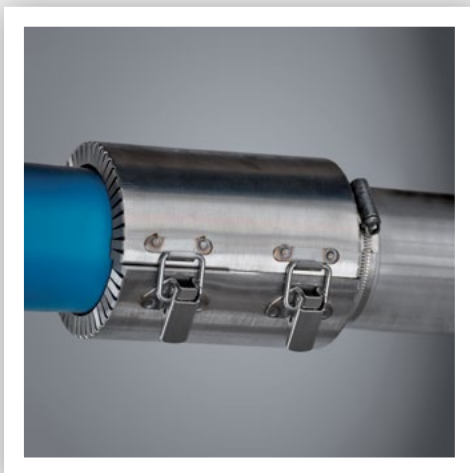

Rortex Sleeve-it™ Transition collar

The Rortex Sleeve-it Transition collar is a stainless steel casing that wraps around the joint between a steel and plastic pipe. The casing contains layers of intumescent based material that react with the heat of a fire to protect the transition once the plastic pipe begins to soften. The solution is not a coupling between the steel and plastic pipe.

- For steel and plastic pipe connections – not a coupling mechanism
- For use in non-pressurized systems
- Certified protection for various types of plastic pipe
- Quick and easy to install – a non-welding solution

Rortex Sleeve-it™ Transition collar, stainless steel



Sleeve-it TR-MAR

See installation instructions on page 251.

RATINGS Fire: A class

Transition type	Collar length - c		Collar - Ø3		Steel pipe opening - Ø1		Plastic pipe opening - Ø2		Weight		Art. no
	(mm)	(in)	(mm)	(in)	(mm)	(in)	(mm)	(in)	(kg)	(lb)	
Sleeve-it TR - MAR 50/50	138	5.433	73	2.874	50	1.968	53	2.087	0.46	1.014	106289
Sleeve-it TR - MAR - 50/60 - (2")	138	5.433	80	3.150	50	2.953	62	3.071	0.5	1.102	106304
Sleeve-it TR - MAR - 75/75	138	5.433	101	3.976	75	1.968	78	2.441	0.66	1.455	106298
Sleeve-it TR - MAR - 75/90 - (3")	138	5.433	115	4.528	75	2.953	92	3.622	0.72	1.587	106307
Sleeve-it TR - MAR - 90/90	138	5.433	118	4.646	90	3.543	92	3.622	0.72	1.587	106310

Roxtec Sleeve-it™ Transition collar, technical information

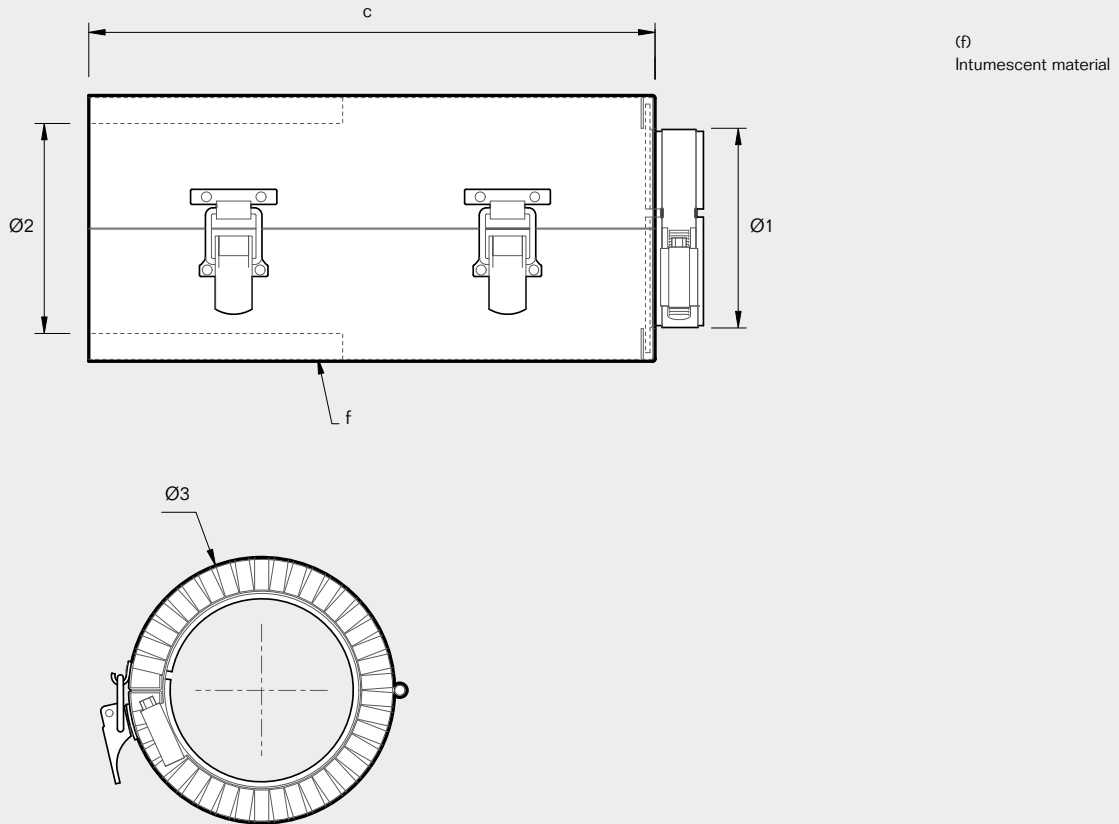

Note: All dimensions are nominal values

Water-tightness after fire solutions

We are continuously working to find sealing solutions for our customers. One example is our “back-to-back” arrangements that maintain watertight integrity after a fire.

Wording within the applicable SOLAS regulations refers to heat sensitive material penetrating bulkhead structures below the waterline, where deterioration of such materials in the case of fire may impair the watertight integ-

riety of the bulkhead. The wording specifically applies to watertight installations in SPS vessels and passenger ships for penetrations below the waterline. In order to comply with this regulation, Roxtec has conducted a series

of tests with “back-to-back” arrangements within an elongated sleeve. These tests have successfully maintained watertight integrity after a fire exposure has occurred.

How it works

The example shows the Roxtec RS PPS/S F+WT seal in action.

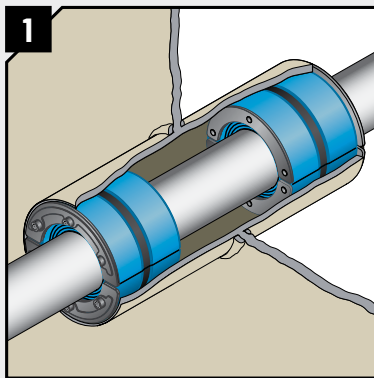

The Roxtec RS PPS/S F+WT sealing solution includes two RS PPS/S seals to provide a gas and watertight seal around the plastic pipe. Inside the seals we have a layer of intumescent based material designed to react during a fire.

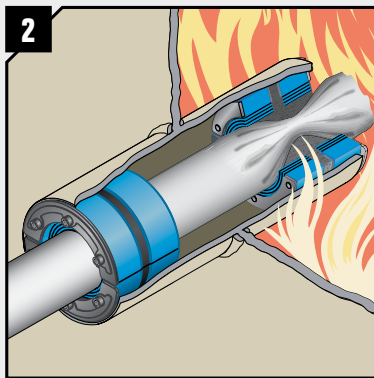

Whenever exposed to the high temperatures of a fire, the material inside the RS PPS/S seal on the fire side of the penetration will exfoliate and expand to crush the softening plastic pipe in order to prevent the fire and smoke from spreading through to the next compartment.

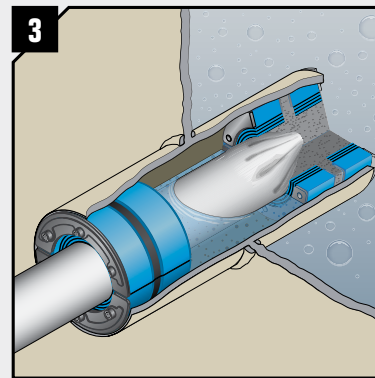

Should a second catastrophic event such as a flood take place, the intumescent based material will not maintain a watertight seal however, the RS PPS/S seal that was not affected by the fire, will maintain its gastight and watertight qualities which will protect the penetration in the division against water ingress.

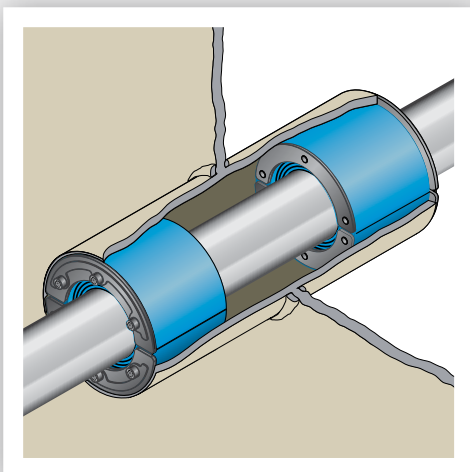

Roxtec RS F+WT

The Roxtec RS F+WT is a back-to-back sealing solution for openings with single metal pipe penetrations in bulkheads where there is a demand for water-tightness after fire. The kit consists of two RS seals providing protection against hazards caused by fire, gas and water. In case of fire, it efficiently blocks smoke and flames from passing through the penetration, and after a fire it still maintains watertight integrity.

- Double-sided installation inside an extended sleeve (length 312 mm)
- Certified protection for various types of metal pipes
- Single metal pipe penetrations
- Multiple pipe dimensions covered by one product size
- Certified fire, water and gas protection

RS F+WT kit, acid-proof stainless steel fittings



RS F+WT

See information and measurements for RS seal on page 138.

See sleeves on page 193.

See installation instructions for RS seal on page 233.

RATINGS Fire: A class Water pressure: 1.33 bar

Kit	For pipe Ø		For hole Ø		Weight		Art. No
	(mm)	(in)	(mm)	(in)	(kg)	(lb)	
WITH CORE							
RS F+WT 43 AISI 316	0+ 4-23	0+ 0.157-0.906	43-45	1.693-1.772	0.4	1.058	152046
RS F+WT 50 AISI 316	0+ 8-30	0+ 0.315-1.181	50-52	1.967-2.047	0.6	1.278	152047
RS F+WT 68 AISI 316	0+ 26-48	0+ 1.024-1.890	68-70	2.677-2.756	1	2.204	152048
RS F+WT 75 AISI 316	0+ 24-54	0+ 0.945-2.126	75-77	2.953-3.031	1.4	3.086	152049
RS F+WT 100 AISI 316	0+ 48-70	0+ 1.890-2.756	100-102	3.937-4.016	2	4.41	152050
RS F+WT 125 AISI 316	0+ 66-98	0+ 2.598-3.858	125-127	4.921-5.000	3.2	6.834	152051
WITHOUT CORE							
RS F+WT 100 AISI 316 woc	48-70	1.890-2.756	100-102	3.937-4.016	1.6	3.748	152052
RS F+WT 125 AISI 316 woc	66-98	2.598-3.858	125-127	4.921-5.000	2.4	5.512	152053
RS F+WT 150 AISI 316 woc	93-119	3.661-4.685	150-152	5.906-5.984	3.2	6.834	152054

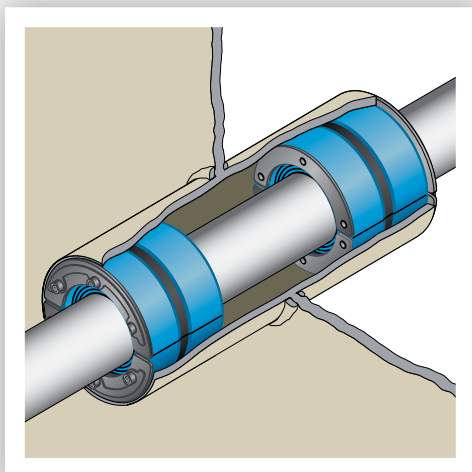

Roxtec RS PPS/S F+WT

The Roxtec RS PPS/S F+WT is a back-to-back sealing solution for openings with single plastic pipe penetrations in bulkheads where there is a demand for water-tightness after fire. The kit consists of two RS PPS/S seals providing protection against hazards caused by fire, gas and water. In case of fire, it efficiently blocks smoke and flames from passing through the penetration, and after a fire it still maintains watertight integrity.

- Double-sided installation inside an extended sleeve (length 312 mm)
- Certified protection for various types of plastic pipe
- Single plastic pipe penetrations
- Multiple pipe dimensions covered by one product size
- Certified fire, water and gas protection

RS PPS/S F+WT kit, acid-proof stainless steel fittings

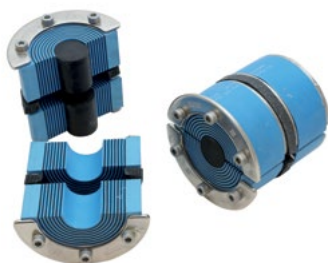

RS PPS/S F+WT

See information and measurements for RS PPS/S seal on page 172.

See installation instructions for RS PPS/S seal on page 239.

RATINGS

Fire: A class

Water pressure: 1.33 bar

Kit	For pipe Ø		For hole Ø		Weight		Art. No
	(mm)	(in)	(mm)	(in)	(kg)	(lb)	
WITH CORE							
RS PPS/S F+WT 43 AISI 316	0+ 4-23	0+ 0.157-0.906	43-45	1.693-1.772	0.5	1.106	107487
RS PPS/S F+WT 50 AISI 316	0+ 8-30	0+ 0.315-1.181	50-52	1.967-2.047	0.6	1.322	107488
RS PPS/S F+WT 68 AISI 316	0+ 26-48	0+ 1.024-1.890	68-70	2.677-2.756	0.98	2.160	107489
RS PPS/S F+WT 75 AISI 316	0+ 24-54	0+ 0.945-2.126	75-77	2.953-3.031	1.21	2.672	107490
WITHOUT CORE							
RS PPS/S F+WT 100 AISI 316 woc	48-70	1.890-2.756	100-102	3.937-4.016	1.88	4.140	107491
RS PPS/S F+WT 125 AISI 316 woc	66-98	2.598-3.858	125-127	4.921-5.000	2.61	5.758	107492
RS PPS/S F+WT 150 AISI 316 woc	93-119	3.661-4.685	150-152	5.906-5.984	3.3	7.270	107493

Sleeves for RS F+WT and RS PPS/S F+WT, primed mild steel



SLPPS primed mild steel

See practical user guidelines on page 264.

Sleeve	External dimensions				Internal dimensions		Weight		Art. No
	Ø (mm)	Ø (in)	L (mm)	L (in)	Ø (mm)	Ø (in)	(kg)	(lb)	
SLPPS 43 primed D=312	52	2.047	312	12.283	44	1.732	1.48	3.26	103626
SLPPS 50 primed D=312	63	2.480	312	12.283	51	2.008	2.64	5.80	103628
SLPPS 68 primed D=312	83	3.268	312	12.283	69.5	2.736	4.04	9.02	103630
SLPPS 75 primed D=312	89	3.504	312	12.283	76.5	3.012	4.10	8.90	103632
SLPPS 100 primed D=312	114	4.448	312	12.283	101	3.976	5.38	11.86	103634
SLPPS 125 primed D=312	140	5.512	312	12.283	126	4.961	7.16	15.80	103636
SLPPS 150 primed D=312	164	6.457	312	12.283	151	5.945	7.88	17.36	103638

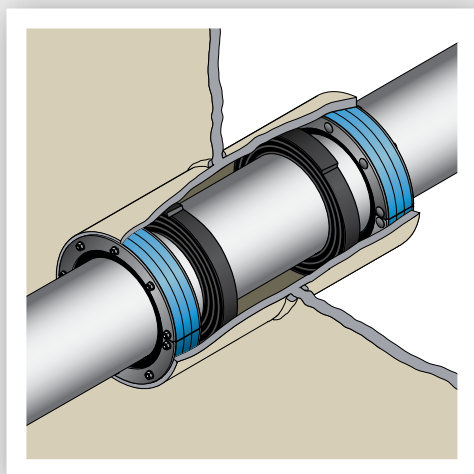

Roxtec RS PPS F+WT

The Roxtec RS PPS F+WT is a back-to-back sealing solution for openings with single plastic pipe penetrations in bulkheads where there is a demand for water-tightness after a fire. The kit solution is an extension of the RS PPS/S F+WT solution as it protects larger plastic pipe diameters by following a similar design. To achieve this, the solution requires a longer extended sleeve. The kit also consists of two standard RS seals and two intumescent based sealing strips which need to be wrapped around the plastic pipe and placed inside the sleeve before the RS seals are tightened. Once installed, the sealing solution will efficiently block smoke and flames from passing through the penetration, and after a fire it will still maintain watertight integrity.

- Double-sided installation inside an extended sleeve (length 700 mm)
- Certified protection for various types of plastic pipe
- Single plastic pipe penetrations
- Multiple pipe dimensions covered by one product size
- Certified fire, water and gas protection

RS PPS F+WT kit, acid-proof stainless steel fittings



RS PPS F+WT

See information and measurements for RS PPS seal on page 176.

See installation instructions for RS PPS seal on page 237.

RATINGS Fire: A class Water pressure: 1.33 bar

Kit	For pipe Ø		For hole Ø		Weight		Art. No
	(mm)	(in)	(mm)	(in)	(kg)	(lb)	
WITHOUT CORE							
RS PPS F+WT 300 AISI 316 woc	206-236	8.110-9.291	300-303	11.811-11.929	11.8	26.015	109181
RS PPS F+WT 350 AISI 316 woc	244-286	9.606-11.260	350-353	13.780-13.898	15	33.069	109182
RS PPS F+WT 400 AISI 316 woc	294-336	11.575-13.228	400-403	15.748-15.866	18.2	40.124	109183

Sleeves for RS PPS F+WT, primed mild steel



SLPPS primed mild steel

See practical user guidelines on page 264.

Sleeve	External dimensions				Internal Ø		Weight		Art. No
	Ø (mm)	Ø (in)	L (mm)	L (in)	(mm)	(in)	(kg)	(lb)	
SLPPS 300 primed D=700	314	12.362	700	27.559	302	11.890	31.9	70.33	121050
SLPPS 350 primed D=700	364	14.331	700	27.559	352	13.858	37.08	81.74	109190
SLPPS 400 primed D=700	414	16.299	700	27.559	402	15.827	42.26	93.17	123022

ROXTEC PIPE SEAL SELECTION GUIDE

FOR MARINE APPLICATIONS

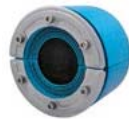
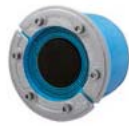

APPLICATION – PIPE SYSTEM	TRADITIONAL PIPE MATERIAL	RS seal	RS OMD seal	SPM seal	RS X seal	RS PPS seal
Grey water systems – transfer & collection	STEEL	✓	✓	✓	✓	
	PLASTIC					✓
	GLASS FIBER	✓	✓		✓	
Black water systems – transfer & collection	STEEL	✓	✓	✓	✓	
	PLASTIC					✓
	GLASS FIBER	✓	✓		✓	
Black water systems – vacuum piping	STEEL	✓	✓	✓	✓	
	PLASTIC					✓
	GLASS FIBER	✓	✓		✓	
Vacuum cleaning system	PLASTIC					✓
Laundry water systems	STEEL	✓	✓	✓	✓	
	COPPER	✓	✓	✓	✓	
	PLASTIC					✓
Potable water systems	STEEL	✓	✓	✓	✓	
	STAINLESS STEEL	✓	✓	✓	✓	
	COPPER	✓	✓	✓	✓	
	PLASTIC					✓
	MULTILAYER					✓
Wet waste system	STAINLESS STEEL	✓	✓	✓	✓	
	PLASTIC					✓
Fresh water generation & treatment systems	STEEL	✓	✓	✓	✓	
	PLASTIC					✓
Chilled water systems	STEEL	✓	✓	✓	✓	
	STAINLESS STEEL	✓	✓	✓	✓	
	COPPER	✓	✓	✓	✓	
	PLASTIC					✓
	MULTILAYER					✓
Water heating systems/ cooling water systems	STAINLESS STEEL	✓	✓	✓	✓	
	COPPER	✓	✓	✓	✓	
	GLASS FIBER	✓	✓		✓	
Deck/window washing & high pressure water systems	STEEL	✓	✓	✓	✓	
	STAINLESS STEEL	✓	✓	✓	✓	
Sprinkler systems	STEEL	✓	✓	✓	✓	
	STAINLESS STEEL	✓	✓	✓	✓	
CO2 extinguishing systems	STEEL	✓	✓	✓	✓	
	STAINLESS STEEL	✓	✓	✓	✓	
	COPPER	✓	✓	✓	✓	
Vents & overflow systems	STEEL	✓	✓	✓	✓	
	STAINLESS STEEL	✓	✓	✓	✓	
	COPPER	✓	✓	✓	✓	
	PLASTIC					✓
	MULTILAYER					✓
	GLASS FIBER	✓	✓		✓	

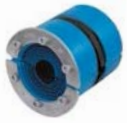

RS PPS/S seal	R frame	R X frame	S frame	SE PPS extension frame	Sleeve-it Fire pen. seal	Sleeve-it Waterproof pen. seal
	✓	✓	✓	✓		
✓				✓	✓	✓
	✓	✓	✓	✓	✓	
✓				✓	✓	✓
	✓	✓	✓	✓	✓	
✓				✓	✓	✓
	✓	✓	✓	✓	✓	
✓				✓	✓	✓
	✓	✓	✓	✓	✓	
✓				✓	✓	✓
	✓	✓	✓	✓	✓	
✓				✓	✓	✓
	✓	✓	✓	✓	✓	
✓				✓	✓	✓
	✓	✓	✓	✓	✓	
✓				✓	✓	✓
	✓	✓	✓	✓	✓	
✓				✓	✓	✓
	✓	✓	✓	✓	✓	
✓				✓	✓	✓
	✓	✓	✓	✓	✓	
✓				✓	✓	✓
	✓	✓	✓	✓	✓	
✓				✓	✓	✓
	✓	✓	✓	✓	✓	
✓				✓	✓	✓
	✓	✓	✓	✓	✓	
✓				✓	✓	✓





































Note: Pipe seals should not be used in tank boundaries.
 This guide is for indication purposes only. Please check the applicable type approval certificate to confirm pipe dimensions and materials.





APPLICATION – PIPE SYSTEM	TRADITIONAL PIPE MATERIAL	RS seal	RS OMD seal	SPM seal	RS X seal	RS PPS seal
Water fire fighting system	STEEL	✓	✓	✓	✓	
Air conditioning – cooling & heat recovery systems	STEEL	✓	✓	✓	✓	
	STAINLESS STEEL	✓	✓	✓	✓	
	COPPER	✓	✓	✓	✓	
	PLASTIC					✓
Ballast water systems	STEEL	✓	✓	✓	✓	
	STAINLESS STEEL	✓	✓	✓	✓	
	COPPER	✓	✓	✓	✓	
	PLASTIC					✓
	MULTILAYER					✓
	GLASS FIBER	✓	✓		✓	
Scrubber systems	STEEL	✓	✓	✓	✓	
	STAINLESS STEEL	✓	✓	✓	✓	
	COPPER	✓	✓	✓	✓	
	PLASTIC					✓
	MULTILAYER					✓
	GLASS FIBER	✓	✓		✓	
Exhaust gas drainage systems	STEEL	✓	✓	✓	✓	
	GLASS FIBER	✓	✓		✓	
Bilge lines	STEEL	✓	✓	✓	✓	
	STAINLESS STEEL	✓	✓	✓	✓	
	PLASTIC					✓
	GLASS FIBER	✓	✓		✓	
Pneumatic/compressed air systems	STEEL	✓	✓	✓	✓	
	STAINLESS STEEL	✓	✓	✓	✓	
	COPPER	✓	✓	✓	✓	
Tank cleaning systems	STEEL	✓	✓	✓	✓	
	STAINLESS STEEL	✓	✓	✓	✓	
	COPPER	✓	✓	✓	✓	
Hydraulic fluid systems/ lubricating oil lines	STEEL	✓	✓	✓	✓	
	STAINLESS STEEL	✓	✓	✓	✓	
	COPPER	✓	✓	✓	✓	
Engine & fuel oil transfer systems	STEEL	✓	✓	✓	✓	
	STAINLESS STEEL	✓	✓	✓	✓	
	COPPER	✓	✓	✓	✓	
	GLASS FIBER	✓	✓		✓	
Azipod lubrication systems	STEEL	✓	✓	✓	✓	
	STAINLESS STEEL	✓	✓	✓	✓	
Bundle/multi-core pipe systems	STEEL	✓	✓		✓	
	STAINLESS STEEL	✓	✓		✓	
	COPPER	✓	✓		✓	
Insulated bundle pipe systems	PLASTIC					✓

Welded solution
 Non welded solution
 Requires a sleeve
 Above waterline solution
 Below waterline solution
 Water-tightness after fire (F+WT)

						
RS PPS/S seal	R frame	R X frame	S frame	SE PPS extension frame	Sleev-it Fire pen. seal	Sleev-it Waterproof pen. seal
     	    	  	    	    	  	 
	✓	✓	✓	✓		
	✓	✓	✓	✓		
	✓	✓	✓	✓		
	✓	✓	✓	✓		
✓				✓	✓	✓
	✓	✓	✓	✓		
	✓	✓	✓	✓		
	✓	✓	✓	✓		
✓				✓	✓	✓
✓				✓	✓	✓
	✓	✓	✓	✓		
	✓	✓	✓	✓		
	✓	✓	✓	✓		
✓				✓	✓	✓
✓				✓	✓	✓
	✓	✓	✓	✓		
	✓	✓	✓	✓		
	✓	✓	✓	✓		
	✓	✓	✓	✓		
	✓	✓	✓	✓		
	✓	✓	✓	✓		
	✓	✓	✓	✓		
	✓	✓	✓	✓		
	✓	✓	✓	✓		
	✓	✓	✓	✓		
	✓	✓	✓	✓		
	✓	✓	✓	✓		
	✓	✓	✓	✓		
	✓	✓	✓	✓		
	✓	✓	✓	✓		
	✓	✓	✓	✓		
	✓	✓	✓	✓		
	✓	✓	✓	✓		
	✓	✓	✓	✓		
	✓	✓	✓	✓		
	✓	✓	✓	✓		
	✓	✓	✓	✓		
	✓	✓	✓	✓		
	✓	✓	✓	✓		
	✓	✓	✓	✓		
	✓	✓	✓	✓		
	✓	✓	✓	✓		
	✓	✓	✓	✓		
✓					✓	✓

Note: Pipe seals should not be used in tank boundaries.

This guide is for indication purposes only. Please check the applicable type approval certificate to confirm pipe dimensions and materials.

RETROFIT SOLUTIONS



Always ready for upgrades

Modern shipbuilding is very much focused on quick, extensive refurbishment and parallel working methods. The design is often made at the same time as the construction work in the shipyard. Therefore, it is crucial to select the right seals that are readily available in order to be prepared for retrofit work and upgrades.



Open for any changes

Roxtec multi-cable and pipe sealing solutions are rapidly delivered locally all over the world and well-known by marine engineers and shipyard workers worldwide. The safety solutions include extremely flexible frames, seals and sleeves that can be opened, reconfigured and resealed in a very easy way. Roxtec sealing modules and rubber bodies are even adaptable to cables and pipes of different sizes.

Eliminate welding time

You can install the seals around existing cables and pipes, from the beginning of the project or whenever it may be needed. There are a range of bolted non-weld solutions allowing retrofit work and safety enhancements to be made onboard while at sea. Remember that each day out of service is a day with lost revenue.

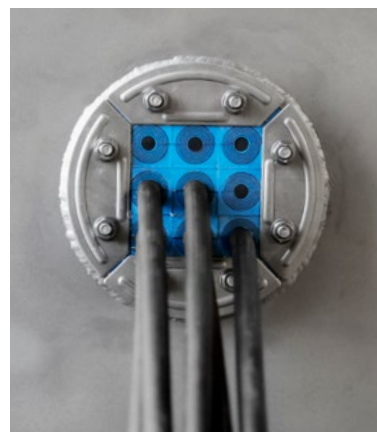

Built-in spare capacity

You also have the option to include spare capacity from the start by installing more sealing modules than cables and pipes. The solid core of the module keeps tight until the day you want to open up the transit and add a cable or pipe for new equipment! The built-in spare capacity allows for quick and cost-efficient upgrades to new regulations during the entire lifespan of a ship's operation.

"Future included"

This feature ensures that your cargo ship can be revitalized and stay operational for years to come and that your cruise ship is ready to be rebuilt in order to accommodate new and amazing attrac-

tions. As the spare modules are already installed on the ship, you can add equipment without adding new material or costs. And you can actually do it without hot work permits or any downtime at all.

Easy pipe sealing retrofit

One example showing the simplicity is the Roxtec RS seal. If you are to turn a worn supply unit into an environmentally aware high-tech multi-purpose supply vessel, you only need to bring Roxtec RS in sizes 50, 75, 100 and 125 to cover pipes ranging from 8 to 98 mm. With these four sizes, you manage at least 75 percent of all pipes used. Save oceans of time and avoid weight and logistic challenges.

Few modules cover many cables

You have the same material reducing benefit when it comes to cable sealing. Do you only have a few months to retrofit an aged cruise liner, demolish most of its interior, give it a new identity and make it luxurious, attractive and profitable again? Make sure you bring Roxtec RM 20w40, 30, 40 and 60 modules. With very few standard modules, you will be able to seal cables ranging from 3.5 to 54 mm.

Roxtec retrofit solutions

These Roxtec solutions are especially retrofit-friendly:

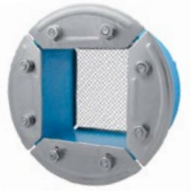

Roxtec R frame

See page 63 for cables, 150 for pipes.



Roxtec RS seal

See page 69 for cables, 138 for pipes.



Roxtec RS OMD seal

See page 78 for cables, 147 for pipes.



Roxtec RS PPS seal

See page 147.



Roxtec R X frame

See page 81 for cables, 159 for pipes.



Roxtec RS X seal

See page 81 for cables, 159 for pipes.



Roxtec openable sleeve

See page 68 and 77 for cables, 146 and 155 for pipes.



Roxtec Sleeve-it™ Fire penetration seal

See page 182.



Roxtec KFO frame

See page 94.



Roxtec C KFO frame

See page 96.



Roxtec ComSeal™

See page 88.



Roxtec SO frame



Roxtec SFO frame



Roxtec SFOH frame

You are always welcome to send an email to info@roxtec.com or contact your Roxtec representative if you want more information or if you want to discuss possible retrofit solutions.

We do not further present the SO, SFO and SFOH frames in this catalogue, but they are in fact openable versions of the S frame (see page 40 for cables, 163 for pipes) and the SF frame (see page 56), respectively.

Retrofit sleeves and frames – examples of how it works

Roxtec SLFO/RI sleeve

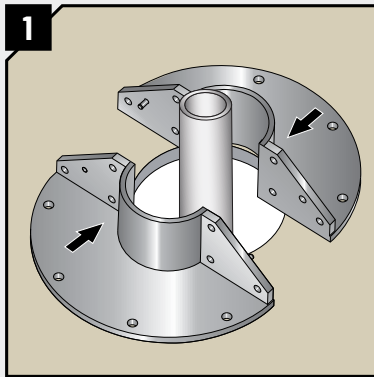

The Roxtec SLFO/RI is an openable sleeve consisting of two identical halves which are placed round a cable or pipe to form a robust circular sleeve. It has a wide flange to cover large cut-outs in decks or bulkheads and allow the installation of pre-fanged pipes.

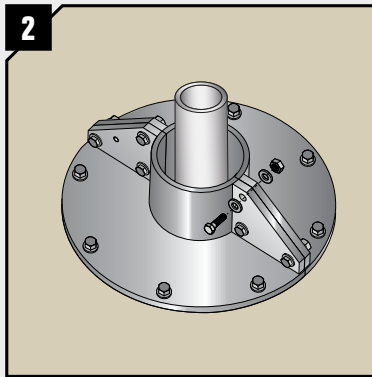

The two halves are bolted together and also directly to the steel division to form a tight seal protecting against fire, water and gas. A fitted gasket between the sleeve and the steel division assists in maintaining tightness.

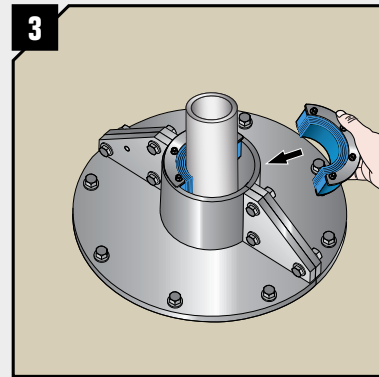

The circular sleeve is fitted with a flexible Roxtec RS seal with Multidiameter™. The cable or pipe is sealed tight by removing layers to adapt the seal to fit. The sleeve can be customized for larger sizes.

Roxtec SFOHK frame

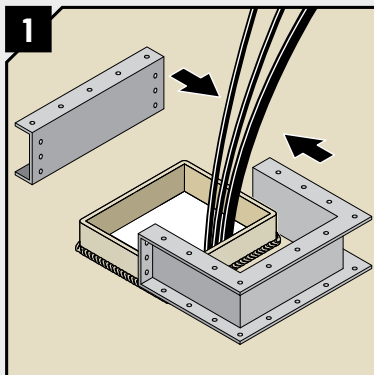

The Roxtec SFOHK frame is a robust openable frame to be used for retrofit or around existing cables.

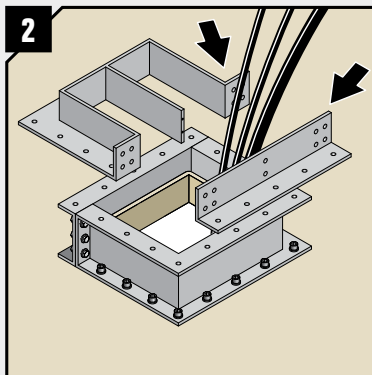

It has an openable collar to distance the transit from the steel division making it possible to use without removing the old cable transit. It perfectly solves problems such as too many cables or the change of any former solution or an entire piping system.

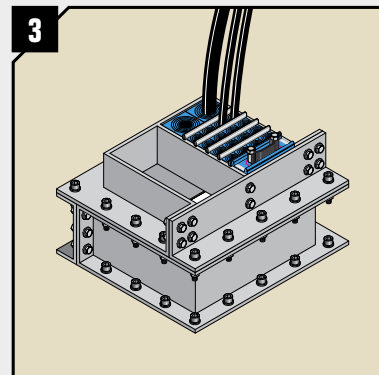

There is no need for welding. When bolted together, the Roxtec SFOHK frame forms a tight seal against the steel division providing protection against fire, gas and water.

Your partner in retrofit

Dedicated to first class safety, we offer everything from installation quality trainings and inspection services through to design support and customized solutions.

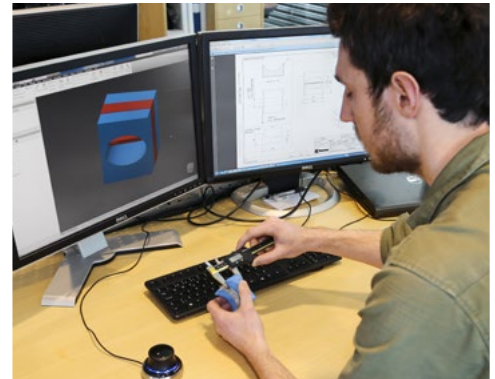

Our retrofit offering ranges from web-based applications for design through to inspections at shipyards. Our goal is to help you ensure that all deck and bulkhead penetrations are correctly and safely sealed. And we are eager to follow and support your project for years to come.

Experienced inspectors

Our team of installation inspectors can go onsite to make sure that our seals are properly installed, to follow-up projects and to help you plan for upgrades. They conduct visual inspections

of our transits at shipyards all over the world. The standardized inspection process results in a detailed visual inspection report, enabling you to understand the status of each one of your installed transits.

Maintenance planning

The report is used to evaluate safety concerns and also to generate a priority list if changes or corrective actions are needed. We help you keep track of your cable and pipe transits. It is, for example, a great advantage to know all facts about earlier

changes when you make plans for refurbishments and future upgrades. We offer:

- Trainings
- Inspections
- Design and engineering
- Tailored solutions
- Documentation
- Built-in spare capacity
- Easy maintenance

CUSTOMIZED SOLUTIONS

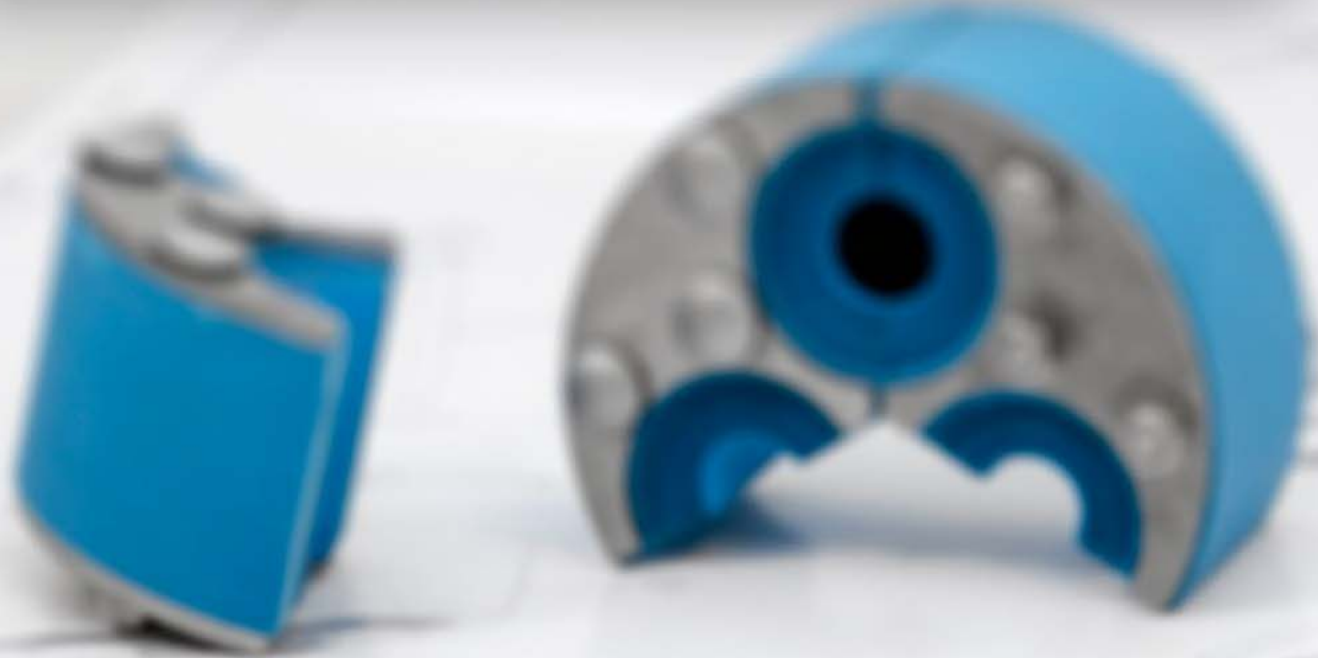

ITEM	QTY.	DESCRIPTION	UNIT	REVISION
1	1	INSTALLATION INSTRUCTION	10ML	
2	1	LUBRICANT	ROXYLON	
3	F	CORE	BRB M6 ISO 7089 A4	
4	9	WASHER	EPDM	
5	9	GASKET INBF	INBF 16x65 DIN 613 A4	
6	9	SCREW	ACID PROOF STAINLESS STEEL	
7	9	NUT	ACID PROOF STAINLESS STEEL	
8	9	SMALL FITTING	ROXYLON	
9	9	LARGE FITTING	ROXYLON	
10	1	RUBBER FRAME	ROXYLON	



www.roxtec.com

H3 SEAL ASSEMBLY 150-200

Information Drawing

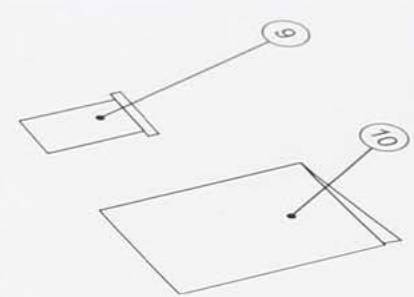

Tailor-made according to your needs

We are here to solve your sealing problem – even when it requires the creation of an entirely new customized solution. We have an entire team with designers, engineers and test technicians ready to develop and test tailored cable and pipe transits according to your needs.

Covering all requirements

The certified Roxtec sealing system is normally the base, but we can supply it in many other dimensions than the standard ones, with special frames, other rubber materials or customized sealing modules. We have, for example, in cooperation with our customers, created solutions for insulated busway systems and service locker flanges in order to cover specific requirements.

Experience in innovation

If you need a special sealing solution, you can just inform your local Roxtec representative about the specific requirements. In many cases, we have already supplied a similar sealing solution, somewhere in the world, allowing us to respond very quickly to your request.



Prefabricated multi-penetrations

Roxtec can offer prefabricated plates of any size or shape that incorporate multiple penetrations for either pipes and/or cables. The design is bespoke to customer requirements and the solution will enable the customer to make only one opening for multiple pipes or cables. This is an efficient way of preparing for applications where the same installation designs are frequently repeated.

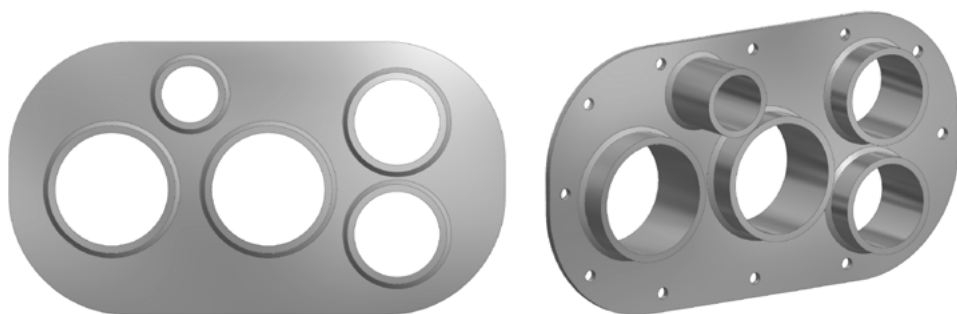
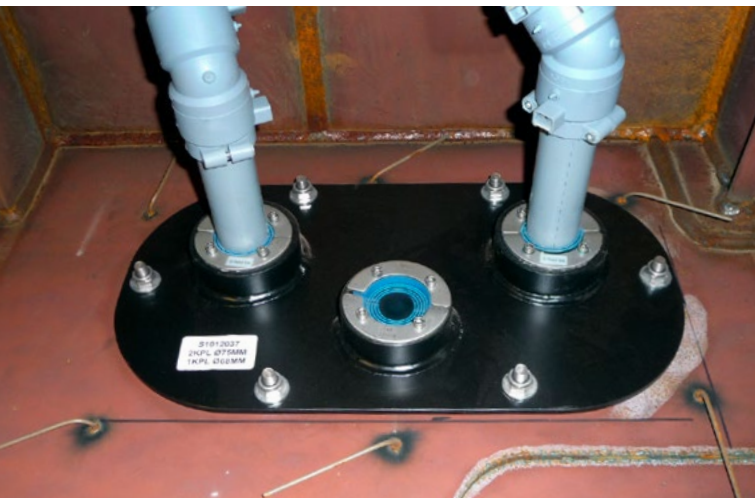

Roxtec multi-penetration plates in stainless or mild steel help you secure your pipe or cable sealing needs in advance.

Flexible off-center solutions

Roxtec customized off-center solutions are useful when cables or pipes are already fixed or too heavy to move. The solutions consist of extremely flexible round single penetration seals. They are beneficial when it is impossible to change the position of an existing pipe or a stiff already connected power cable. You just turn the seal according to the cable or pipe, and secure it in its transit position.

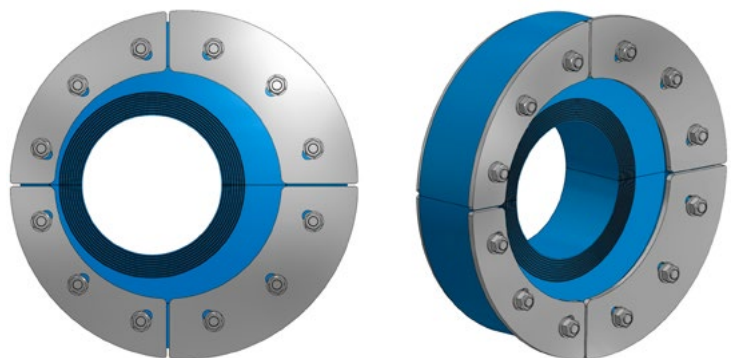
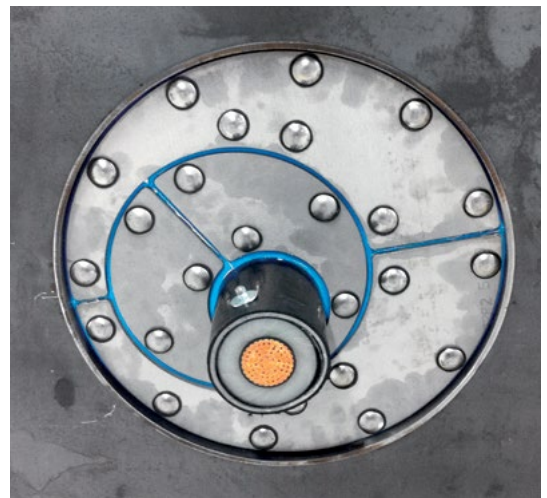
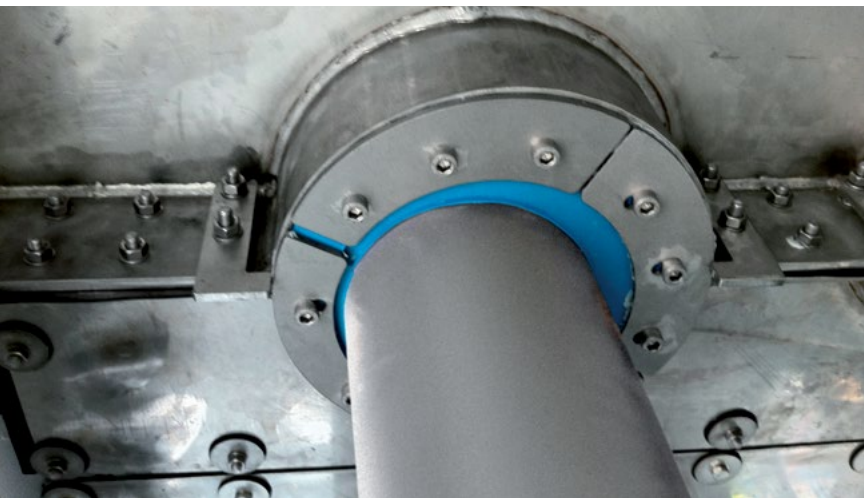

Roxtec off-center seals simplify installation of large, pre-terminated cables or pipes that are difficult to position.

CABLE AND PIPE MANAGEMENT



Systems for flexible fixation

Roxtec cable sealing and management systems are used worldwide. It is beneficial for you to select one experienced supplier for an entire package including both cable straps and sealing solutions.



Our innovative cable management solutions are used to ensure safety, efficiency and operational reliability. They simplify design and engineering, speed up installation work and reduce the need for stock, material and logistics in a wide range of projects.

Complete solutions

We have a long, impressive story when it comes to developing cable management products and provide systems for use in marine applications even under extreme conditions. Our products have been tested over time and cover a wide range of needs.





Roxtec cable straps

Roxtec plastic-coated metal straps help you ensure quick, easy and safe fixation of cables. The straps are mechanically strong and resistant to fire. They fulfill the technical requirements regarding regular metallic fixation of cables to the cable racks and are approved by leading classification societies.

- Available in three materials
- Available in fixed lengths or rolls
- Tightening tool with cutting function
- Damp heat test, cyclic, acc. to DIN EN 60068-2-30
- Salt fog test, acc. to rules of RMRS, edition 2012 (part IV. Technical supervision during manufacture of products – item 10.5.4.5.6)

Roxtec cable straps



Roxtec cable straps

Length		15 x 0.5 mm / 0.59 x 0.02 inch			8 x 0.3 mm / 0.31 x 0.01 inch	
		GREY	BLACK	BROWN	BLACK	BROWN
mm	inch	Steel, hot dip galvanized	Stainless steel, AISI 430 (1.4016) (A2-class)	Stainless steel, a-mag AISI 316 (1.4571) (A4-class)	Stainless steel, AISI 304 (1.4301) (A2-class)	Stainless steel, a-mag AISI 316 (1.4571) (A4-class)
200	7.87	—	—	—	GK000000260044	GK000000260429
300	11.81	GK000000101006	GK000000101102	GK000000100046	GK000000100900	GK000000200779
400	15.75	GK000000101007	GK000000101103	GK000000100048	GK000000100904	GK000000210817
500	19.68	GK000000101008	GK000000101104	GK000000100050	GK000000100906	GK000000210822
600	23.62	GK000000101009	GK000000101105	GK000000100169	GK000000100908	GK000000210824
700	27.56	GK000000101100	GK000000101106	GK000000100185	—	—
800	31.50	GK000000101101	GK000000101107	GK000000100187	—	—
900	35.43	GK000000210806	GK000000210812	GK000000210809	—	—
1000	39.37	GK000000100710	GK000000100809	GK000000100375	—	—

Rolls



15 x 0.5 mm, 25 m, ca 1,8 kg / 0.59 x 0.02 inch, 82 ft, 3.97 lb			8 x 0.3 mm, 75 m, ca 1,9 kg / 0.31 x 0.01 inch, 246 ft, 4.19 lb	
GREY	BLACK	BROWN	BLACK	BROWN
Steel, hot dip galvanized	Stainless steel, AISI 430 (1.4016) (A2-class)	Stainless steel, a-mag AISI 316 (1.4571) (A4-class)	Stainless steel, AISI 304 (1.4301) (A2-class)	Stainless steel, a-mag AISI 316 (1.4571) (A4-class)
GK000000101001	GK000000101002	GK000000101003	GK000000101004	GK000000201251

Strap clip



15 x 0.5 mm / 0.59 x 0.02 inch			8 x 0.3 mm / 0.31 x 0.01 inch	
GREY	BLACK	BROWN	BLACK	BROWN
Steel, hot dip galvanized	Stainless steel, AISI 304 (1.4301) (A2-class)	Stainless steel, a-mag AISI 316 (1.4571) (A4-class)	Stainless steel, AISI 304 (1.4301) (A2-class)	Stainless steel, a-mag AISI 316 (1.4571) (A4-class)
GK000000101108	GK000000101109	GK000000101200	GK000000101201	GK000000200435

Tightening tools



Type 140



Type 142

Type 140, with cutting function up to 15 mm / 0.59 inch	Type 142, without cutting function up to 8 mm / 0.31 inch
GK000000101400	GK000000101402

Installation

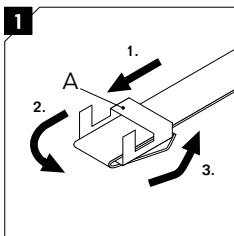

Insert strap into the strap clip. (A)*

* Only when strap box is used

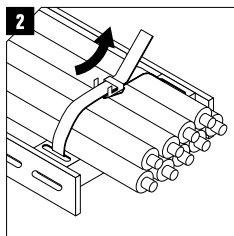

Bend the strap around the cable, through the cable tray and back through the clip.

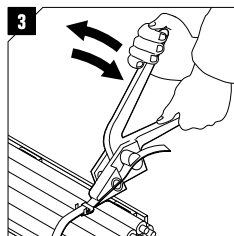

Tighten strap by hand, apply tightening tool to the clip and tighten strap by means of the movable arm.

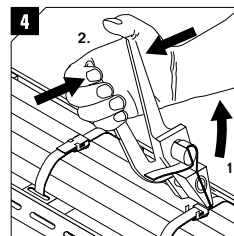

When it is tightened, bend the strap over the clip and cut it.

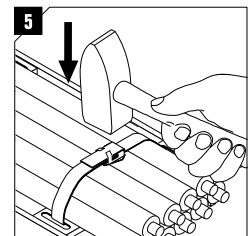

Bend the strap completely. Bend the flaps of the clip over the strap. Secure it by hitting with a hammer.

The latest version of this document is available on www.roxtec.com.

Speed up and secure your installation

We have developed a range of practical tools to simplify quick and safe onsite installations and reinstalls of Roxtec sealing solutions.



The tools are handy for anyone working with the installation of Roxtec solutions including frames, modules and wedges. Include a selection of tools in your next specifications and bills of materials in order to maximize efficiency.



Roxtec Pre-compression tool

For regular frames in all sizes. This user-friendly pre-compression tool comes in a small and a large version. Use it to compress rows of installed modules and stay-plates to make more room for the following row and the Roxtec Wedge. The tool helps keeping all items in place during installation.



Pre-compression tool, small



Pre-compression tool, large

Tool	Art. No
Pre-compression tool, small	5ICT000001269
Pre-compression tool, large	ICT0001000000

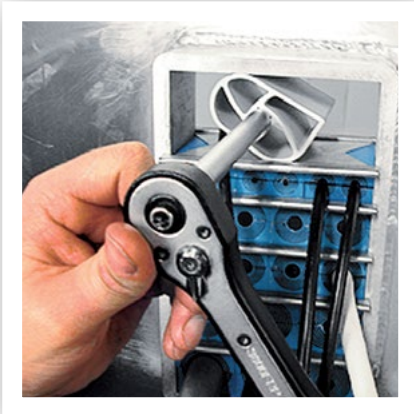

Roxtec Pre-compression eccentric tool

A convenient assembly tool for pre-compression. The tool has a 3/8" square drive, which fits most types of socket wrenches. When the tool is turned with a wrench, it will compress the modules and leave room for more modules and/or the wedge. It is easily handled and provides pre-compression in only a few seconds. It is available in three sizes and for both regular frames and compact frames such as Roxtec CF 8/32, Roxtec ComSeal and Roxtec C KFO.



Pre-compression eccentric tool, small



Pre-compression eccentric tool, large



Pre-compression eccentric tool, compact

Tool	Art. No
Pre-compression eccentric tool, small	ICT0001000302
Pre-compression eccentric tool, large	ICT0001000301
Pre-compression eccentric tool, compact	ICT0001000316

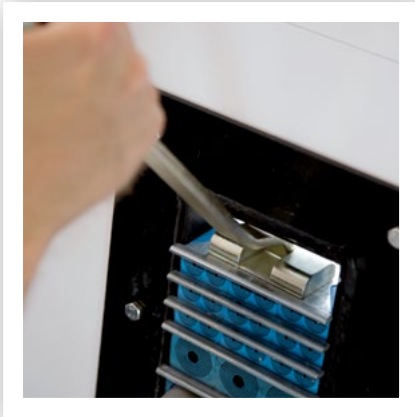

Roxtec Handgrip pre-compression tool

For regular frames in all sizes. The handgrip pre-compression tool simplifies quick and easy installation. With this tool, you can pre-compress the installed modules evenly while keeping them in place. This gives you more packing space to insert and install the wedge in a safe and smooth way.



Handgrip pre-compression tool

Tool	Art. No
Handgrip pre-compression tool	ICT0001000401



Roxtec Pre-compression wedge

For regular frames in all sizes. This tool is handy when you need to make room for the wedge during assembly. It fits easily into the frame and expands to almost twice its size when the bolt is tightened. Leave it for a few minutes and then loosen the bolt. The wedge returns to its original size and is easy to pull out. The modules stay compressed for a while, leaving room for the wedge to be inserted.



Pre-compression wedge 60/40



Pre-compression wedge 120

Tool	Art. No
Pre-compression wedge 60/40	5ICT000003691
Pre-compression wedge 120	ICT0001000500



Roxtec Stayplate clamps

Horizontal installations become much more convenient and faster with this tool. By fixing a stayplate holder on each stayplate edge, each finished row of modules and cables is firmly kept in position. You work with them in pairs and the modules are efficiently prevented from falling through the transit. Width 120 mm, 4.724".



Stayplate clamps

Tool	Art. No
Stayplate clamps, 2 pcs	ICT0001000100

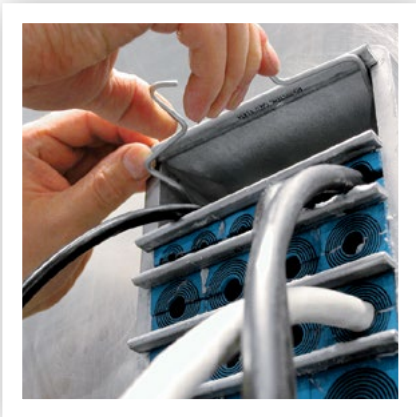

Roxtec Stayplate clip

The stayplate clip provides help during installation. Attach it below the top stayplate to keep it out of the way until it is time to put it in position on top of the last row of modules. For use with RM stayplates, width 120 mm, 4.724".



Stayplate clip

Tool	Art. No
Stayplate clip	ICT0001000200



Roxtec Wedge puller

Simplifies removal of the wedge for maintenance and retrofit work where space is limited.



Roxtec Wedge puller

Tool	Art. No
Roxtec Wedge puller	103248



Roxtec Module Adaption Indicator

Measuring tool for easier selection of sealing module. Indicates how many rubber layers to peel off to achieve perfect adaption. It also simplifies inspection.



Module Adaption Indicator

Tool	Art. No
Module Adaption Indicator	IQR2009000101



Roptec Pressure Test Pipe

The test pipe is used for verifying a transit's integrity after installation on site. To be used with RM components in back-to-back solutions.



Pressure Test Pipe

Tool

Pressure Test Pipe

Art. No

ICT2006000130



Roptec Welding Fixture tool

Holds the frame within tolerance during welding.



Welding Fixture tool

Tool

Welding Fixture tool

Art. No

121932

EASY INSTALLATION WITH ROXTEC





INSTALLATION INSTRUCTIONS 220

Roxtec rectangular system	
S frame	222
SK frame	222
SBTB frame	222
SF frame	222
GHM frame	222
G frame	222
SRC frame	226
R frame	231
RS seal	233
SPM seal	235
RS PPS seal	237
RS PPS/S seal	239
ComSeal	241
CF 8/CF 32 frames	243
Sleev-it Fire penetration seal	245
Sleev-it Waterproof penetration seal	249
Sleev-it Transition collar	251

TRAININGS AND INSPECTIONS 253

Installation checkpoints, rectangular frames	254
Installation checklist, rectangular frames	258
Installation checkpoints, round frames	259
Installation checklist, round frames	263

Our installations instructions are available on www.roxtec.com, and you can watch our installation movies on YouTube.

Roxtec rectangular system

ALWAYS CHECK OUR LATEST UPDATES

You find the latest versions of our installations instructions on www.roxtec.com. Roxtec can and will not take responsibility for transits that are not installed according to the latest installation instructions.

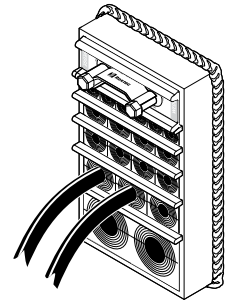

Parts

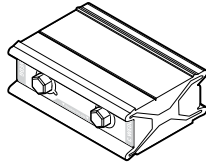

Wedge

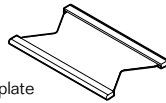

Stayplate

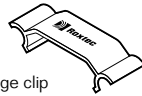

Wedge clip

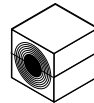

Module



Lubricant

Installation

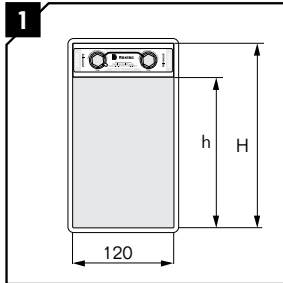

Measure your frame height (H). This corresponds to your packing height (h) according to the table. Consider your packing height when inserting the modules.

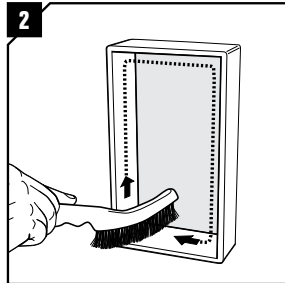

Clean the frame.

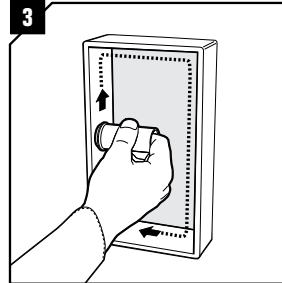

Lubricate the inside surfaces of the frame all around with Roxtec Lubricant, especially into the corners.

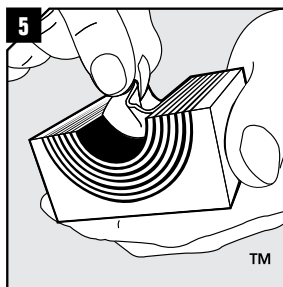
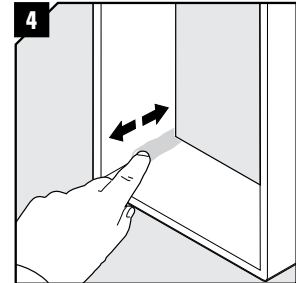

Adapt modules, which are to hold cables or pipes, by peeling off layers until you reach the gap seen in pic. 6. The number of layers may not differ by more than one between the halves.

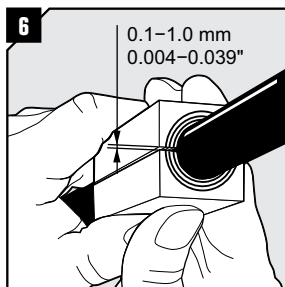

Achieve a 0.1–1.0 mm gap between the two halves when held against the cable/pipe.

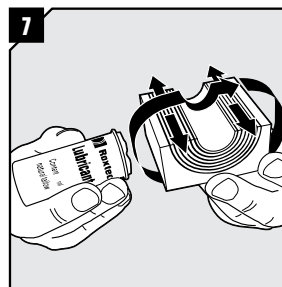

Lubricate all modules thoroughly, both the inside and the outside sealing surfaces.

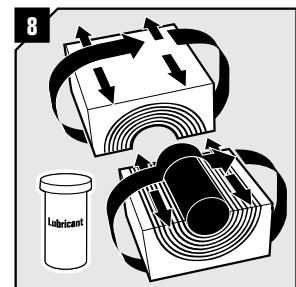

Do not remove the center cores of the spare modules.

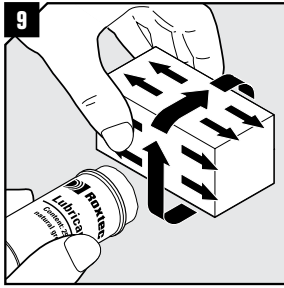

Lubricate solid modules on the sealing surfaces.

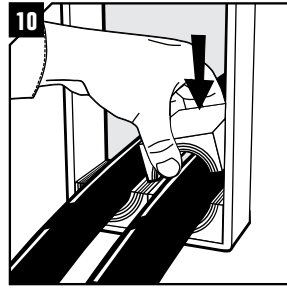

Insert the modules according to your installation plan (transit plan). Place the spare modules as close to the wedge as possible to simplify future installations.

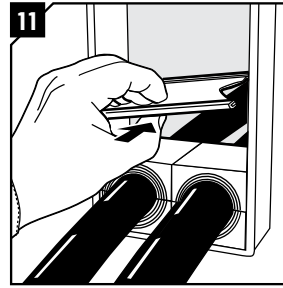

Insert a stayplate on top of every finished row of modules.

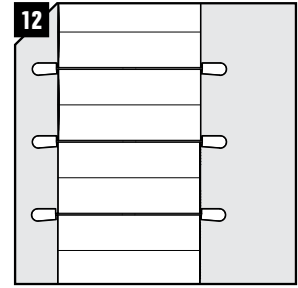

Ensure that the modules are secured within the stayplate edges.

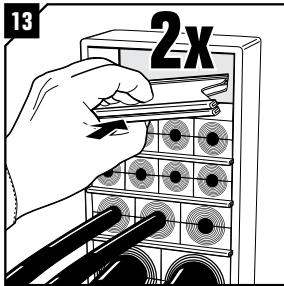

Before inserting the final row of modules, insert two stayplates.

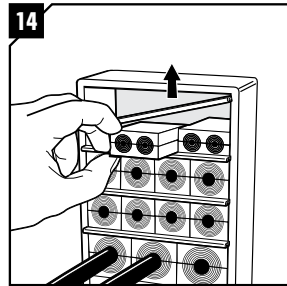

Separate the two stayplates and insert the final row of modules between the stayplates.

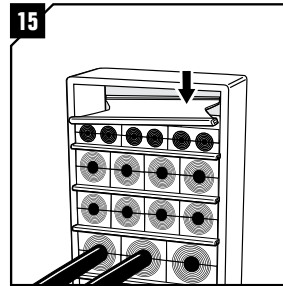

Drop the upper stayplate on top of the modules.

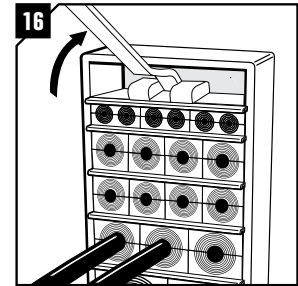

If there is not enough room for the wedge, insert the optional Roxtec pre-compression tool.

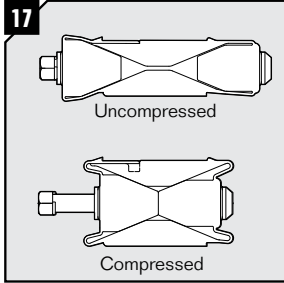

Ensure that the wedge is fully uncompressed by untightening the screws of the wedge before inserting the wedge.

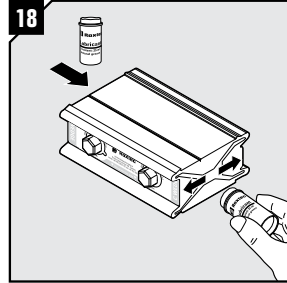

Lubricate the short sides of the wedge.

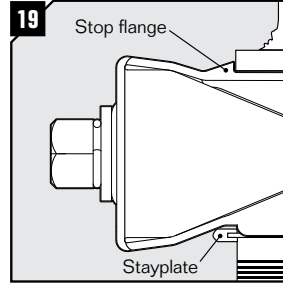

Orientate the wedge so the face marked "Stayplate this side" faces a stayplate. Insert the wedge to the stop flange. Ensure that the wedge is accommodated and secured by the stayplate.

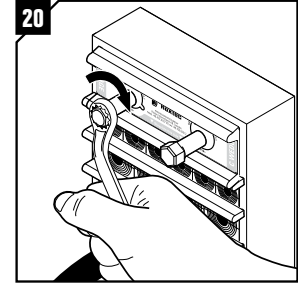

Tighten the screws alternately until full mechanical stop, approx 20 full revolutions per screw. Do not exceed 20 Nm (15 ft.lb.).

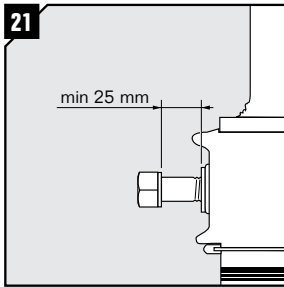

25 mm of the screws shall be exposed.

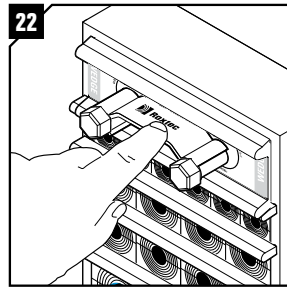

Attach the wedge clip to the wedge screws to complete the installation.

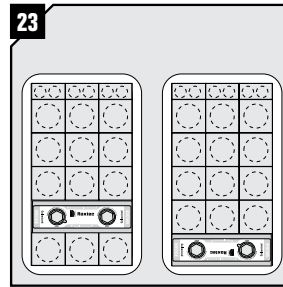

Optional wedge positions (anywhere in frame).

Disassembly

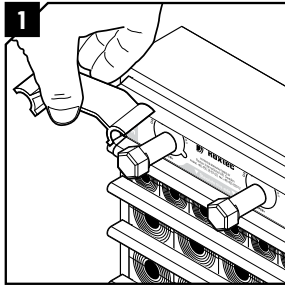

1 Remove the wedge clip from the wedge.

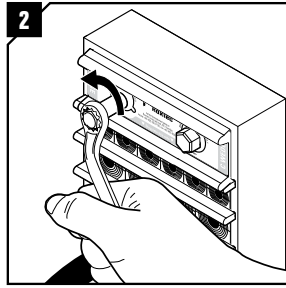

2 Release the compression by loosen the screws alternately to full stop. Do not exceed 20 Nm (15 ft.lb.).

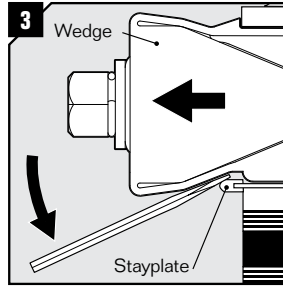

3 Insert a flat tool between the wedge and the stayplate to simplify removal of the wedge. Roxtec special tools are available.

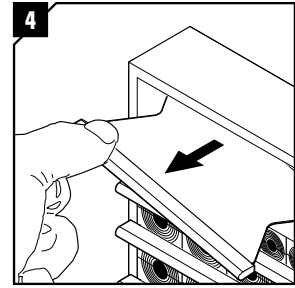

4 Remove the stayplate.

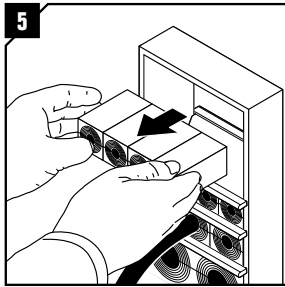

5 Remove the modules required. Keep the rows sorted until it is time to re-install the transit. If a module is damaged or replaced, all modules in that row must be replaced.

Re-installation

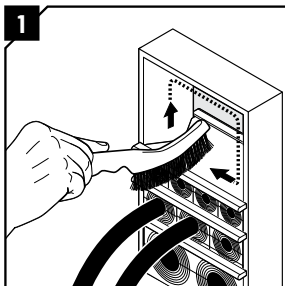

1 Make sure that the inside surfaces of the exposed packing space are free from dirt or dust.

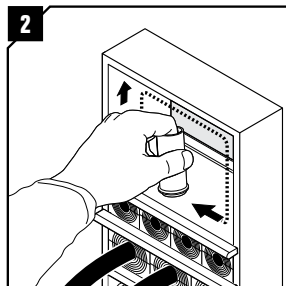

2 Lubricate the inside surfaces all around with Roxtec Lubricant, especially into the corners. Continue from step 5 under "Installation".

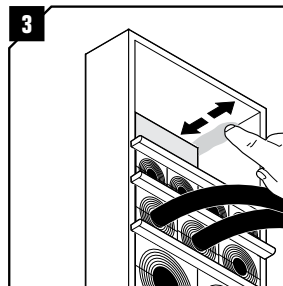

Packing space

Frame height (H)	Packing height (h)	Frame size
101	60	2
160	120	4
218	180	6
278	240	8

- Wait 24 hours or longer after installation before exposing the cables/pipes to strain or pressure.
- Wedge is to be used with: RM components.
- Cables shall go straight through the frame.
- Amendments to these installation instructions are available on www.roxtec.com.
- Ensure that the wedge clip is attached to the wedge bolts.

DISCLAIMER

"The Roxtec cable entry sealing system ("the Roxtec system") is a modularbased system of sealing products consisting of different components. Each and every one of the components is necessary for the best performance of the Roxtec system. The Roxtec system has been certified to resist a number of different hazards. Any such certification, and the ability of the Roxtec system to resist such hazards, is dependent on all components that are installed as a part of the Roxtec system. Thus, the certification is not valid and does not apply unless all components installed as part of the Roxtec system are manufactured by or under license from Roxtec ("authorized manufacturer"). Roxtec gives no performance guarantee with respect to the Roxtec system, unless (I) all components installed as part of the Roxtec system are manufactured by an authorized manufacturer and (II) the purchaser is in compliance with (a), and (b), below.

(a) During storage, the Roxtec system or part thereof, shall be kept indoors in its original packaging at room temperature.

(b) Installation shall be carried out in accordance with Roxtec installation instructions in effect from time to time.

The product information provided by Roxtec does not release the purchaser of the Roxtec system, or part thereof, from the obligation to independently determine the suitability of the products for the intended process, installation and/or use. Roxtec gives no guarantee for the Roxtec system or any part thereof and assumes no liability for any loss or damage whatsoever, whether direct, indirect, consequential, loss of profit or otherwise, occurred or caused by the Roxtec systems or installations containing components not manufactured by an authorized manufacturer and/or occurred or caused by the use of the Roxtec system in a manner or for an application other than for which the Roxtec system was designed or intended.

Roxtec expressly excludes any implied warranties of merchantability and fitness for a particular purpose and all other express or implied representations and warranties provided by statute or common law. User determines suitability of the Roxtec system for intended use and assumes all risk and liability in connection therewith. In no event shall Roxtec be liable for indirect, consequential, punitive, special, exemplary or incidental damages or losses."



Roxtec SRC frames

ALWAYS CHECK OUR LATEST UPDATES
 You find the latest versions of our installations instructions on www.roxtec.com.
 Roxtec can and will not take responsibility for transits that are not installed according to the latest installation instructions.

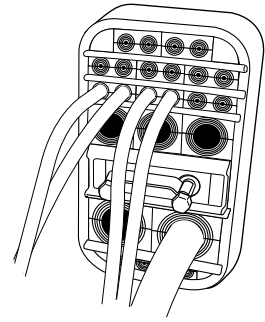

Frame types

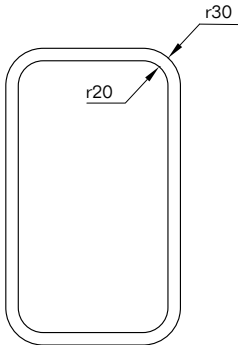

SRC r20 frame

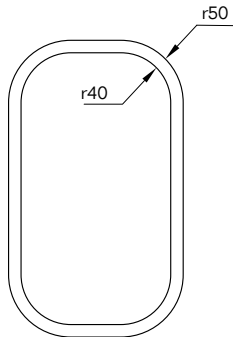

SRC r40 frame

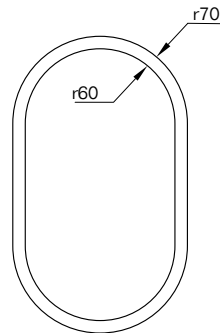

SRC r60 frame

Packing of SRC frames

You will need 4 pieces of RC modules to compensate for the corner radius.
 These RC modules will have an impact on the available packing space.

r20 frame

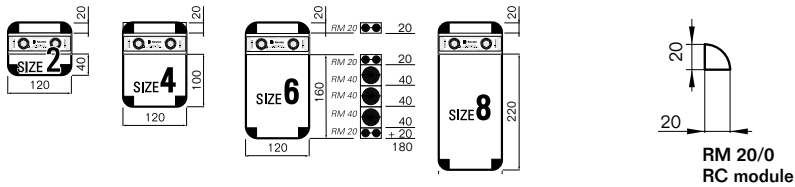

r40 frame

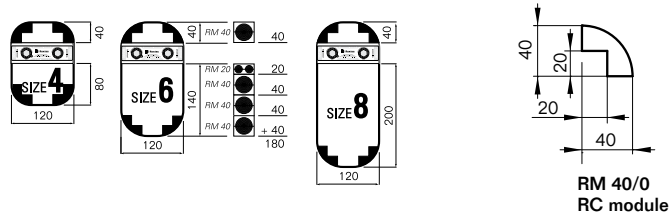

r60 frame

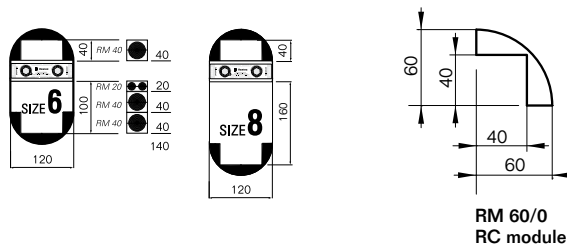

Installation

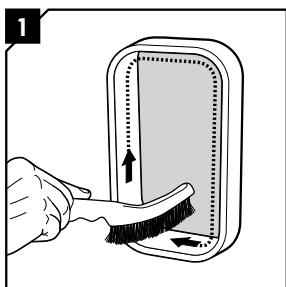

Make sure that the inside surfaces of the frame are free from dirt or dust.

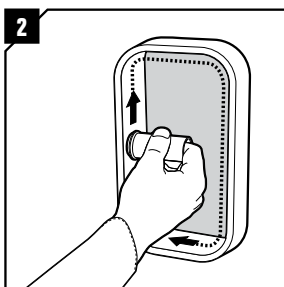

Lubricate the inside surfaces of the frame with Roxtec Lubricant.

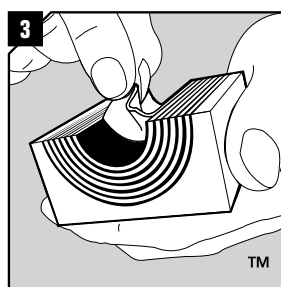

Adapt modules, which are to hold cables or pipes, by peeling off layers until you reach the gap seen in pic. 4. The halves may not differ by more than one layer.

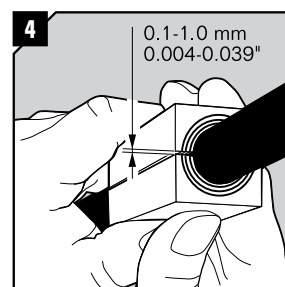

Achieve a 0.1-1.0 mm gap between the two halves when held against the cable/pipe.

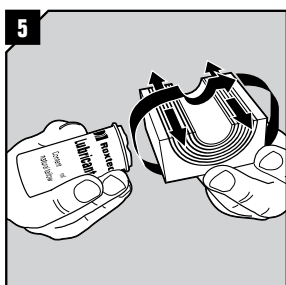

Lubricate all modules for the frame thoroughly, both the inside and the outside surfaces, using Roxtec Lubricant.

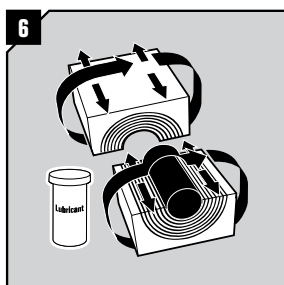

Do not remove the center cores of the spare modules.

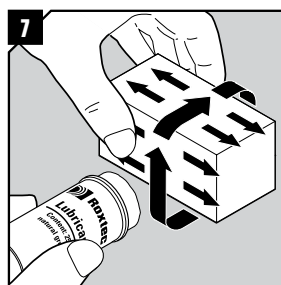

Lubricate solid modules on the sealing surfaces.

r20 installation continued

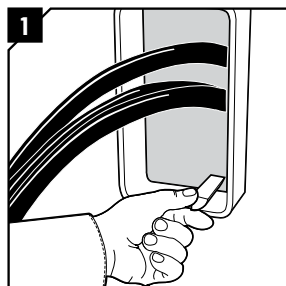

Insert the lubricated RM 20/0 RC modules in the bottom corners.

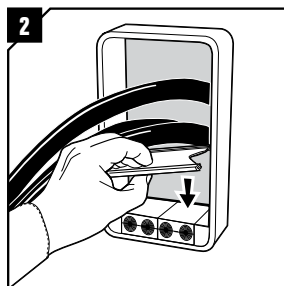

Fill the space between the corner modules with RM 20w40 or RM 20 modules and insert a stayplate on top.

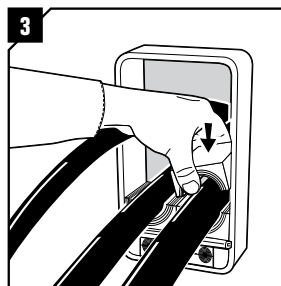

Continue to fill up the packing space of the frame according to your installation plan (transit plan). It is recommended to keep spare modules close to the wedge.

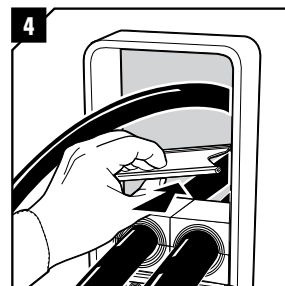

Insert a stayplate on top of every finished row of modules.

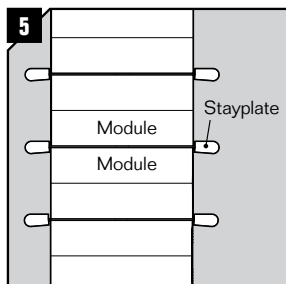

Ensure that the modules are secured within the stayplates edges.

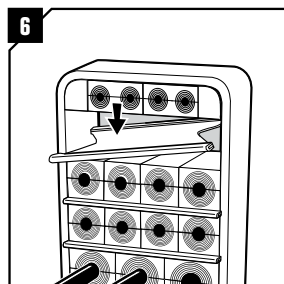

Insert the lubricated RM 20/0 RC modules in the top corners and fill with modules RM 20w40 or RM 20 modules. Install a stayplate. Make room for the wedge at desired position.

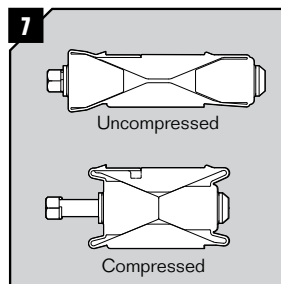

Ensure that the wedge is fully uncompressed by untightening the screws of the wedge before inserting the wedge.

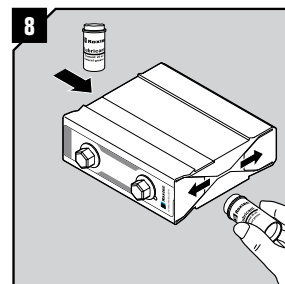

Lubricate the short sides of the wedge.

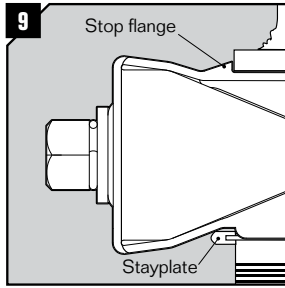

Orientate the wedge so the face marked "Stayplate this side" faces a stayplate. Insert the wedge to the stop flange. Ensure that the wedge is accommodated and secured by the stayplate.

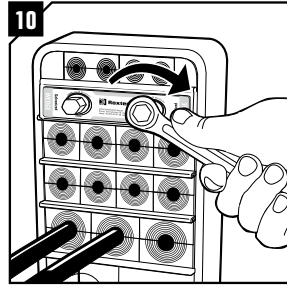

Tighten the screws alternately until full mechanical stop, approx 20 full revolutions per screw. Do not exceed 20 Nm (15 ft.lb.).

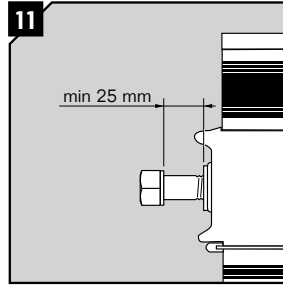

25 mm of the screws shall be exposed.

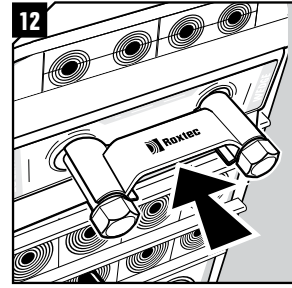

Attach the wedge Clip to the wedge screws to complete the installation.

r40 installation continued

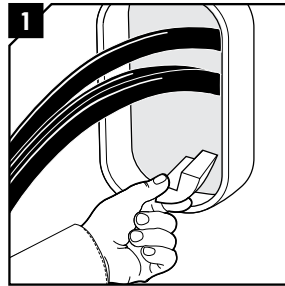

Insert the lubricated RM 40/0 RC modules in the bottom corners.

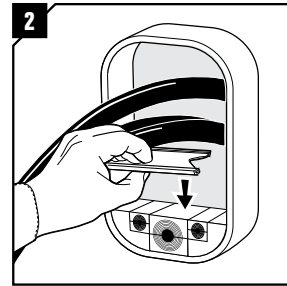

Fill the space between the corner modules with one RM 40 and two RM 20 modules and insert a stayplate on top.

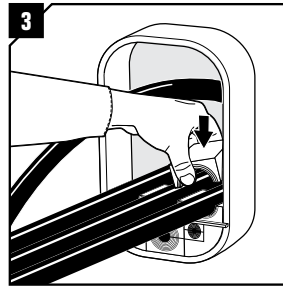

Continue to fill up the packing space of the frame according to your installation plan (transit plan). It is recommended to keep spare modules close to the wedge.

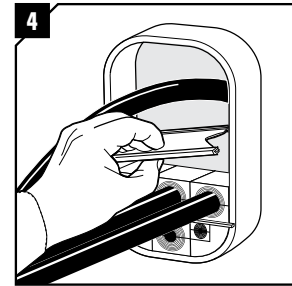

Insert a stayplate on top of every finished row of modules.

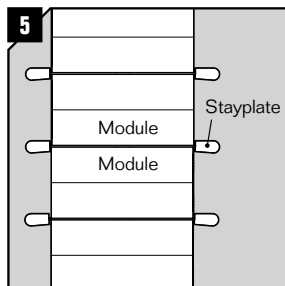

Ensure that the modules are secured within the stayplates edges.

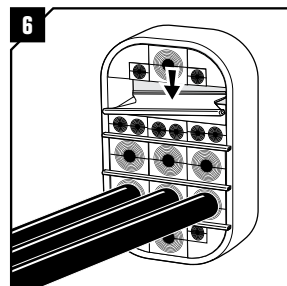

Insert the lubricated RM 40/0 RC modules in the top corners and fill with one RM 40 and two RM 20 modules. Install a stayplate. Make room for the wedge at desired position.

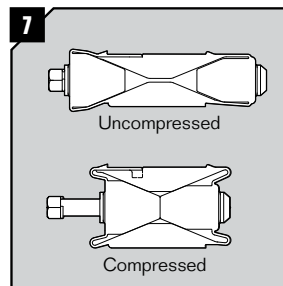

Ensure that the wedge is fully uncompressed by untightening the screws of the wedge before inserting the wedge.

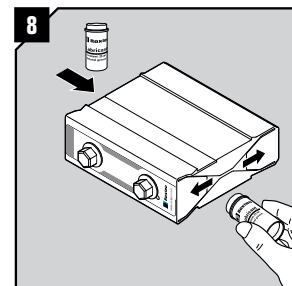

Lubricate the short sides of the wedge.

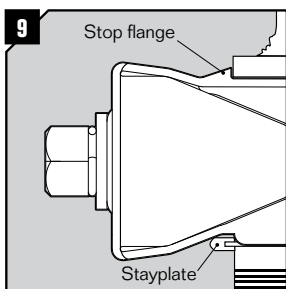

Orientate the wedge so the face marked "Stayplate this side" faces a stayplate. Insert the wedge to the stop flange. Ensure that the wedge is accommodated and secured by the stayplate.

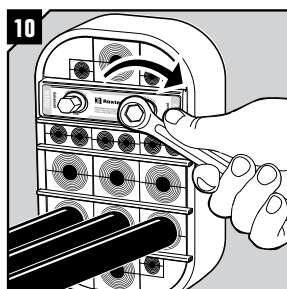

Tighten the screws alternately until full mechanical stop, approx 20 full revolutions per screw. Do not exceed 20 Nm (15 ft.lb.).

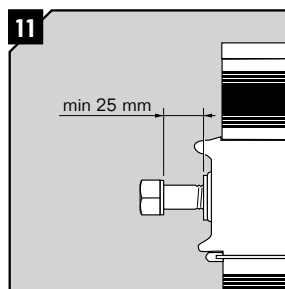

25 mm of the screws shall be exposed.

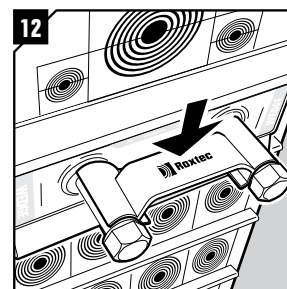

Attach the wedge Clip to the wedge screws to complete the installation.

r60 installation continued

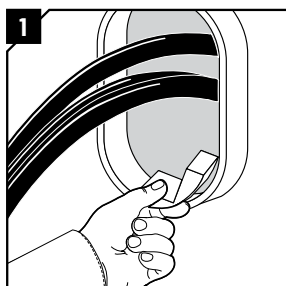

Insert the lubricated RM 60/0 RC modules in the bottom corners.

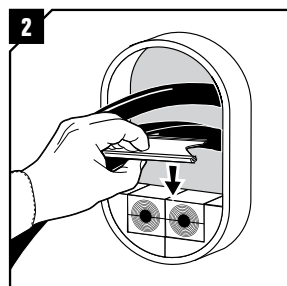

Fill the space between the corner modules with RM 40 modules and insert a stayplate on top.

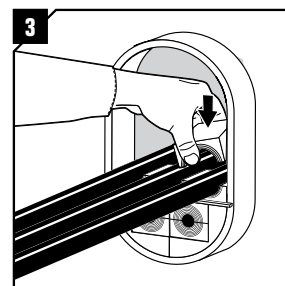

Continue to fill up the packing space of the frame according to your installation plan (transit plan). It is recommended to keep spare modules close to the wedge.

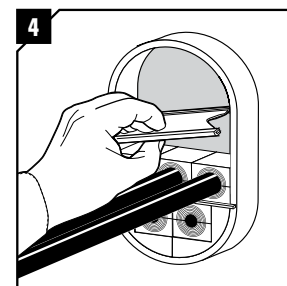

Insert a stayplate on top of every finished row of modules.

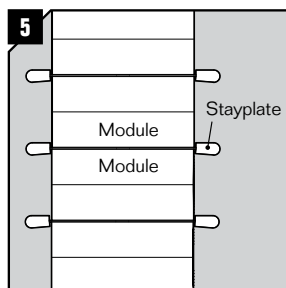

Ensure that the modules are secured within the stayplates' edges.

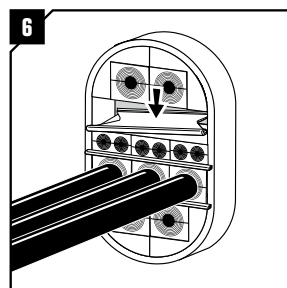

Insert the lubricated RM 60/0 RC modules in the top corners and fill with RM 40 modules. Install a stayplate. Make room for the wedge at desired position.

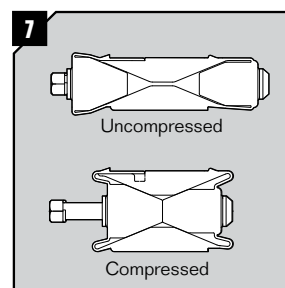

Ensure that the wedge is fully uncompressed by untightening the screws of the wedge before inserting the wedge.

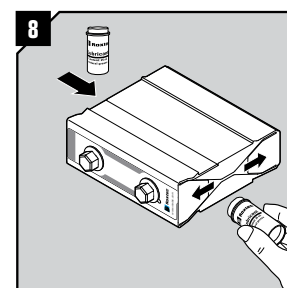

Lubricate the short sides of the wedge.

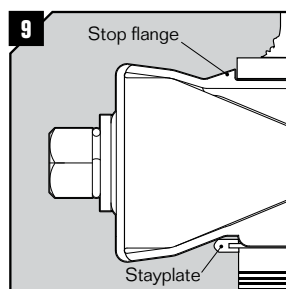

Orientate the wedge so the face marked "Stayplate this side" faces a stayplate. Insert the wedge to the stop flange. Ensure that the wedge is accommodated and secured by the stayplate.

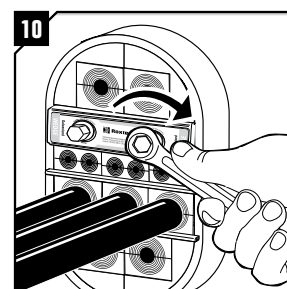

Tighten the screws alternately until full mechanical stop, approx 20 full revolutions per screw. Do not exceed 20 Nm (15 ft.lb.).

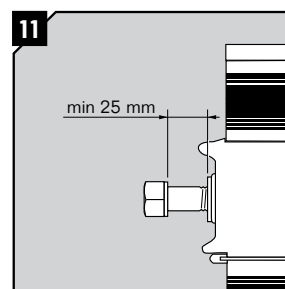

25 mm of the screws shall be exposed.

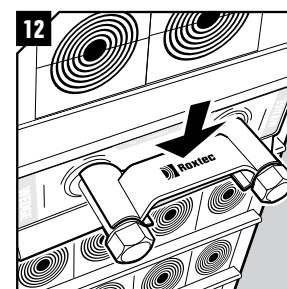

Attach the wedge Clip to the wedge screws to complete the installation.

Disassembly

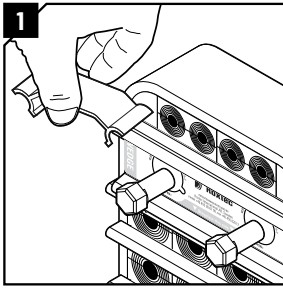

Remove the wedge clip from the wedge.

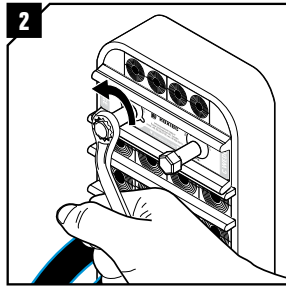

Release the compression by loosen the screws alternately to full stop. Do not exceed 20 Nm (15 ft.lb.).

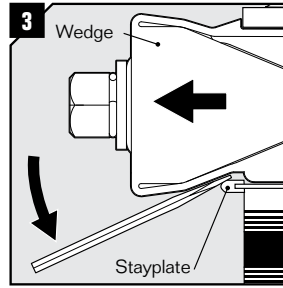

Insert a flat tool between the wedge and the stayplate to simplify removal of the Wedge. Roxtec special tools are available.

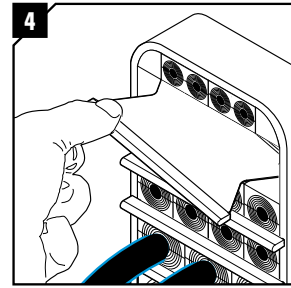

Remove the stayplate.

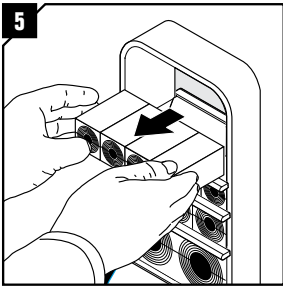

Remove the modules required. Keep the rows sorted until it's time to re-install the transit. If a module is damaged or replaced, all modules in that row must be replaced.

Re-installation

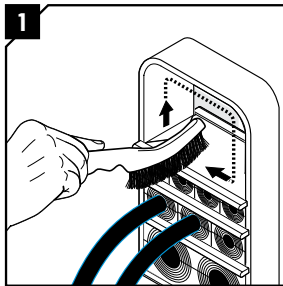

Make sure that the inside surfaces of the exposed packing space are free from dirt or dust.

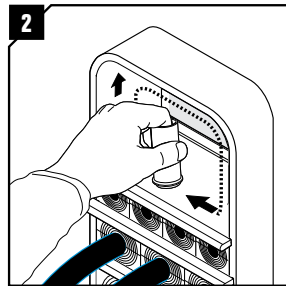

Lubricate the inside surfaces all around with Roxtec Lubricant. Continue the re-installation from step 3, second page.

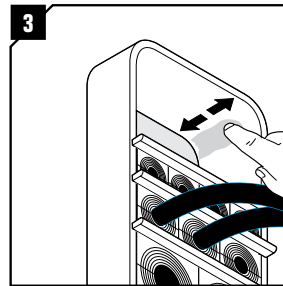

Note

- Wait 24 hours or longer after installation before exposing the cables/pipes to strain or pressure.
- Cables shall go straight through the frame.
- To be used with RM components.
- Ensure that the wedge clip is attached to the wedge bolts.
- Amendments to this installation instruction is available at www.roxtec.com.

DISCLAIMER

"The Roxtec cable entry sealing system ("the Roxtec system") is a modularbased system of sealing products consisting of different components. Each and every one of the components is necessary for the best performance of the Roxtec system. The Roxtec system has been certified to resist a number of different hazards. Any such certification, and the ability of the Roxtec system to resist such hazards, is dependent on all components that are installed as a part of the Roxtec system. Thus, the certification is not valid and does not apply unless all components installed as part of the Roxtec system are manufactured by or under license from Roxtec ("authorized manufacturer"). Roxtec gives no performance guarantee with respect to the Roxtec system, unless (I) all components installed as part of the Roxtec system are manufactured by an authorized manufacturer and (II) the purchaser is in compliance with (a), and (b), below.

(a) During storage, the Roxtec system or part thereof, shall be kept indoors in its original packaging at room temperature.

(b) Installation shall be carried out in accordance with Roxtec installation instructions in effect from time to time.

The product information provided by Roxtec does not release the purchaser of the Roxtec system, or part thereof, from the obligation to independently determine the suitability of the products for the intended process, installation and/or use. Roxtec gives no guarantee for the Roxtec system or any part thereof and assumes no liability for any loss or damage whatsoever, whether direct, indirect, consequential, loss of profit or otherwise, occurred or caused by the Roxtec systems or installations containing components not manufactured by an authorized manufacturer and/or occurred or caused by the use of the Roxtec system in a manner or for an application other than for which the Roxtec system was designed or intended.

Roxtec expressly excludes any implied warranties of merchantability and fitness for a particular purpose and all other express or implied representations and warranties provided by statute or common law. User determines suitability of the Roxtec system for intended use and assumes all risk and liability in connection therewith. In no event shall Roxtec be liable for indirect, consequential, punitive, special, exemplary or incidental damages or losses."

INSTALLATION VIDEO



Roxtec R frame

ALWAYS CHECK OUR LATEST UPDATES

You find the latest versions of our installations instructions on www.roxtec.com. Roxtec can and will not take responsibility for transits that are not installed according to the latest installation instructions.

Installation

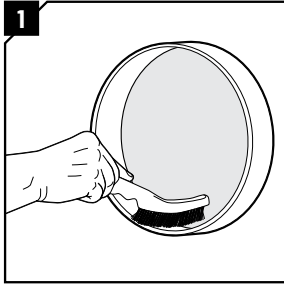

Remove any dirt from the sleeve/hole.

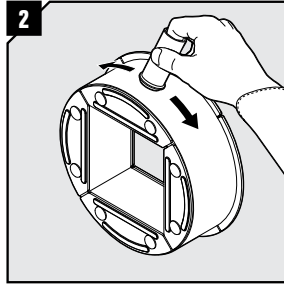

Lubricate the frame sparsely on the outside with Roxtec Lubricant.

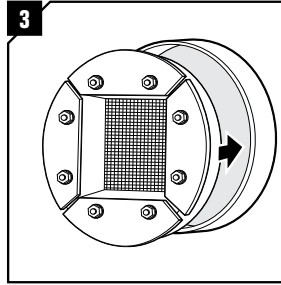

Insert the frame into the sleeve/hole. Please see table "Aperture dimensions".

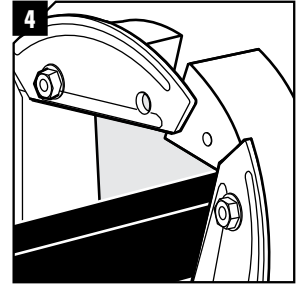

If pipes/cables are pre-routed, an R frame can be cut open with a sharp tool. Cut the longside open between screws. For R100, cut between screw and corner.

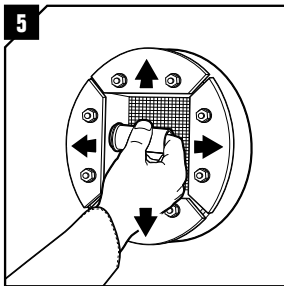

Push the front fittings to the sides. Lubricate the inside of the frame thoroughly, especially into the corners.

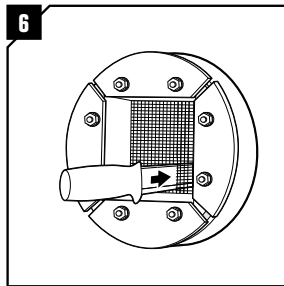

If the frame is provided with a net, cut or bend the net with a sharp tool, or your fingers, to enable cables/pipes to pass through at their position in the frame.

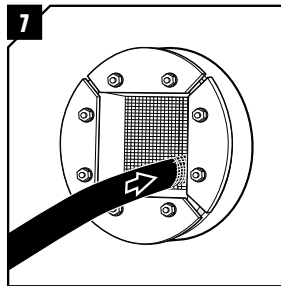

Pull the cables through. Please see note on reverse page.

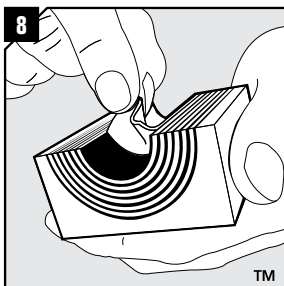

Adapt modules which are to seal cables or pipes by peeling off layers until you reach the gap seen in pic. 9. The halves may not differ by more than one layer.

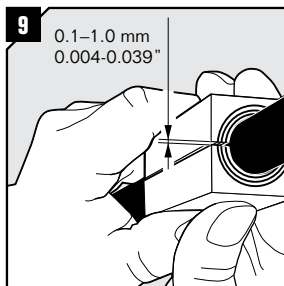

Achieve a 0.1-1.0 mm gap between the two halves when held against the cable/pipe.

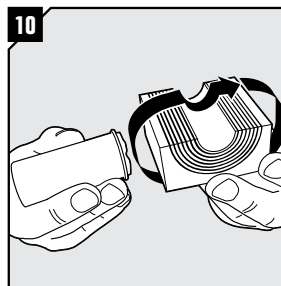

Lubricate all modules for the frame thoroughly, both the inside and the outside surfaces.

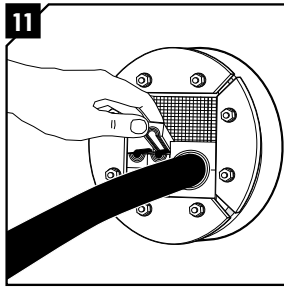

Insert the modules and cables/ pipes according to your installation plan (transit plan).

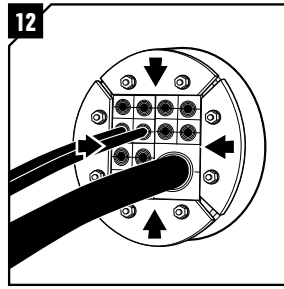

Push the front fittings back towards the center.

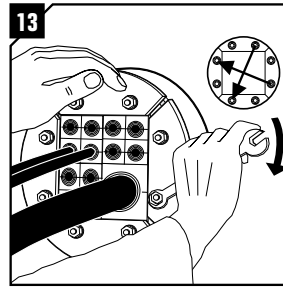

Tighten the nuts crosswise. The frame will compress until it is sealed. Please see recommended torque in the table.

Torque settings

Type:	Rec. torque* (Nm)
R 70-R 127	6-7
R 150-R 200	9-11

* The recommended torque depends on several things, e.g cable or pipe size, amount of used lubricant, sleeve size or material in the cable sheath, etc.

Aperture dimensions

Type:	Aperture Ø (mm)	Clearance depth (mm)	Packing space (mm)
R 70	70-71	75	40 x 40
R 75	75-76	75	40 x 40
R 100	100-102	80	60 x 60
R 125	125-127	75	80 x 80
R 127	127-129	75	80 x 80
R 150	150-152	75	90 x 90
R 200	200-202	75	120 x 120

Disassembly

Reverse order

Note

- For optimum reliability, wait 24 hours or longer after installation before exposing the cables/pipes to strain or pressure.
- To be used with: RM modules.
- Cables/pipes shall be parallel to the sleevehole.
- Cable/pipe with a considerable weight needs to be supported to prevent damage or subsidence to the seal.

DISCLAIMER

"The Roxtec cable entry sealing system ("the Roxtec system") is a modularbased system of sealing products consisting of different components. Each and every one of the components is necessary for the best performance of the Roxtec system. The Roxtec system has been certified to resist a number of different hazards. Any such certification, and the ability of the Roxtec system to resist such hazards, is dependent on all components that are installed as a part of the Roxtec system. Thus, the certification is not valid and does not apply unless all components installed as part of the Roxtec system are manufactured by or under license from Roxtec ("authorized manufacturer"). Roxtec gives no performance guarantee with respect to the Roxtec system, unless (I) all components installed as part of the Roxtec system are manufactured by an authorized manufacturer and (II) the purchaser is in compliance with (a), and (b), below.

(a) During storage, the Roxtec system or part thereof, shall be kept indoors in its original packaging at room temperature.

(b) Installation shall be carried out in accordance with Roxtec installation instructions in effect from time to time.

The product information provided by Roxtec does not release the purchaser of the Roxtec system, or part thereof, from the obligation to independently determine the suitability of the products for the intended process, installation and/or use. Roxtec gives no guarantee for the Roxtec system or any part thereof and assumes no liability for any loss or damage whatsoever, whether direct, indirect, consequential, loss of profit or otherwise, occurred or caused by the Roxtec systems or installations containing components not manufactured by an authorized manufacturer and/or occurred or caused by the use of the Roxtec system in a manner or for an application other than for which the Roxtec system was designed or intended.

Roxtec expressly excludes any implied warranties of merchantability and fitness for a particular purpose and all other express or implied representations and warranties provided by statute or common law. User determines suitability of the Roxtec system for intended use and assumes all risk and liability in connection therewith. In no event shall Roxtec be liable for indirect, consequential, punitive, special, exemplary or incidental damages or losses."

INSTALLATION VIDEO



Roxtec RS seal

ALWAYS CHECK OUR LATEST UPDATES

You find the latest versions of our installations instructions on www.roxtec.com. Roxtec can and will not take responsibility for transits that are not installed according to the latest installation instructions.

Installation Roxtec RS 25-200

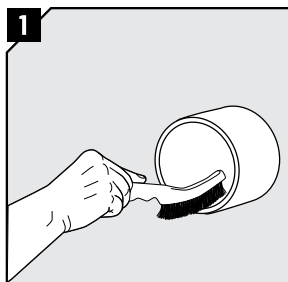

Remove any dirt from the sleeve/hole.

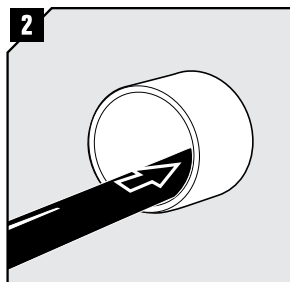

Pull the cable/pipe through. Please see note and table for aperture dimensions.

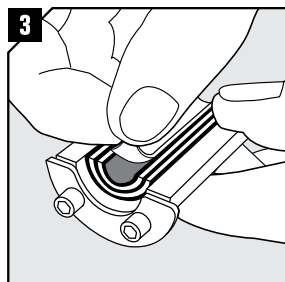

Adapt the seal to the cable/pipe by peeling off layers from the halves until you reach the gap seen in pic.4. The halves may not differ by more than one layer.

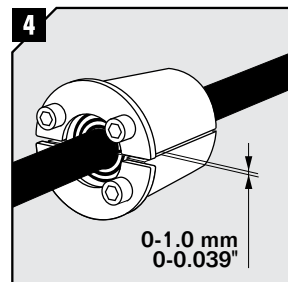

Try to achieve a 0-1.0 mm gap between the two halves when held against the cable/pipe.

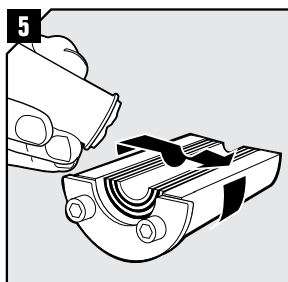

Lubricate thoroughly on the inside surfaces and sparsely on the outside of the seal with Roxtec Lubricant.

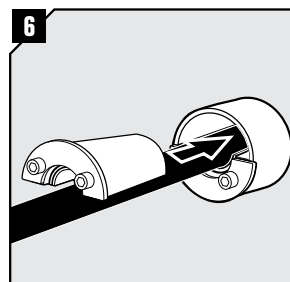

Insert the halves into the sleeve.

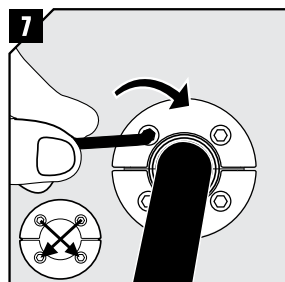

Tighten the screws crosswise. The seal will compress and seal the transit. Please see fig. 1 and 2 for reference.

Tightening torque

Size: RS	Approx. torque* (Nm)
25 - 31	1
43 - 100	4
125 - 200	7

* The recommended torque depends on several things, e.g cable or pipe size, amount of used lubricant, sleeve size or material in the cable sheath.

Fig. 1

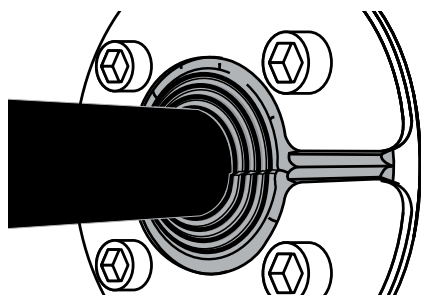

The seal is compressed when rubber expands over the front fittings and the layers bulge outwards.

Fig. 2

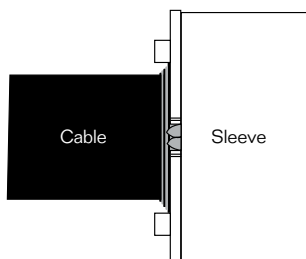

Aperture dimensions

Type:	Aperture Ø (mm)	Clearance depth (mm)
RS 25	25-26	45
RS 31	31-32	45
RS 43	43-45	83
RS 50	50-52	83
RS 68	68-70	83
RS 75	75-77	83
RS 100	100-102	83
RS 125	125-127	83
RS 150	150-152	83
RS 175	175-177	83
RS 200	200-203	83

Installation Roxtec RS 225-644

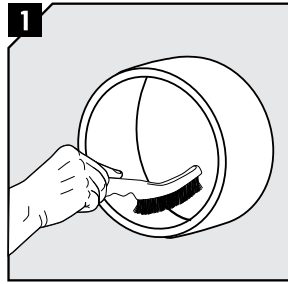

Remove any dirt from the sleeve/hole.

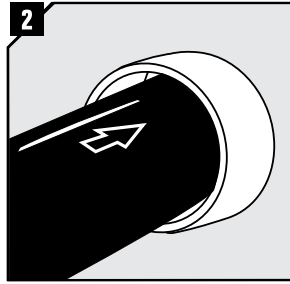

Pull the cable/pipe through. Please see note and table for aperture dimensions.

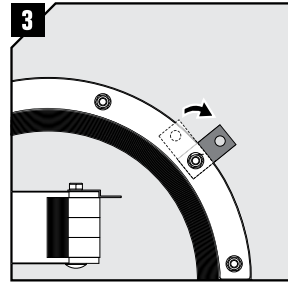

Fold out all stop flanges. Make sure that they are secured by the fittings.

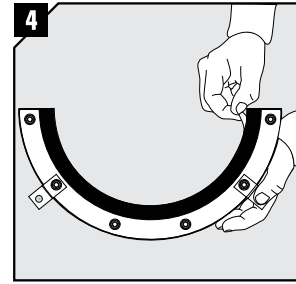

Adapt the seal to the cable/pipe by peeling off layers from the halves until you reach the gap seen in pic.5. The halves may not differ by more than one layer.

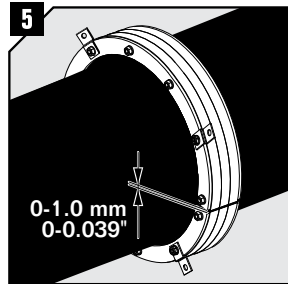

Try to achieve a 0-1.0 mm gap between the two halves when held against the cable/pipe.

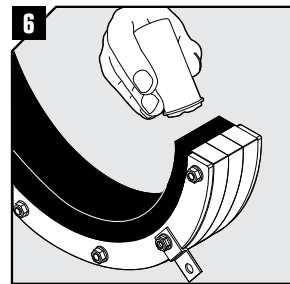

Lubricate thoroughly on the inside surfaces and sparsely on the outside of the seal with Roxtec Lubricant.

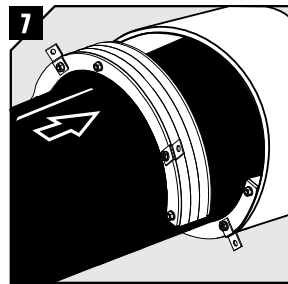

Insert the halves into the sleeve.

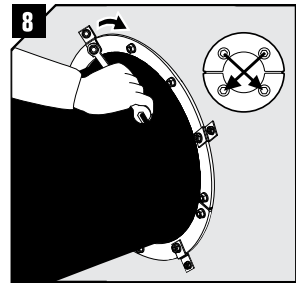

Tighten the bolts crosswise. The seal will compress and seal the transit. Please see table for approx. torque.

Aperture dimensions

Type:	Aperture Ø (mm)	Clearance depth (mm)	Type:	Aperture Ø (mm)	Clearance depth (mm)
RS 225	225-228	75	RS 450	450-453	75
RS 250	250-253	75	RS 500	500-503	75
RS 300	300-303	75	RS 550	550-553	75
RS 350	350-353	75	RS 600	600-603	75
RS 400	400-403	75	RS 644	644-647	75

Tightening torque

Size:	Approx. torque* (Nm)
RS	
225 - 400	17
450 - 644	35

* The recommended torque depends on several things, e.g cable or pipe size, amount of used lubricant, sleeve size or material in the cable sheath.

Disassembly

Reverse order

Note

- Cable/pipe shall be routed perpendicularly to the sleeve or hole.
- Cable/pipe of considerable weight must be supported by surrounding structure or equipment to prevent damage or subsidence to the seal.
- Wait 24 hours or longer after installation before exposing the cables/pipes to strain or pressure.

DISCLAIMER

"The Roxtec cable entry sealing system ("the Roxtec system") is a modularbased system of sealing products consisting of different components. Each and every one of the components is necessary for the best performance of the Roxtec system. The Roxtec system has been certified to resist a number of different hazards. Any such certification, and the ability of the Roxtec system to resist such hazards, is dependent on all components that are installed as a part of the Roxtec system. Thus, the certification is not valid and does not apply unless all components installed as part of the Roxtec system are manufactured by or under license from Roxtec ("authorized manufacturer"). Roxtec gives no performance guarantee with respect to the Roxtec system, unless (I) all components installed as part of the Roxtec system are manufactured by an authorized manufacturer and (II) the purchaser is in compliance with (a), and (b), below.

(a) During storage, the Roxtec system or part thereof, shall be kept indoors in its original packaging at room temperature.

(b) Installation shall be carried out in accordance with Roxtec installation instructions in effect from time to time.

The product information provided by Roxtec does not release the purchaser of the Roxtec system, or part thereof, from the obligation to independently determine the suitability of the products for the intended process, installation and/or use. Roxtec gives no guarantee for the Roxtec system or any part thereof and assumes no liability for any loss or damage whatsoever, whether direct, indirect, consequential, loss of profit or otherwise, occurred or caused by the Roxtec systems or installations containing components not manufactured by an authorized manufacturer and/or occurred or caused by the use of the Roxtec system in a manner or for an application other than for which the Roxtec system was designed or intended.

Roxtec expressly excludes any implied warranties of merchantability and fitness for a particular purpose and all other express or implied representations and warranties provided by statute or common law. User determines suitability of the Roxtec system for intended use and assumes all risk and liability in connection therewith. In no event shall Roxtec be liable for indirect, consequential, punitive, special, exemplary or incidental damages or losses."

INSTALLATION VIDEO



Roxtec SPM™ seal

ALWAYS CHECK OUR LATEST UPDATES

You find the latest versions of our installations instructions on www.roxtec.com. Roxtec can and will not take responsibility for transits that are not installed according to the latest installation instructions.

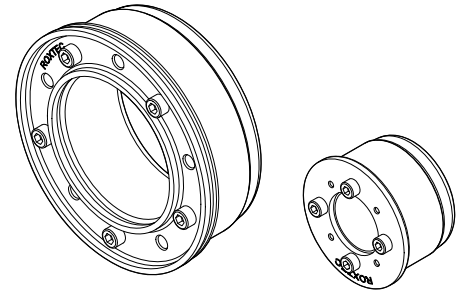

Aperture

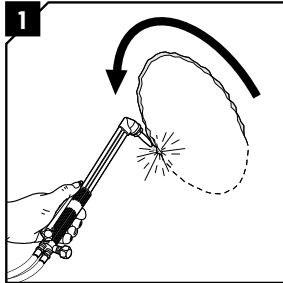

Make an aperture according to the table.

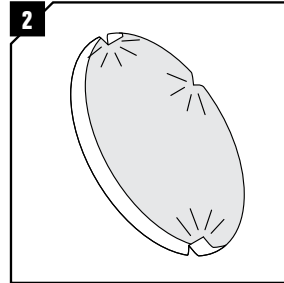

Remove all sharp edges to avoid damage to the rubber of the seal.

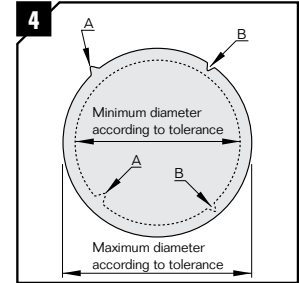
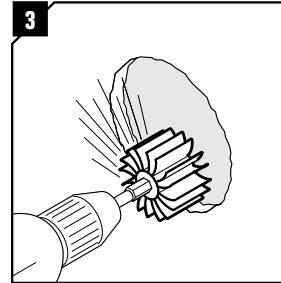

Irregularities are acceptable within the aperture tolerance.
A: Non-acceptable irregularity.
B: Acceptable irregularity.

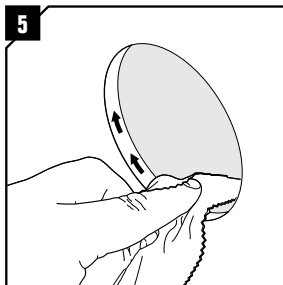

Make sure the aperture is free from dirt and dust.

Aperture dimension and pipe range

Thickness of the structure must be between 6 mm and 15 mm.

SPM seal	Pipe diameter range (mm)	Aperture diameter (mm)	Aperture diameter tolerance + - (mm)	Maximum tightening torque (Nm)
41	12-16	43	2	2
54	19-23	55.5	2	2
59	24-28	60.5	2	3
62	27-31	63.5	2	3
69	32-36	70.5	2	3
81	41.4-45.4	83	2	3
87	47-51	89	2	3
92	52-56	94	2	3
103	56.2-61.1	105	2	7
119	72.2-76.9	121	2	7
138	88-92	140	2	7
157	107-111	159	2	7
168	113-117	170	2	10
196	138.5-143	198	2	10
226	167-171	228	2	10
279	218-222	281	2	10

Installation

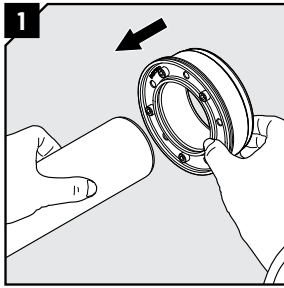

Slide the pipe through the seal.

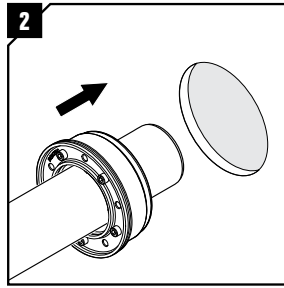

Insert the pipe and seal in the aperture.

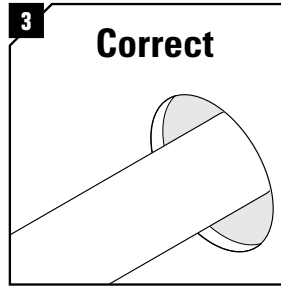

Ensure that the pipe is centrally positioned in the aperture.

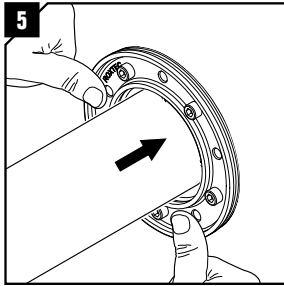
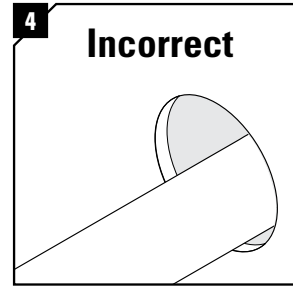

Make sure the seal is properly fitted against the inside of the opening.

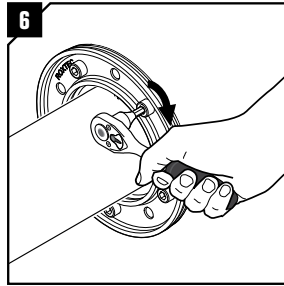

Tighten the bolts crosswise in small steps. Full compression is achieved when the rubber is flush or slightly raised from the steel casing. Do not exceed the maximum torque according to the table on previous page.

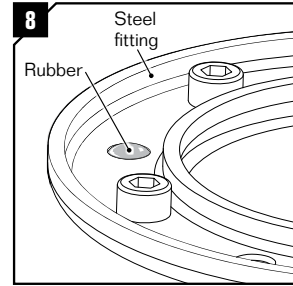
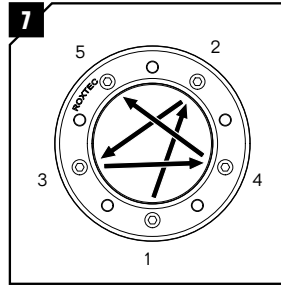

Disassembly

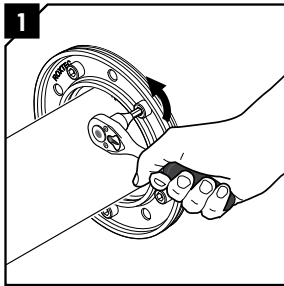

Untighten the bolts crosswise in quarter turn increments.

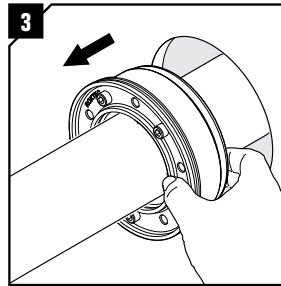
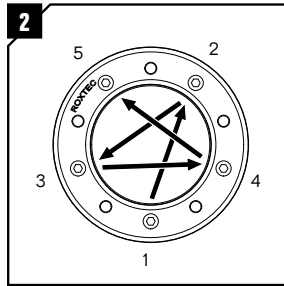

Remove the seal from the opening.

DISCLAIMER

"The Roxtec cable entry sealing system ("the Roxtec system") is a modularbased system of sealing products consisting of different components. Each and every one of the components is necessary for the best performance of the Roxtec system. The Roxtec system has been certified to resist a number of different hazards. Any such certification, and the ability of the Roxtec system to resist such hazards, is dependent on all components that are installed as a part of the Roxtec system. Thus, the certification is not valid and does not apply unless all components installed as part of the Roxtec system are manufactured by or under license from Roxtec ("authorized manufacturer"). Roxtec gives no performance guarantee with respect to the Roxtec system, unless (I) all components installed as part of the Roxtec system are manufactured by an authorized manufacturer and (II) the purchaser is in compliance with (a), and (b), below.

(a) During storage, the Roxtec system or part thereof, shall be kept indoors in its original packaging at room temperature.

(b) Installation shall be carried out in accordance with Roxtec installation instructions in effect from time to time.

The product information provided by Roxtec does not release the purchaser of the Roxtec system, or part thereof, from the obligation to independently determine the suitability of the products for the intended process, installation and/or use. Roxtec gives no guarantee for the Roxtec system or any part thereof and assumes no liability for any loss or damage whatsoever, whether direct, indirect, consequential, loss of profit or otherwise, occurred or caused by the Roxtec systems or installations containing components not manufactured by an authorized manufacturer and/or occurred or caused by the use of the Roxtec system in a manner or for an application other than for which the Roxtec system was designed or intended.

Roxtec expressly excludes any implied warranties of merchantability and fitness for a particular purpose and all other express or implied representations and warranties provided by statute or common law. User determines suitability of the Roxtec system for intended use and assumes all risk and liability in connection therewith. In no event shall Roxtec be liable for indirect, consequential, punitive, special, exemplary or incidental damages or losses."



Roxtec RS PPS back-to-back seal

ALWAYS CHECK OUR LATEST UPDATES

You find the latest versions of our installations instructions on www.roxtec.com. Roxtec can and will not take responsibility for transits that are not installed according to the latest installation instructions.

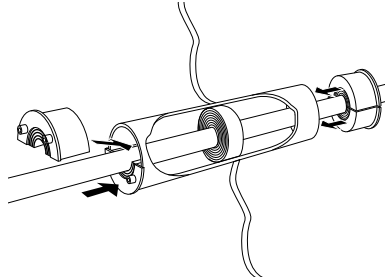

Fig 1: Water tightness or fire rated resistance

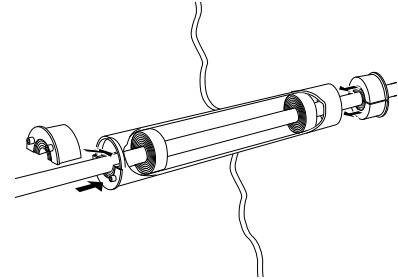
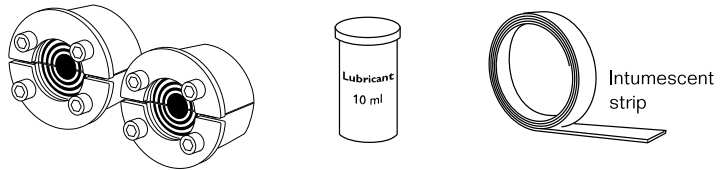
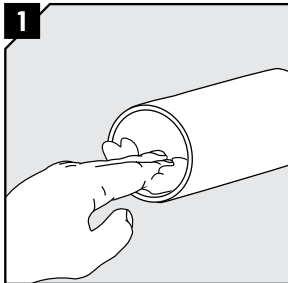

Fig 2: Sustained water tightness after fire exposure



Roxtec Plastic Pipe Seal installation



Remove any dirt inside the sleeve and pull the pipe through.

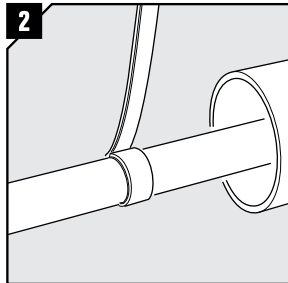

Wrap the intumescent strip once around the pipe without removing the protective tape. This will make it slide better into the sleeve later.

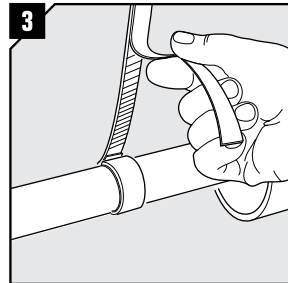

Break the protective tape from the strip and remove it.

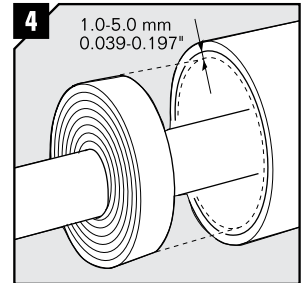

Continue to wrap the strip onto the pipe until there is 1.0-5.0 mm free space left between the strip and sleeve.

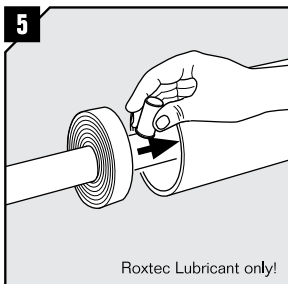

Tip: Lubricate the pipe with Roxtec Lubricant to ease the sliding.

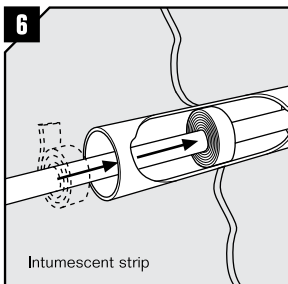

Move/slide the strip into the sleeve and as close to the center as possible. For sustained water tightness after fire exposure applications place one intumescent strip as close as possible to each RS seal according to fig. 2.

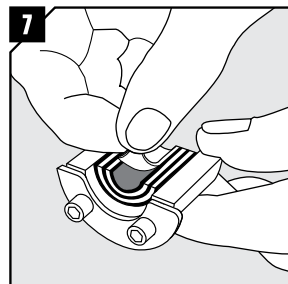

Adapt the seal to the pipe by peeling off layers from the halves until you reach the gap seen in pic.8. The halves may not differ by more than one layer.

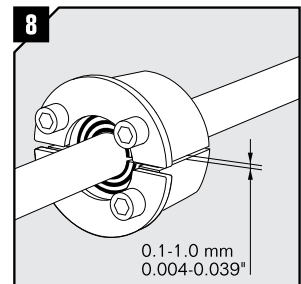

Try to achieve a 0.1-1.0 mm gap between the two halves when held against the pipe.

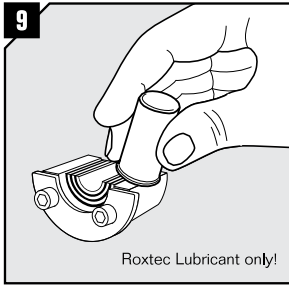

Lubricate thoroughly on the inside surfaces and sparsely on the outside of the seal.

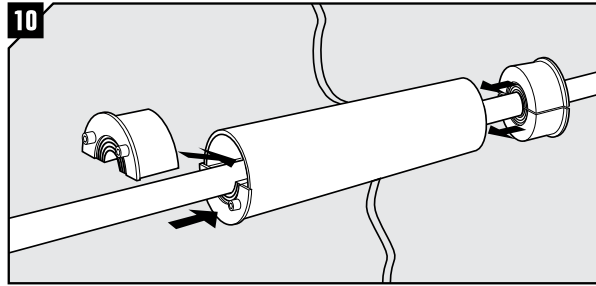

Insert the halves one by one into the sleeve. Make sure the intumescent material stays in the center of the sleeve. For installations having sustained water tightness after fire exposure make sure that the intumescent strips are as close to the RS seals as possible according to fig. 2 at previous page.

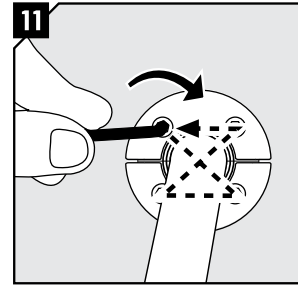

Tighten the screws crosswise. The seal will compress and seal the transit. See table below for recommended torque. See fig. 3 and 4 for reference.

Disassembly

Reverse order

Fig. 3

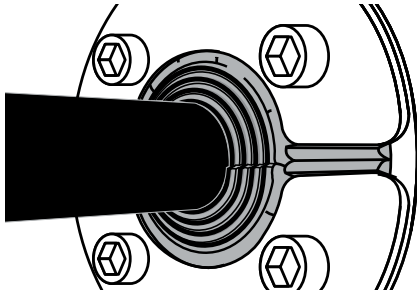
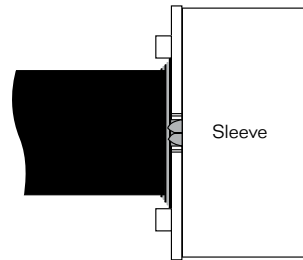

Fig. 4



The seal is compressed when rubber expands over the front fittings and the layers bulge outwards.

Tightening torque

Size: RS PPS	Approx. torque* (Nm)
31	1
43 - 100	4
125 - 200	7
225 - 400	17

* The tightening torque depends on several things, e.g. cable or pipe size, amount of used lubricant, sleeve size or material in the cable sheet, etc.

Note

- Wait 24 hours or longer after installation before exposing the pipe to strain or pressure.
- Pipes shall go straight through the frame.
- Sustained water tightness after fire exposure applications requires a longer sleeve.

DISCLAIMER

"The Roxtec cable entry sealing system ("the Roxtec system") is a modular based system of sealing products consisting of different components. Each and every one of the components is necessary for the best performance of the Roxtec system. The Roxtec system has been certified to resist a number of different hazards. Any such certification, and the ability of the Roxtec system to resist such hazards, is dependent on all components that are installed as a part of the Roxtec system. Thus, the certification is not valid and does not apply unless all components installed as part of the Roxtec system are manufactured by or under license from Roxtec ("authorized manufacturer"). Roxtec gives no performance guarantee with respect to the Roxtec system, unless (I) all components installed as part of the Roxtec system are manufactured by an authorized manufacturer and (II) the purchaser is in compliance with (a), and (b), below.

(a) During storage, the Roxtec system or part thereof, shall be kept indoors in its original packaging at room temperature.

(b) Installation shall be carried out in accordance with Roxtec installation instructions in effect from time to time.

The product information provided by Roxtec does not release the purchaser of the Roxtec system, or part thereof, from the obligation to independently determine the suitability of the products for the intended process, installation and/or use. Roxtec gives no guarantee for the Roxtec system or any part thereof and assumes no liability for any loss or damage whatsoever, whether direct, indirect, consequential, loss of profit or otherwise, occurred or caused by the Roxtec systems or installations containing components not manufactured by an authorized manufacturer and/or occurred or caused by the use of the Roxtec system in a manner or for an application other than for which the Roxtec system was designed or intended.

Roxtec expressly excludes any implied warranties of merchantability and fitness for a particular purpose and all other express or implied representations and warranties provided by statute or common law. User determines suitability of the Roxtec system for intended use and assumes all risk and liability in connection therewith. In no event shall Roxtec be liable for indirect, consequential, punitive, special, exemplary or incidental damages or losses."



Roxtec RS PPS/S single-side seal

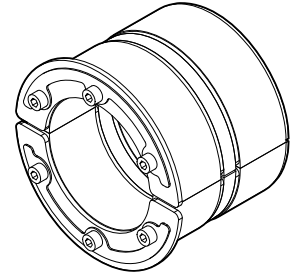

ALWAYS CHECK OUR LATEST UPDATES
 You find the latest versions of our installations instructions on www.roxtec.com.
 Roxtec can and will not take responsibility for transits that are not installed according to the latest installation instructions.

Installation

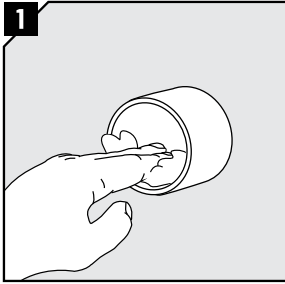

Remove any dirt in the sleeve.

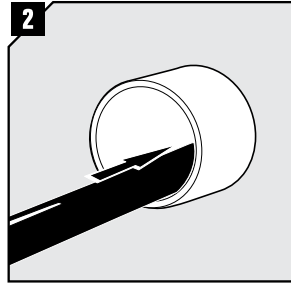

Pull the plastic pipe through.

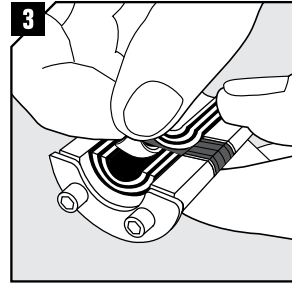

Adapt the seal to the pipe by peeling off layers from the halves until you reach the gap seen in pic.4. The halves may not differ by more than one layer.

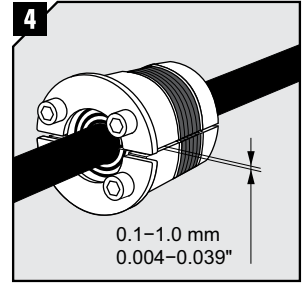

Try to achieve a 0.1-1.0 mm gap between the two halves when held against the pipe.

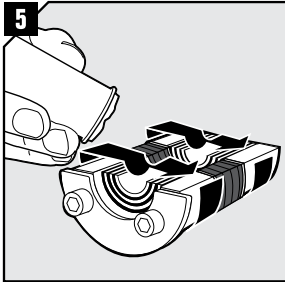

Lubricate thoroughly on the inside and sparsely on the outside of the rubber surfaces of the seal with Roxtec Lubricant. No need to apply lubricant to the grey intumescent material.

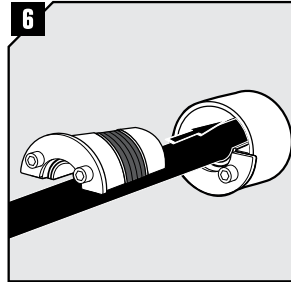

Insert the halves, one by one, into the sleeve.

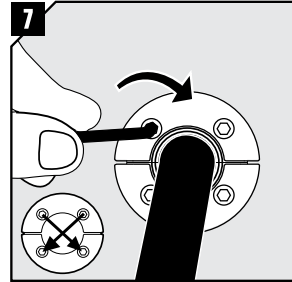

Tighten the screws crosswise. This will compress and seal the RS PPS/S. See table for approx. torque. See fig. 1 and 2 for reference.

Tightening torque

Size: RS PPS/S	Approx. torque* (Nm)
25 - 31	1
43 - 100	4
125 - 150	7

* The tightening torque depends on several things, e.g cable or pipe size, amount of used lubricant, sleeve size or material in the cable sheath.

Fig. 1

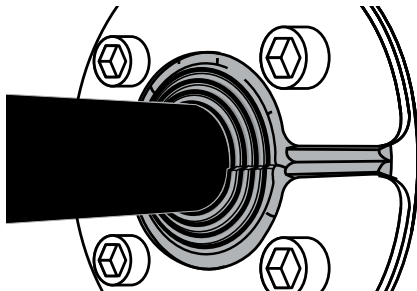
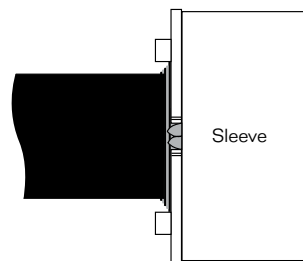

Fig. 2



The seal is compressed when rubber expands over the front fittings and the layers bulge outwards.

Sustained water tightness after fire exposure

RS PPS/S Seals mounted back to back in a longer sleeve

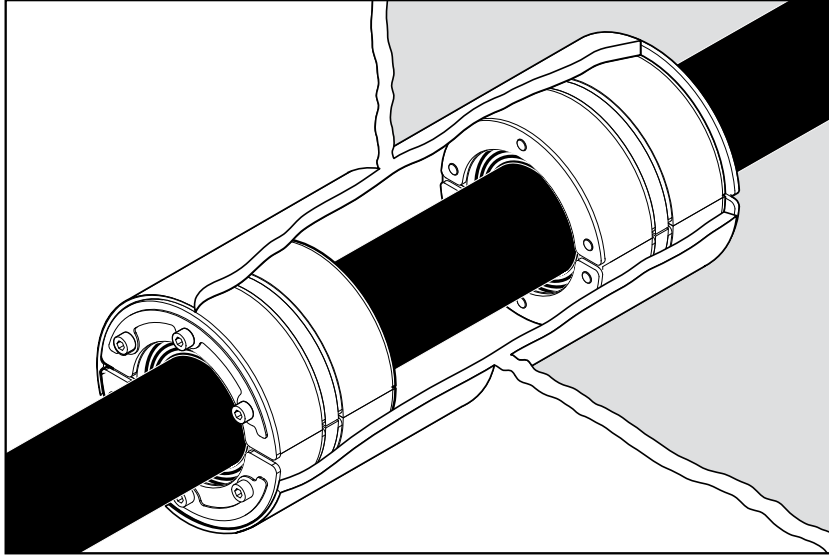

Disassembly

Reverse order

Aperture dimensions

Type:	Aperture Ø (mm)	Clearance depth (mm)
RS 25 PPS/S	25-26	45
RS 31 PPS/S	31-32	45
RS 43 PPS/S	43-45	83
RS 50 PPS/S	50-52	83
RS 68 PPS/S	68-70	83
RS 75 PPS/S	75-77	83
RS 100 PPS/S	100-102	83
RS 125 PPS/S	125-127	83
RS 150 PPS/S	150-152	83

Note

- Wait 24 hours or longer after installation before exposing the pipe to strain or pressure.
- Install pipes straight through the seal.
- Sustained water tightness after fire exposure applications requires a longer sleeve.

DISCLAIMER

"The Roxtec cable entry sealing system ("the Roxtec system") is a modular based system of sealing products consisting of different components. Each and every one of the components is necessary for the best performance of the Roxtec system. The Roxtec system has been certified to resist a number of different hazards. Any such certification, and the ability of the Roxtec system to resist such hazards, is dependent on all components that are installed as a part of the Roxtec system. Thus, the certification is not valid and does not apply unless all components installed as part of the Roxtec system are manufactured by or under license from Roxtec ("authorized manufacturer"). Roxtec gives no performance guarantee with respect to the Roxtec system, unless (I) all components installed as part of the Roxtec system are manufactured by an authorized manufacturer and (II) the purchaser is in compliance with (a), and (b), below.

(a) During storage, the Roxtec system or part thereof, shall be kept indoors in its original packaging at room temperature.

(b) Installation shall be carried out in accordance with Roxtec installation instructions in effect from time to time.

The product information provided by Roxtec does not release the purchaser of the Roxtec system, or part thereof, from the obligation to independently determine the suitability of the products for the intended process, installation and/or use. Roxtec gives no guarantee for the Roxtec system or any part thereof and assumes no liability for any loss or damage whatsoever, whether direct, indirect, consequential, loss of profit or otherwise, occurred or caused by the Roxtec systems or installations containing components not manufactured by an authorized manufacturer and/or occurred or caused by the use of the Roxtec system in a manner or for an application other than for which the Roxtec system was designed or intended.

Roxtec expressly excludes any implied warranties of merchantability and fitness for a particular purpose and all other express or implied representations and warranties provided by statute or common law. User determines suitability of the Roxtec system for intended use and assumes all risk and liability in connection therewith. In no event shall Roxtec be liable for indirect, consequential, punitive, special, exemplary or incidental damages or losses."

Roxtec ComSeal™

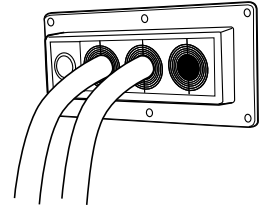

ALWAYS CHECK OUR LATEST UPDATES

You find the latest versions of our installations instructions on www.roxtec.com.
Roxtec can and will not take responsibility for transits that are not installed according to the latest installation instructions.

Aperture dimensions

ComSeal™ 10

	max R10 (4x) (R0.394" (4x))	
	(mm)	(in)
H	149±1	5.866±0.039
W	56±1	2.205±0.039
a	68.5±0.5	2.697±0.020
b	80.5±0.5	3.170±0.020
c	6.25±1	0.246±0.039
d	6±1	0.236±0.039

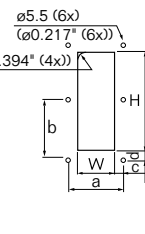

ComSeal™ 12

	max R10 (4x) (R0.394" (4x))	
	(mm)	(in)
H	169±1	6.654±0.039
W	56±1	2.205±0.039
a	62±0.5	2.441±0.020
b	193±0.5	7.598±0.020
c	3±1	0.118±0.039
d	12±1	0.472±0.039

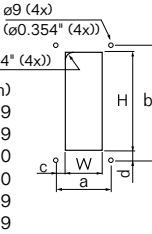

ComSeal™ 15

	max R5 (4x) (R0.197" (4x))	
	(mm)	(in)
H	195±1	7.677±0.039
W	61±1	2.402±0.039
a	78.5±0.5	3.091±0.020
b	105.5±0.5	4.154±0.020
c	9±1	0.354±0.039
d	8±1	0.315±0.039

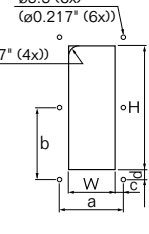

ComSeal™ 16

	max R10 (4x) (R0.394" (4x))	
	(mm)	(in)
H	209±1	8.228±0.039
W	56±1	2.204±0.039
a	68.5±0.5	2.697±0.020
b	73.7±0.5	2.901±0.020
c	6.25±1	0.246±0.039
d	6±1	0.236±0.039

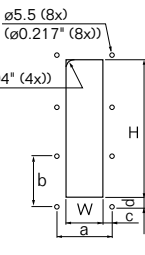

ComSeal™ 30

	max R5 (4x) (R0.197" (4x))	
	(mm)	(in)
H	195±1	7.677±0.039
W	120±1	4.724±0.039
a	71.5±0.5	2.815±0.020
b	109.5±1	4.311±0.039
c	11±1	0.433±0.039
d	12±1	0.472±0.039

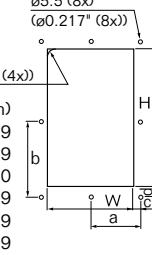

ComSeal™ 32

	max R10 (4x) (R0.394" (4x))	
	(mm)	(in)
H	209±1	8.228±0.039
W	103±1	4.055±0.039
a	61.5±0.5	2.421±0.020
b	76.3±1	3.005±0.039
c	10±1	0.394±0.039
d	10±1	0.394±0.039

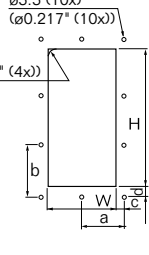

Cut a rectangular opening for the frame, according to the tables above. For Roxtec ComSeal™ 12 cut a rectangular opening according to FL 21 or the table above.
Use a counter flange with Roxtec ComSeal™ 12 (article no. 2CV0001020219) if the wall structure is thinner than 2 mm.

Installation

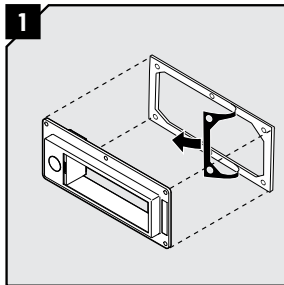

Remove the protective foil from the gasket. Decide which side of the flange that is to face the wall/structure and fasten the gasket on it.

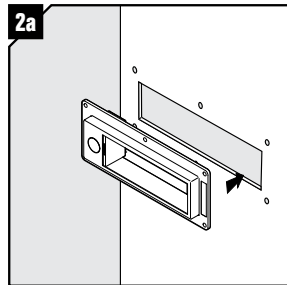

Insert the frame in the opening with gasket side towards the wall/structure.

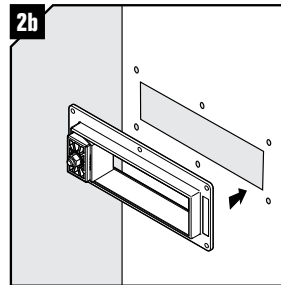

Alternatively, insert it with the other side of the flange and gasket facing the wall/structure.

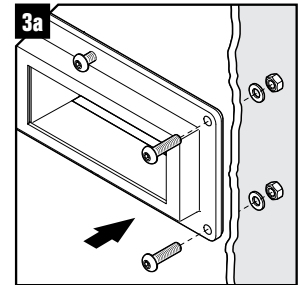

Attach the frame firmly, using the enclosed screws, washers and nuts.

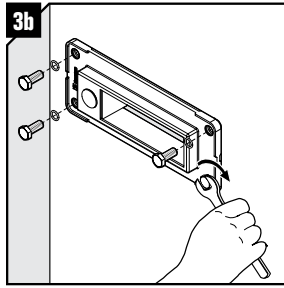

For ComSeal 12, attach the frame firmly, using the enclosed screws, nuts, o-rings and washers.

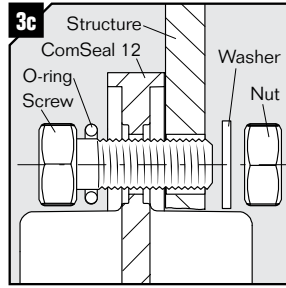

For ComSeal 12, make sure that the o-ring is mounted under the bolt head.

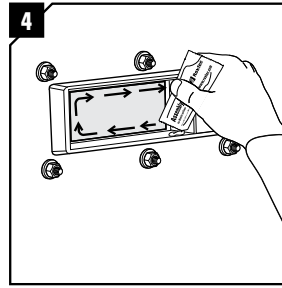

Lubricate the inside surfaces of the frame with Roxtec Assembly Gel, especially in the corners.

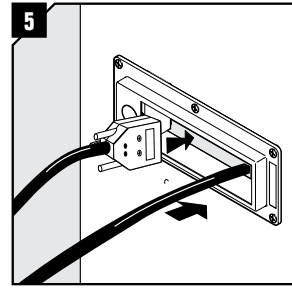

Insert the cables through the frame.

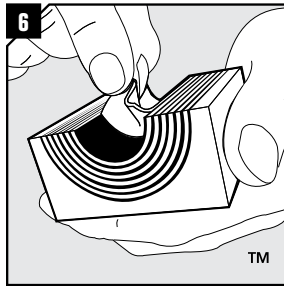

Adapt the modules, which are to hold cables or pipes. Peel off layers until you achieve the gap seen in pic. 7. The halves may not differ by more than one layer.

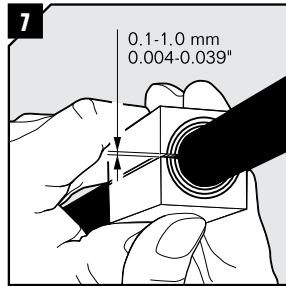

Achieve a 0.1-1.0 mm gap between the two module halves when held against the cable/pipe.

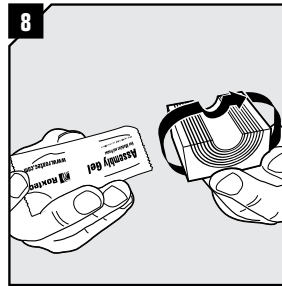

Lubricate all modules thoroughly, both on the inside and the outside surfaces, before installation.

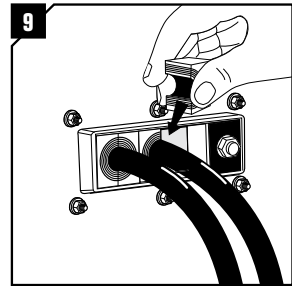

Insert the modules from the back of the frame opening and according to the installation plan (Packing plan). If possible, start with the largest modules.

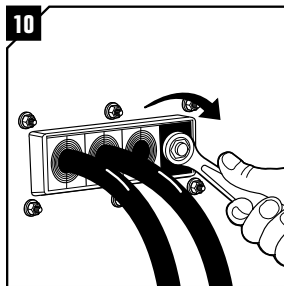

Tighten the compression unit firmly to seal the frame. Maximum 10 Nm (7.38 ft. lb). A good indication is when the assembly gel is squeezed out between the modules.

Disassembly

Reverse order.

Note

- For optimum reliability, wait 24 hours or longer after installation before exposing the cables/pipes to strain or pressure.
- To be used together with CM modules.
- To simplify installation of Roxtec ComSeal™ 30 and 32, it is recommended to fill both openings before tightening the compression units.
- Cables shall go straight through the frame.

DISCLAIMER

"The Roxtec cable entry sealing system ("the Roxtec system") is a modular based system of sealing products consisting of different components. Each and every one of the components is necessary for the best performance of the Roxtec system. The Roxtec system has been certified to resist a number of different hazards. Any such certification, and the ability of the Roxtec system to resist such hazards, is dependent on all components that are installed as a part of the Roxtec system. Thus, the certification is not valid and does not apply unless all components installed as part of the Roxtec system are manufactured by or under license from Roxtec ("authorized manufacturer"). Roxtec gives no performance guarantee with respect to the Roxtec system, unless (i) all components installed as part of the Roxtec system are manufactured by an authorized manufacturer and (ii) the purchaser is in compliance with (a), and (b), below.

(a) During storage, the Roxtec system or part thereof, shall be kept indoors in its original packaging at room temperature.
 (b) Installation shall be carried out in accordance with Roxtec installation instructions in effect from time to time.

The product information provided by Roxtec does not release the purchaser of the Roxtec system, or part thereof, from the obligation to independently determine the suitability of the products for the intended process, installation and/or use. Roxtec gives no guarantee for the Roxtec system or any part thereof and assumes no liability for any loss or damage whatsoever, whether direct, indirect, consequential, loss of profit or otherwise, occurred or caused by the Roxtec systems or installations containing components not manufactured by an authorized manufacturer and/or occurred or caused by the use of the Roxtec system in a manner or for an application other than for which the Roxtec system was designed or intended.

Roxtec expressly excludes any implied warranties of merchantability and fitness for a particular purpose and all other express or implied representations and warranties provided by statute or common law. User determines suitability of the Roxtec system for intended use and assumes all risk and liability in connection therewith. In no event shall Roxtec be liable for indirect, consequential, punitive, special, exemplary or incidental damages or losses."



Roxtec CF 8, CF 32 frames

ALWAYS CHECK OUR LATEST UPDATES

You find the latest versions of our installations instructions on www.roxtec.com. Roxtec can and will not take responsibility for transits that are not installed according to the latest installation instructions.

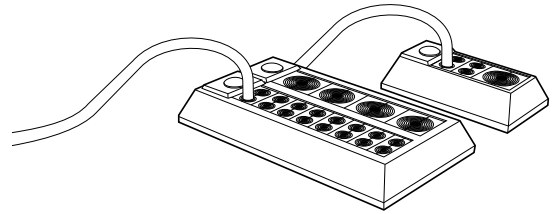

Aperture dimensions

CF 8

Hole dimensions in cabinet:

	(mm)	(in)
H	127±0.5	5.000±0.02
W	61±0.5	2.402±0.02

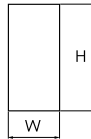

Max wall/cabinet thickness: 4 mm (0.157")

CF 32

Hole dimensions in cabinet:

	(mm)	(in)
H	216±0.5	8.504±0.02
W	110±0.5	4.331±0.02

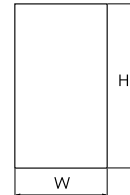

Max wall/cabinet thickness: 4 mm (0.157")

Cut a rectangular opening in the cabinet according to above tables.

Installation

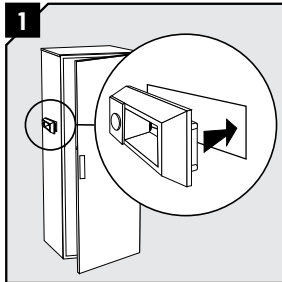

Insert the CF frame from the outside of the cabinet.

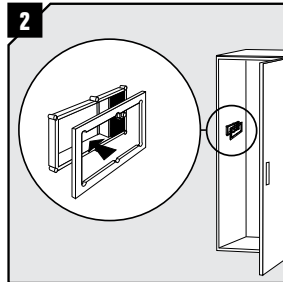

Insert the counter frame from the inside of the cabinet.

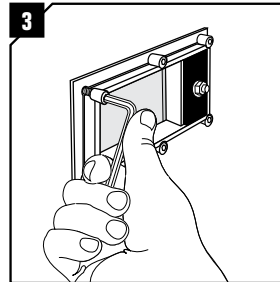

Fasten the hexagon nuts on the backside.

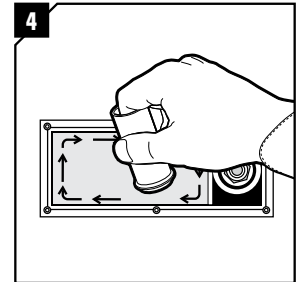

Lubricate the inside surfaces of the frame with Roxtec Lubricant, especially into the corners.

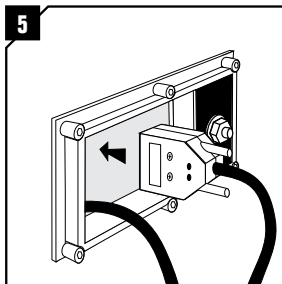

Insert the cables/pipes through the frame.

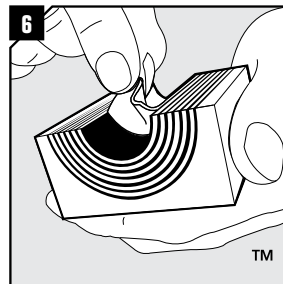

Adapt modules which are to hold cables or pipes by peeling off layers until you reach the gap seen in pic. 7. The halves may not differ by more than one layer.

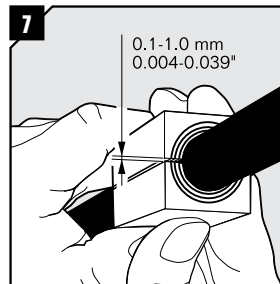

Achieve a 0.1-1.0 mm gap between the two halves when held against the cable/pipe.

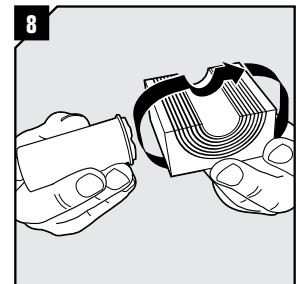

Lubricate all modules for the frame thoroughly, both the inside and the outside surfaces.

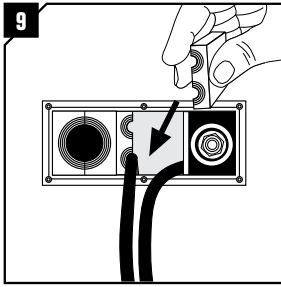

Insert the modules according to your installation plan (transit plan). Start with the largest modules.

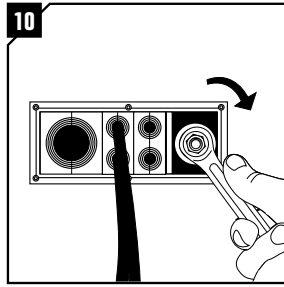

Tighten the compression unit to seal the frame. Recommended torque 8-12 Nm.

Disassembly

Reverse order

Note

- For optimum reliability, wait 24 hours or longer after installation before exposing the cables/pipes to strain or pressure.
- To be used with: CM components.
- Cables shall go straight through the frame.

DISCLAIMER

"The Roxtec cable entry sealing system ("the Roxtec system") is a modularbased system of sealing products consisting of different components. Each and every one of the components is necessary for the best performance of the Roxtec system. The Roxtec system has been certified to resist a number of different hazards. Any such certification, and the ability of the Roxtec system to resist such hazards, is dependent on all components that are installed as a part of the Roxtec system. Thus, the certification is not valid and does not apply unless all components installed as part of the Roxtec system are manufactured by or under license from Roxtec ("authorized manufacturer"). Roxtec gives no performance guarantee with respect to the Roxtec system, unless (I) all components installed as part of the Roxtec system are manufactured by an authorized manufacturer and (II) the purchaser is in compliance with (a), and (b), below.

(a) During storage, the Roxtec system or part thereof, shall be kept indoors in its original packaging at room temperature.

(b) Installation shall be carried out in accordance with Roxtec installation instructions in effect from time to time.

The product information provided by Roxtec does not release the purchaser of the Roxtec system, or part thereof, from the obligation to independently determine the suitability of the products for the intended process, installation and/or use. Roxtec gives no guarantee for the Roxtec system or any part thereof and assumes no liability for any loss or damage whatsoever, whether direct, indirect, consequential, loss of profit or otherwise, occurred or caused by the Roxtec systems or installations containing components not manufactured by an authorized manufacturer and/or occurred or caused by the use of the Roxtec system in a manner or for an application other than for which the Roxtec system was designed or intended.

Roxtec expressly excludes any implied warranties of merchantability and fitness for a particular purpose and all other express or implied representations and warranties provided by statute or common law. User determines suitability of the Roxtec system for intended use and assumes all risk and liability in connection therewith. In no event shall Roxtec be liable for indirect, consequential, punitive, special, exemplary or incidental damages or losses."



Roxtec Sleeve-it™ Fire penetration seal

ALWAYS CHECK OUR LATEST UPDATES

You find the latest versions of our installations instructions on www.roxtec.com. Roxtec can and will not take responsibility for transits that are not installed according to the latest installation instructions.

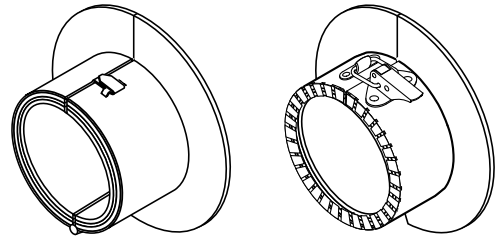

Aperture dimensions

Type:	Pipe outer diam Ø (mm)	Recommended aperture ØD (mm)	Art. no
SLEEVE-IT FC - MAR16M	16	22 +/-4	106239
SLEEVE-IT FC - MAR20M	20	26 +/-4	106245
SLEEVE-IT FC - MAR25M	25	31 +/-4	106247
SLEEVE-IT FC - MAR32M	32	38 +/-4	106249
SLEEVE-IT FC - MAR40M	40	46 +/-4	106251
SLEEVE-IT FC - MAR50M (1.5")	48.3	54 +/-4	106253
SLEEVE-IT FC - MAR60M (2")	60.3	66 +/-4	106255
SLEEVE-IT FC - MAR63M	63	69 +/-4	106257
SLEEVE-IT FC - MAR66M	66	72 +/-4	117916
SLEEVE-IT FC - MAR75M	75	81 +/-4	106259
SLEEVE-IT FC - MAR82M	82	88 +/-4	117919
SLEEVE-IT FC - MAR90M (3")	88.9	95 +/-4	106261
SLEEVE-IT FC - MAR110M	110	116 +/-4	106263
SLEEVE-IT FC - MAR115M (4")	114.3	120 +/-4	106265
SLEEVE-IT FC - MAR125M	125	131 +/-4	106267
SLEEVE-IT FC - MAR140M	140	146 +/-4	106269
SLEEVE-IT FC - MAR160M	160	166 +/-4	106271
SLEEVE-IT FC - MAR169M (6")	168.3	174 +/-4	106273
SLEEVE-IT FC - MAR200M	200	206 +/-4	106275
SLEEVE-IT FC - MAR219M (8")	219.1	225 +/-4	106278
SLEEVE-IT FC - MAR225M	225	231 +/-4	106280

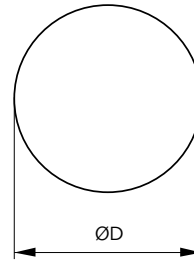

Installation

Pre-routed pipe.

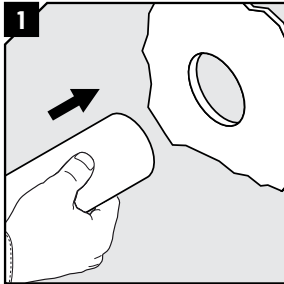

1 Route the pipe through the aperture.

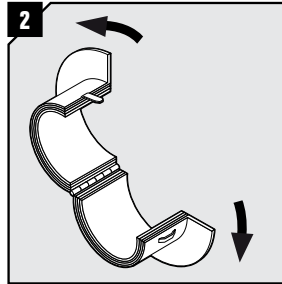

2 Open the fire penetration seal.

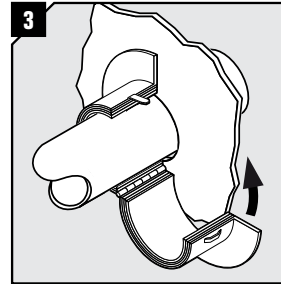

3 Apply the fire penetration seal onto the pipe.

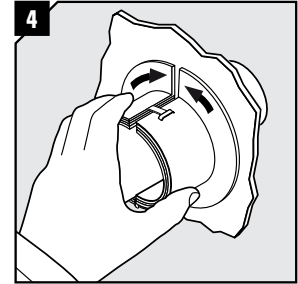

4 Close the fire penetration seal.

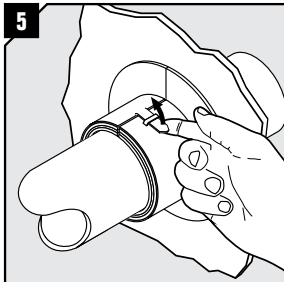

5 Lock the fire penetration seal by pulling the tab over.

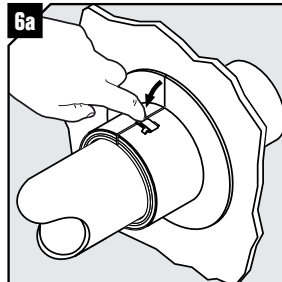

6a Fire penetration seal locked (for smaller sizes).

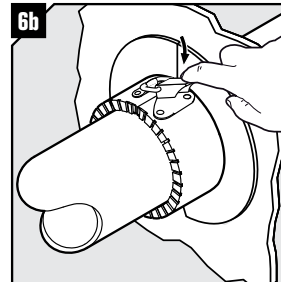

6b Push down the lever to lock the fastener (for larger sizes).

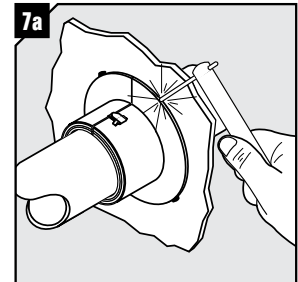

7a Tack weld the fire penetration seal to the structure. Minimum 4 positions.

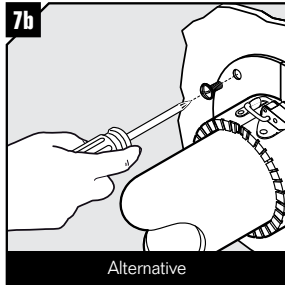

7b
Alternative
Drill holes in the flange and bolt the fire penetration seal to the structure. Minimum 4 positions.

Installation

Non pre-routed pipe.

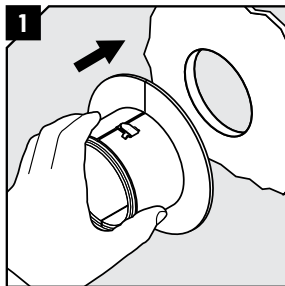

1
Locate and align the closed and locked fire penetration seal with the aperture.

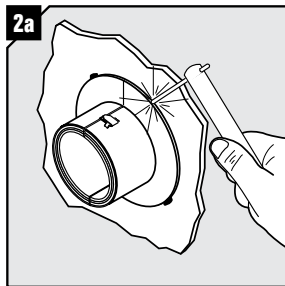

2a
Tack weld the fire penetration seal to the structure. Minimum 4 positions.

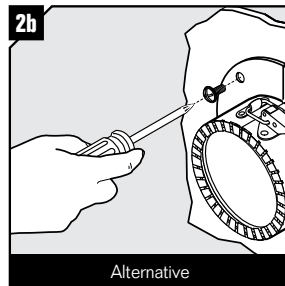

2b
Alternative
Drill holes in the flange and bolt the fire penetration seal to the structure. Minimum 4 positions.

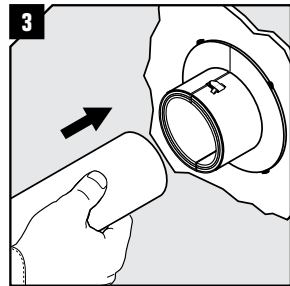

3
Route the pipe through the aperture and fire penetration seal.

Installation

Pre-routed multiple pipes.

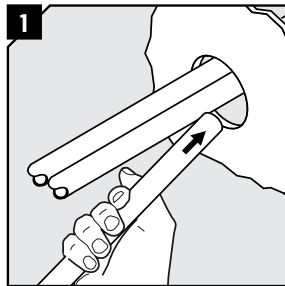

1
Route the pipes through the aperture.

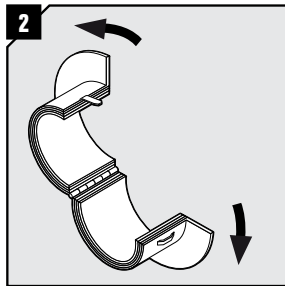

2
Open the fire penetration seal.

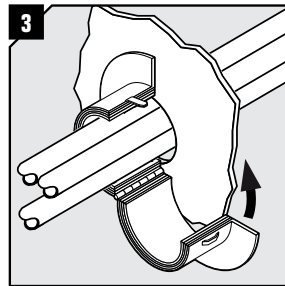

3
Apply the fire penetration seal onto the pipes.

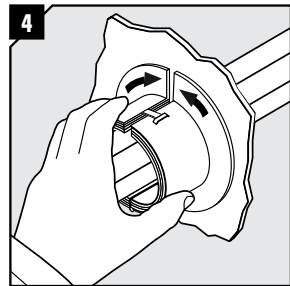

4
Lock the fire penetration seal.

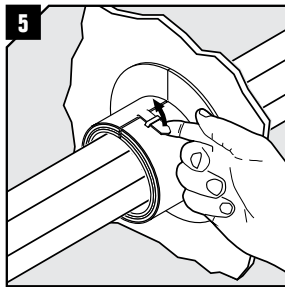

5
Lock the fire penetration seal by pulling the tab over.

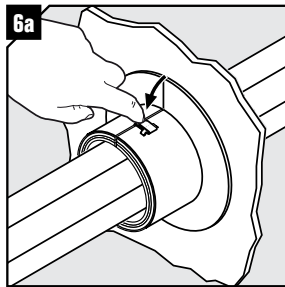

6a
Fire penetration seal locked (for smaller sizes).

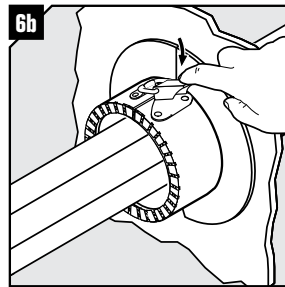

6b
Fire penetration seal locked (for larger sizes).

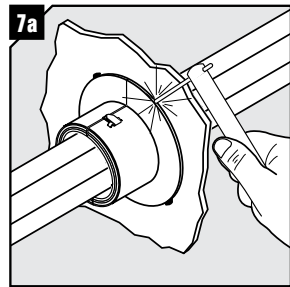

7a
Tack weld the fire penetration seal to the structure. Minimum 4 positions.

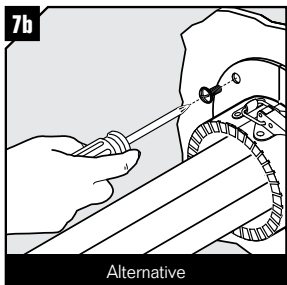

Drill holes in the flange and bolt the fire penetration seal to the structure. Minimum 4 positions.

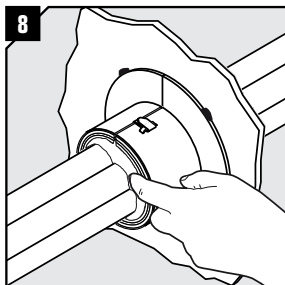

Fill the void between the pipes and the inside of the fire penetration seal with Roxtec smoke seal putty. Smooth the surface of the putty.

Installation

Non pre-routed multiple pipes.

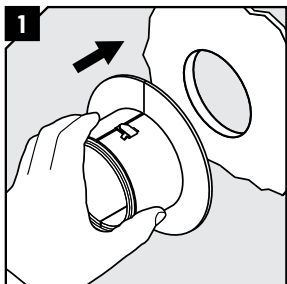

Locate and align the closed and locked fire penetration seal with the aperture.

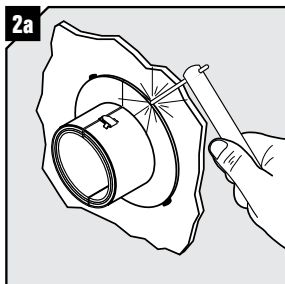

Tack weld the fire penetration seal to the structure. Minimum 4 positions.

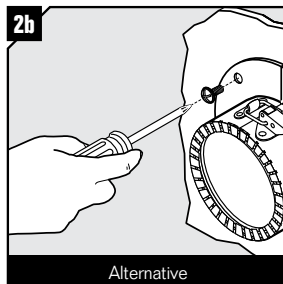

Drill holes in the flange and bolt the fire penetration seal to the structure. Minimum 4 positions.

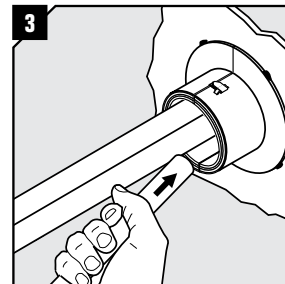

Route the pipes through the aperture and fire penetration seal.

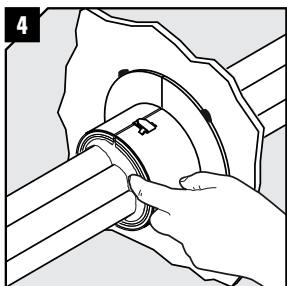

Fill the void between the pipes and the inside of the fire penetration seal with Roxtec smoke seal putty. Smooth the surface of the putty.

Option 1

For smoke-tight applications. Sealant from non fire penetration sealing side.

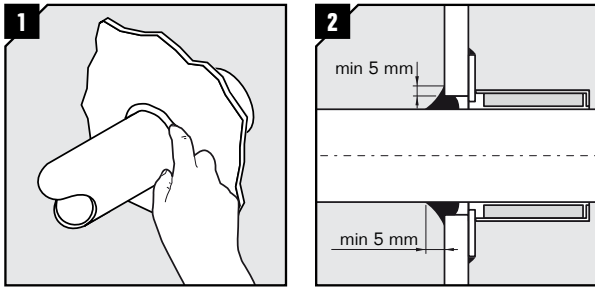

Apply Roxtec sealant into the annular gap between the plastic pipe and the structure.
 Arrange a chamfered filling extending at least 5 mm along the plastic pipe and at least 5 mm onto the structure.

Option 2

For smoke-tight applications. Sealant before installing fire penetration seal.

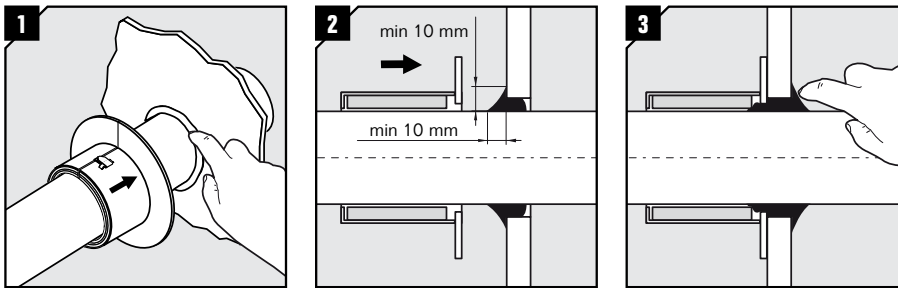

Apply Roxtec sealant into the annular gap between the plastic pipe and the structure.
 Arrange a chamfered filling extending at least 10 mm along the plastic pipe and with an offset at least 10 mm towards/onto the structure.

After finalized installation of the fire penetration seal, the excessive pressed-out Roxtec sealant is smoothed out on the non fire penetration sealing side, filling the annular gap around the plastic pipe and the structure.

Disassembly

Reverse order

Note

- Please see type approval certificates for detailed application information.

DISCLAIMER

"The Roxtec cable entry sealing system ("the Roxtec system") is a modular based system of sealing products consisting of different components. Each and every one of the components is necessary for the best performance of the Roxtec system. The Roxtec system has been certified to resist a number of different hazards. Any such certification, and the ability of the Roxtec system to resist such hazards, is dependent on all components that are installed as a part of the Roxtec system. Thus, the certification is not valid and does not apply unless all components installed as part of the Roxtec system are manufactured by or under license from Roxtec ("authorized manufacturer"). Roxtec gives no performance guarantee with respect to the Roxtec system, unless (I) all components installed as part of the Roxtec system are manufactured by an authorized manufacturer and (II) the purchaser is in compliance with (a), and (b), below.

(a) During storage, the Roxtec system or part thereof, shall be kept indoors in its original packaging at room temperature.

(b) Installation shall be carried out in accordance with Roxtec installation instructions in effect from time to time.

The product information provided by Roxtec does not release the purchaser of the Roxtec system, or part thereof, from the obligation to independently determine the suitability of the products for the intended process, installation and/or use. Roxtec gives no guarantee for the Roxtec system or any part thereof and assumes no liability for any loss or damage whatsoever, whether direct, indirect, consequential, loss of profit or otherwise, occurred or caused by the Roxtec systems or installations containing components not manufactured by an authorized manufacturer and/or occurred or caused by the use of the Roxtec system in a manner or for an application other than for which the Roxtec system was designed or intended.

Roxtec expressly excludes any implied warranties of merchantability and fitness for a particular purpose and all other express or implied representations and warranties provided by statute or common law. User determines suitability of the Roxtec system for intended use and assumes all risk and liability in connection therewith. In no event shall Roxtec be liable for indirect, consequential, punitive, special, exemplary or incidental damages or losses."

INSTALLATION VIDEO



Roxtec Sleeve-it™ Waterproof penetration seal

ALWAYS CHECK OUR LATEST UPDATES

You find the latest versions of our installations instructions on www.roxtec.com. Roxtec can and will not take responsibility for transits that are not installed according to the latest installation instructions.

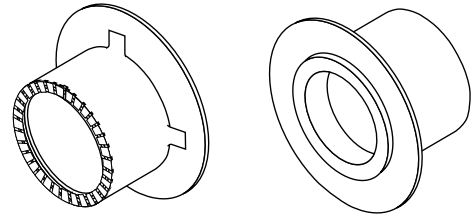

Tools needed



Spray bottle with soapy water

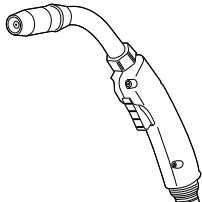

GMAW welder

Installation

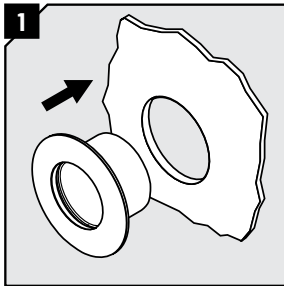

Insert the Roxtec Sleeve-it Waterproof penetration seal into the aperture.

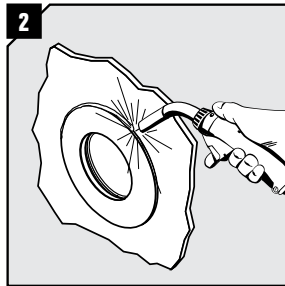

Remove the rubber grommet from the flange. Tight weld the flange to the structure using the GMAW-process.

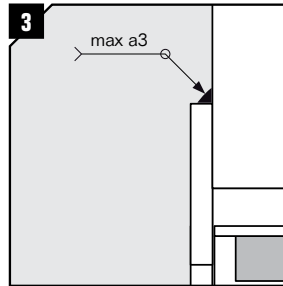

Make a waterproof weld using GMAW to reduce the heat input.

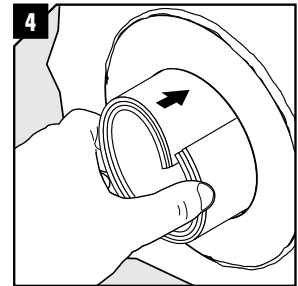

If the intumescent material is supplied separately, insert it after the sleeve has cooled down. Ensure that the intumescent material fits properly into the sleeve.

Routing the pipe, alternative 1

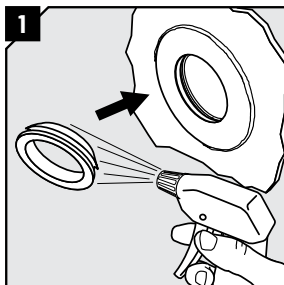

Lubricate the grommet and sleeve with soap water and insert the rubber grommet.

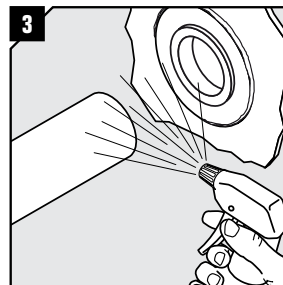
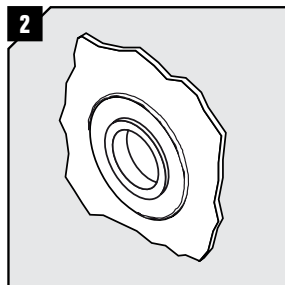

Lubricate the pipe and the rubber grommet thoroughly with soap water.

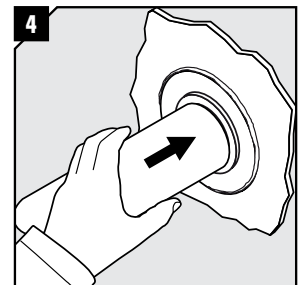

Gently route the pipe through the seal from the grommet side.

Routing the pipe, alternative 2

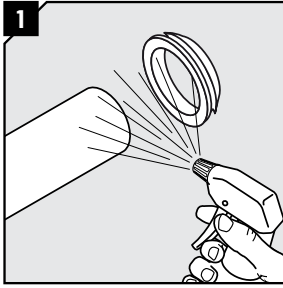

1 Lubricate the pipe and the rubber grommet thoroughly with soap water.

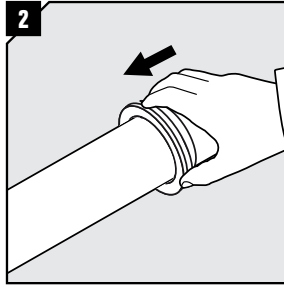

2 Mount the rubber grommet onto the pipe.

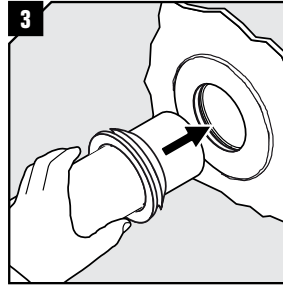

3 Gently route the pipe through the sleeve.

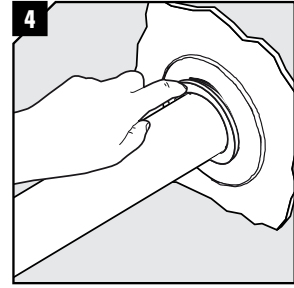

4 Lubricate the grommet with soap water. Insert the grommet into the sleeve.

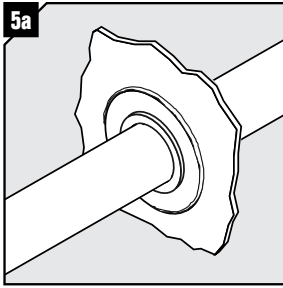

5a Make sure the grommet is properly inserted and secured in the sleeve.

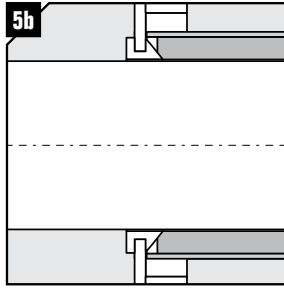

Disassembly

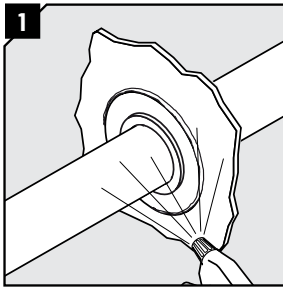

1 Lubricate the pipe and slide of the grommet

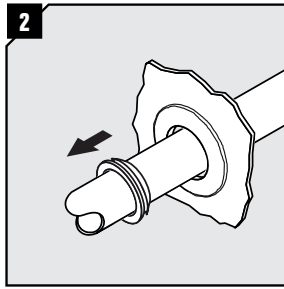

2 Alternatively remove the pipe.

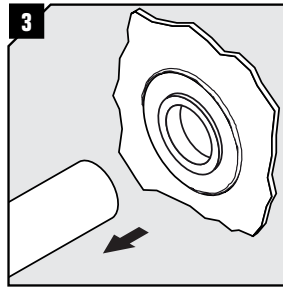

Note

- Please see type approval certificates for detailed application information.

DISCLAIMER

"The Roxtec cable entry sealing system ("the Roxtec system") is a modularbased system of sealing products consisting of different components. Each and every one of the components is necessary for the best performance of the Roxtec system. The Roxtec system has been certified to resist a number of different hazards. Any such certification, and the ability of the Roxtec system to resist such hazards, is dependent on all components that are installed as a part of the Roxtec system. Thus, the certification is not valid and does not apply unless all components installed as part of the Roxtec system are manufactured by or under license from Roxtec ("authorized manufacturer"). Roxtec gives no performance guarantee with respect to the Roxtec system, unless (i) all components installed as part of the Roxtec system are manufactured by an authorized manufacturer and (ii) the purchaser is in compliance with (a), and (b), below.

- (a) During storage, the Roxtec system or part thereof, shall be kept indoors in its original packaging at room temperature.
- (b) Installation shall be carried out in accordance with Roxtec installation instructions in effect from time to time.

The product information provided by Roxtec does not release the purchaser of the Roxtec system, or part thereof, from the obligation to independently determine the suitability of the products for the intended process, installation and/or use. Roxtec gives no guarantee for the Roxtec system or any part thereof and assumes no liability for any loss or damage whatsoever, whether direct, indirect, consequential, loss of profit or otherwise, occurred or caused by the Roxtec systems or installations containing components not manufactured by an authorized manufacturer and/or occurred or caused by the use of the Roxtec system in a manner or for an application other than for which the Roxtec system was designed or intended.

Roxtec expressly excludes any implied warranties of merchantability and fitness for a particular purpose and all other express or implied representations and warranties provided by statute or common law. User determines suitability of the Roxtec system for intended use and assumes all risk and liability in connection therewith. In no event shall Roxtec be liable for indirect, consequential, punitive, special, exemplary or incidental damages or losses.

INSTALLATION VIDEO



Roxtec Sleeve-it™ Transition collar

ALWAYS CHECK OUR LATEST UPDATES

You find the latest versions of our installations instructions on www.roxtec.com. Roxtec can and will not take responsibility for transits that are not installed according to the latest installation instructions.

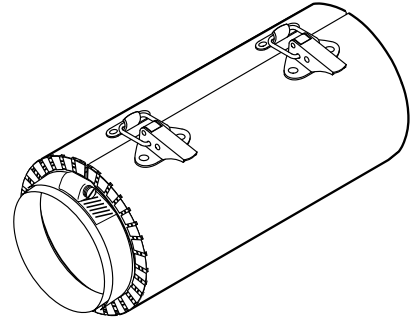

Installation

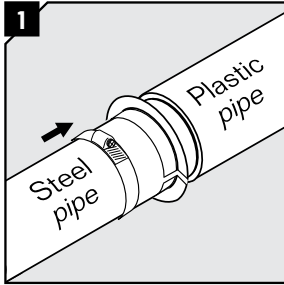

Position hanging bracket on steel pipe close to plastic pipe with clearance accommodating transition collar slot.

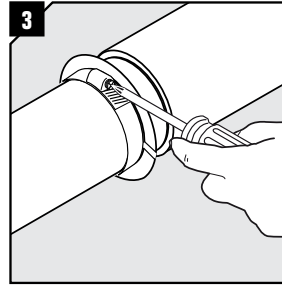
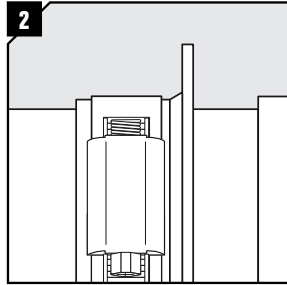

Tighten the jubilee clip to secure the hanging bracket.

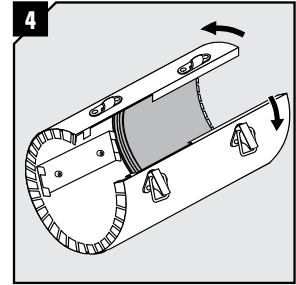

Open the transition collar.

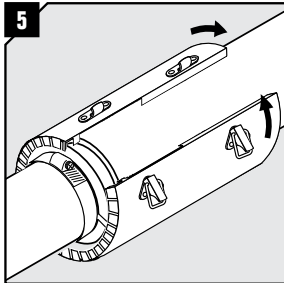

Install the transition collar onto the hanging bracket. Make sure that the intumescent material is on the plastic pipe, not on the steel pipe.

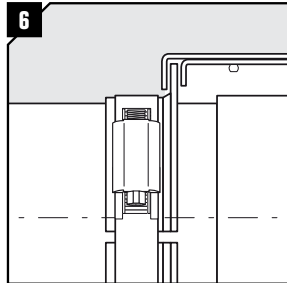

Make sure that the transition between the plastic pipe and the metal pipe is situated as shown in the picture.

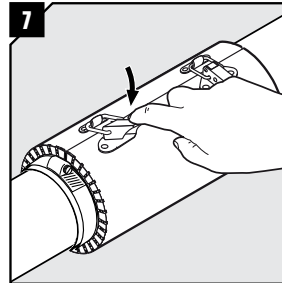

Close the transition collar.

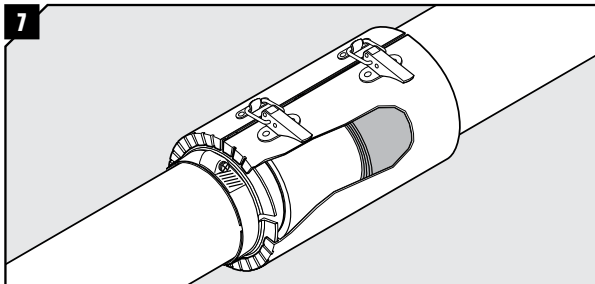

This cross-section view shows the finalized installation.

Disassembly

Reverse order

Note

- Also applicable for bell housing type of plastic pipe joint
- Please see type approval certificates for detailed application information

DISCLAIMER

"The Roxtec cable entry sealing system ("the Roxtec system") is a modularbased system of sealing products consisting of different components. Each and every one of the components is necessary for the best performance of the Roxtec system. The Roxtec system has been certified to resist a number of different hazards. Any such certification, and the ability of the Roxtec system to resist such hazards, is dependent on all components that are installed as a part of the Roxtec system. Thus, the certification is not valid and does not apply unless all components installed as part of the Roxtec system are manufactured by or under license from Roxtec ("authorized manufacturer"). Roxtec gives no performance guarantee with respect to the Roxtec system, unless (I) all components installed as part of the Roxtec system are manufactured by an authorized manufacturer and (II) the purchaser is in compliance with (a), and (b), below.

(a) During storage, the Roxtec system or part thereof, shall be kept indoors in its original packaging at room temperature.

(b) Installation shall be carried out in accordance with Roxtec installation instructions in effect from time to time.

The product information provided by Roxtec does not release the purchaser of the Roxtec system, or part thereof, from the obligation to independently determine the suitability of the products for the intended process, installation and/or use. Roxtec gives no guarantee for the Roxtec system or any part thereof and assumes no liability for any loss or damage whatsoever, whether direct, indirect, consequential, loss of profit or otherwise, occurred or caused by the Roxtec systems or installations containing components not manufactured by an authorized manufacturer and/or occurred or caused by the use of the Roxtec system in a manner or for an application other than for which the Roxtec system was designed or intended.

Roxtec expressly excludes any implied warranties of merchantability and fitness for a particular purpose and all other express or implied representations and warranties provided by statute or common law. User determines suitability of the Roxtec system for intended use and assumes all risk and liability in connection therewith. In no event shall Roxtec be liable for indirect, consequential, punitive, special, exemplary or incidental damages or losses."

INSTALLATION VIDEO



Trainings and inspections

High safety standards require correctly installed and easily inspected products. Installation training for local contractors and post-installation inspections are part of our full line of service.



Product installation training

Whenever you want and wherever you operate, we provide product installation training through our staff. We are there to support and train electrical installers in the field in order to ensure that all installations meet certification requirements. Just call us for more information.

Inspection services

We provide extra safety values by offering onsite inspections. As experts within cable and pipe sealing, we can check the products after the installation, verify the actual installation, and, if necessary, recommend or perform measures. This helps you eliminate any inspection failures.

- Reduce installation time and labor costs
- Ensure quality installation
- Make sure your installers are trained
- Installation instructions available
- Online instruction videos available

Installation checkpoints, rectangular frames

ALWAYS CHECK OUR LATEST UPDATES

You find the latest versions of our installations instructions on www.roxtec.com. Roxtec can and will not take responsibility for transits that are not installed according to the latest installation instructions.

This list of installation checkpoints can be used to visually assess a Roxtec cable/pipe transit sealing system installation. The check is performed to visually verify the correctness of an installation, not a commissioning or functional inspection. The verifications shall be performed and evaluated with the understanding that not all installation errors can be visually detected, even if it is a great help in the quality assurance work. The installation check is limited to those areas and sections of the installation to which reasonable access is both available and permitted at the date of checking. The scope of these installation checkpoints is limited to the transit (frame, modules, stayplates and wedge). Consequently, it does not cover the attachment of the transit to the structure in question, e.g. insulation required, nor the correctness, quality or routing of cables/pipes. If possible perform the installation check from both sides of the transit.

Checkpoints

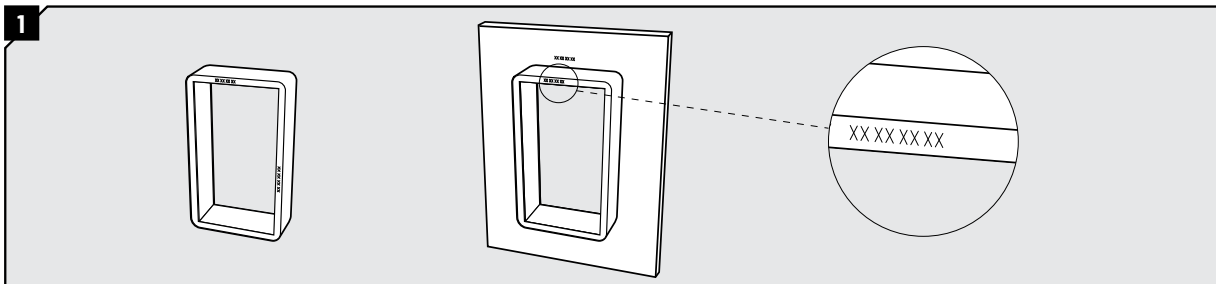

Original Roxtec frame are identified by Roxtec marking or frame serial number marking. Frames have the marking or label on the front face.

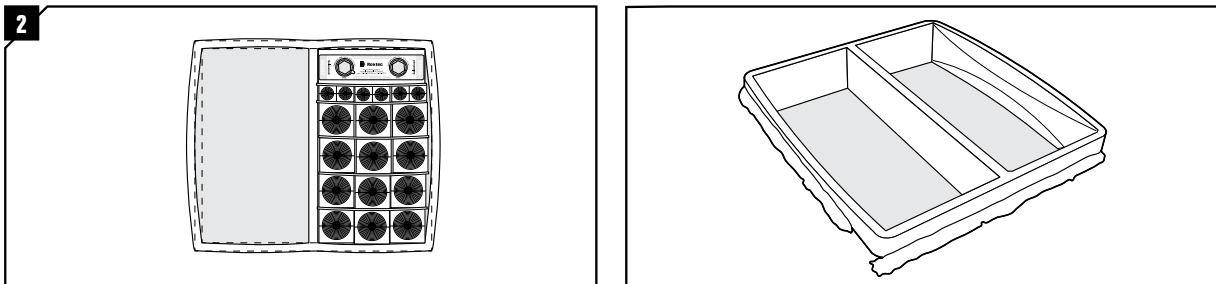

Check that the transit and packing system have no mechanical damages, including surface protection, if any. For welding, see Roxtec welding guidelines.

Packing space

Frame height (H)	Packing height (h)	Frame size
101	60	2
160	120	4
218	180	6
278	240	8

Verify the correct utilization of the entire packing space.

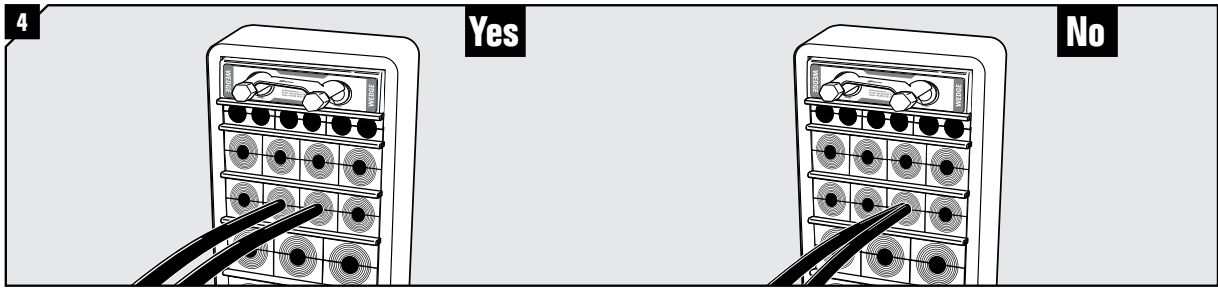

Check that only one cable/pipe passes through each module or opening in a module.

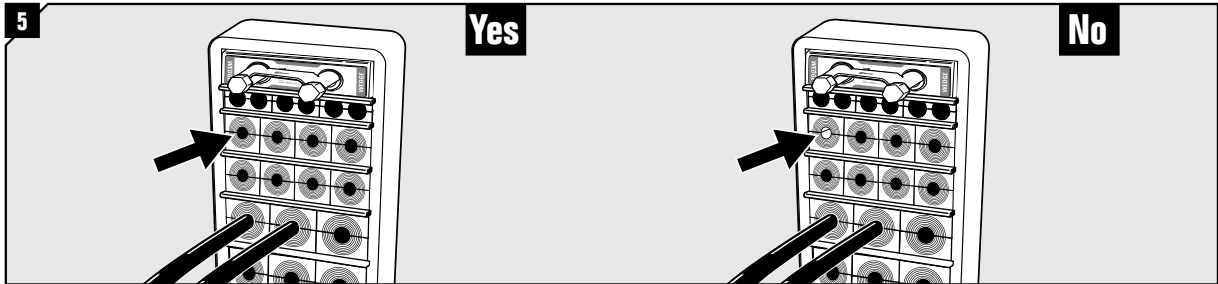

Check that there are no center cores missing.

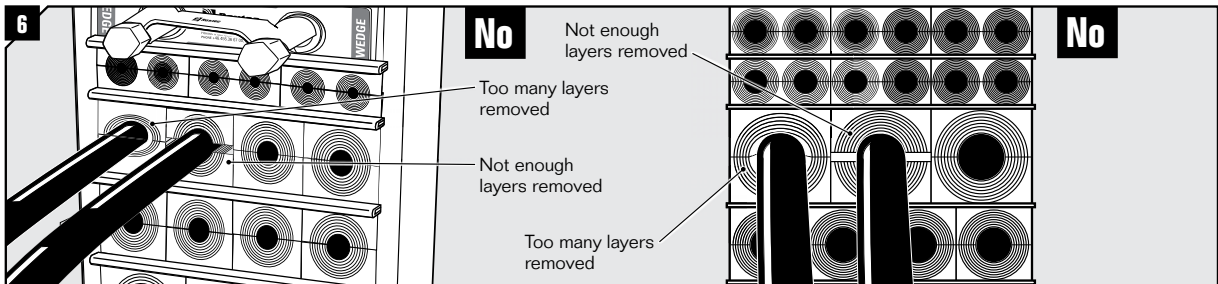

Check that there is no visible gap between cable/pipe and modules after compression. Maximum one layer difference between halves of the same module.

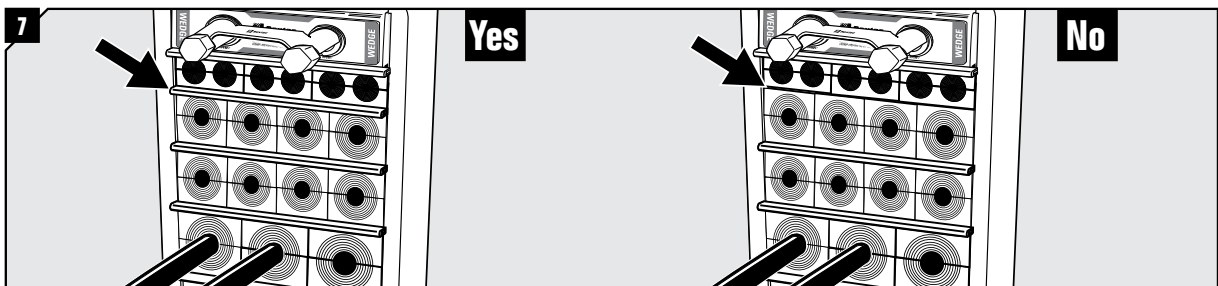

Check that each consecutive row of modules is divided by a stayplate.

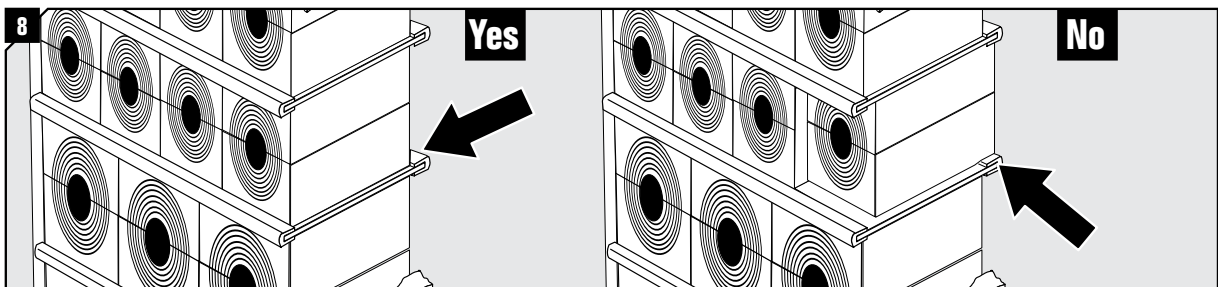

Check that all modules are installed between the edges of the stayplates.

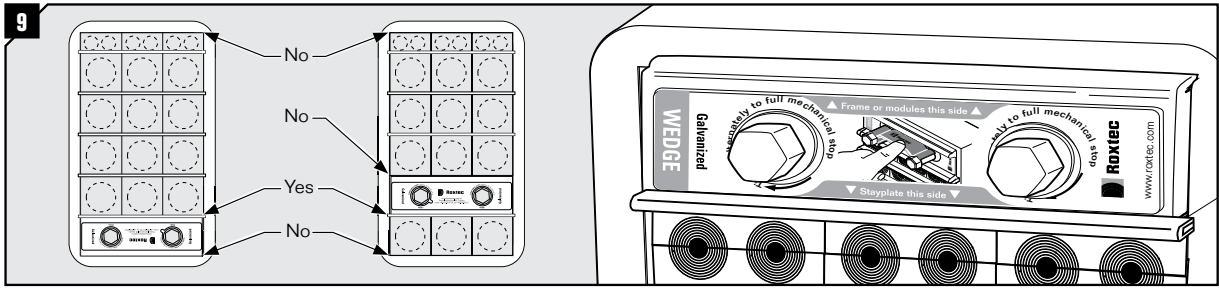

Verify that there is no stayplate installed between modules and the frame or between the wedge and the frame. Verify the correct orientation of the wedge according to the label on the wedge front side or printed text on the upper and lower faces of the unit.

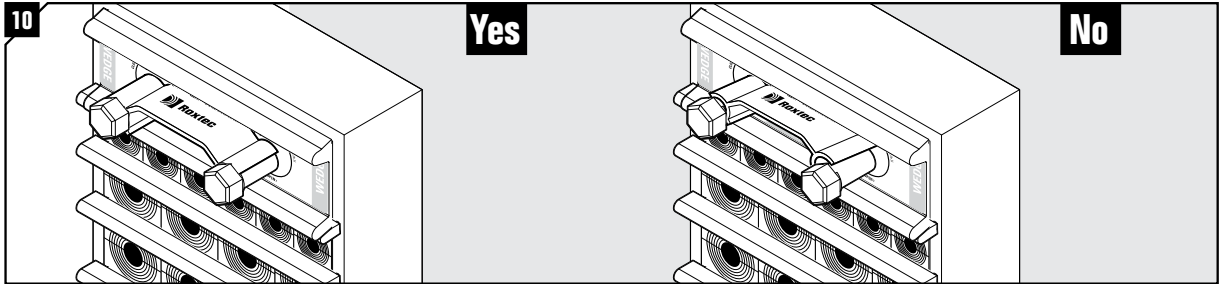

Check that the wedge is fully tightened by verifying that the wedge clip is installed and fits behind the bolt heads.

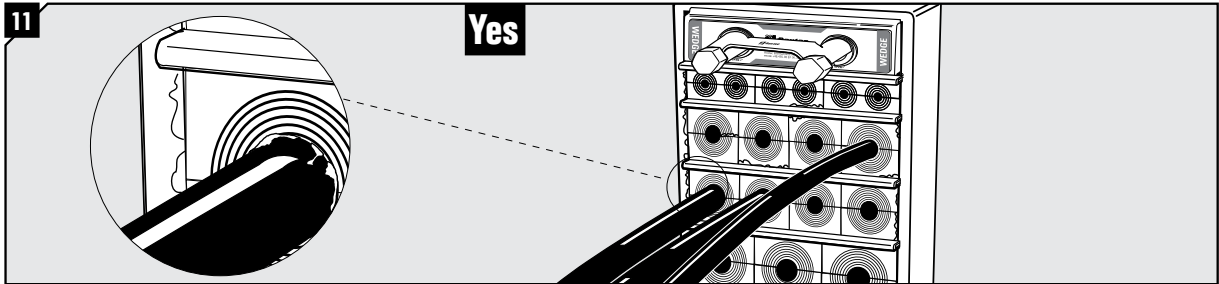

Check that the frame and the modules have been lubricated. Excess lubricant shall be visible directly after installation.

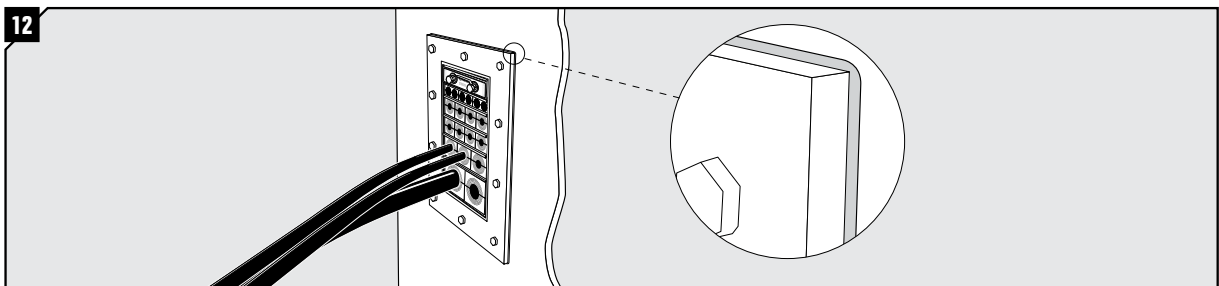

Make sure that bolted frame types are sealed to the structure and that all attachment points are used.

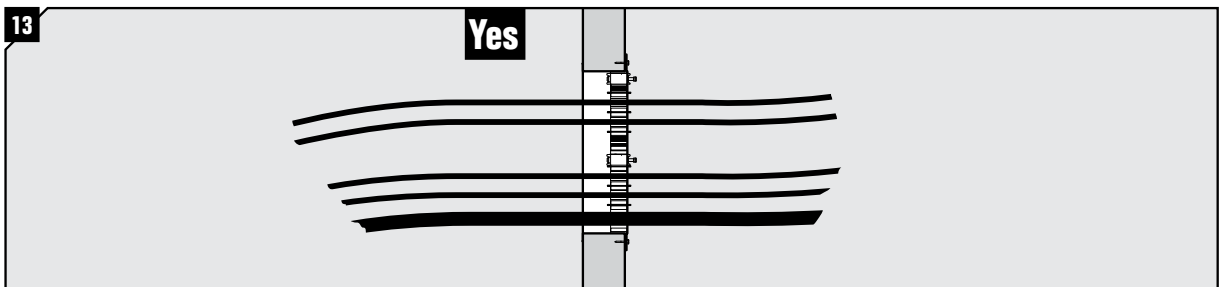

Make sure that cables go straight through the frame.

Note

- If possible, take an overlook at the other side of the transit.
- Check additional installations according to certification requirements, e.g. insulation.

DISCLAIMER

"The Roxtec cable entry sealing system ("the Roxtec system") is a modular-based system of sealing products consisting of different components. Each and every one of the components is necessary for the best performance of the Roxtec system. The Roxtec system has been certified to resist a number of different hazards. Any such certification, and the ability of the Roxtec system to resist such hazards, is dependent on all components that are installed as a part of the Roxtec system. Thus, the certification is not valid and does not apply unless all components installed as part of the Roxtec system are manufactured by or under license from Roxtec ("authorized manufacturer"). Roxtec gives no performance guarantee with respect to the Roxtec system, unless (I) all components installed as part of the Roxtec system are manufactured by an authorized manufacturer and (II) the purchaser is in compliance with (a), and (b), below.

- (a) During storage, the Roxtec system or part thereof, shall be kept indoors in its original packaging at room temperature.
- (b) Installation shall be carried out in accordance with Roxtec installation instructions in effect from time to time.

The product information provided by Roxtec does not release the purchaser of the Roxtec system, or part thereof, from the obligation to independently determine the suitability of the products for the intended process, installation and/or use. Roxtec gives no guarantee for the Roxtec system or any part thereof and assumes no liability for any loss or damage whatsoever, whether direct, indirect, consequential, loss of profit or otherwise, occurred or caused by the Roxtec systems or installations containing components not manufactured by an authorized manufacturer and/or occurred or caused by the use of the Roxtec system in a manner or for an application other than for which the Roxtec system was designed or intended.

Roxtec expressly excludes any implied warranties of merchantability and fitness for a particular purpose and all other express or implied representations and warranties provided by statute or common law. User determines suitability of the Roxtec system for intended use and assumes all risk and liability in connection therewith. In no event shall Roxtec be liable for indirect, consequential, punitive, special, exemplary or incidental damages or losses."

Installation checklist, rectangular frames

ALWAYS CHECK OUR LATEST UPDATES
 You find the latest versions of our installations instructions on www.roxtec.com.
 Roxtec can and will not take responsibility for transits that are not installed according to the latest installation instructions.

For disclaimer and instructions of use, see Installation checkpoints rectangular frames ASS2011004301.

Project/object:

Date:

Transit name:

Full name:

Frame type:

Company:

Opening:

C1	C2	C3	C4	C5	C6	C7	C8	C9	C10
B1	B2	B3	B4	B5	B6	B7	B8	B9	B10
A1	A2	A3	A4	A5	A6	A7	A8	A9	A10

Signature:

Check-point	Activity	OK	Not OK
1	Verify original Roxtec frame by marking.		
2	Check for mechanical damages.		
3	Verify the utilization of the packing space.		
4	Check that only one cable/pipe passes through each module.		
5	Check that there is no center cores missing.		
6	Check that there are no visible gap between cable/pipe and module halves.		
7	Check that each consecutive row is divided by a stayplate.		
8	All modules are within the edges of the stayplates.		
9	Verify that there is no stayplate installed next to the frame.		
10	Check that the wedge is fully tightened.		
11	Make sure the frame and the modules have been lubricated.		
12	Check for gaskets and attachment bolts, if applicable.		
13	Check additional installations, if applicable. Make sure that cables go straight through the frame.		

Notes:

Installation checkpoints, round frames

ALWAYS CHECK OUR LATEST UPDATES

You find the latest versions of our installations instructions on www.roxtec.com. Roxtec can and will not take responsibility for transits that are not installed according to the latest installation instructions.

This list of installation checkpoints can be used to visually assess a Roxtec cable/pipe transit sealing system installation. The check is performed to visually verify the correctness of an installation, not a commissioning or functional inspection. The verifications shall be performed and evaluated with the understanding that not all installation errors can be visually detected, even if it is a great help in the quality assurance work. The installation check is limited to those areas and sections of the installation to which reasonable access is both available and permitted at the date of checking. The scope of these installation checkpoints is limited to the transit (frame, modules, stayplates and wedge). Consequently, it does not cover the attachment of the transit to the structure in question, e.g. insulation required, nor the correctness, quality or routing of cables/pipes. If possible perform the installation check from both sides of the transit.

Checkpoints

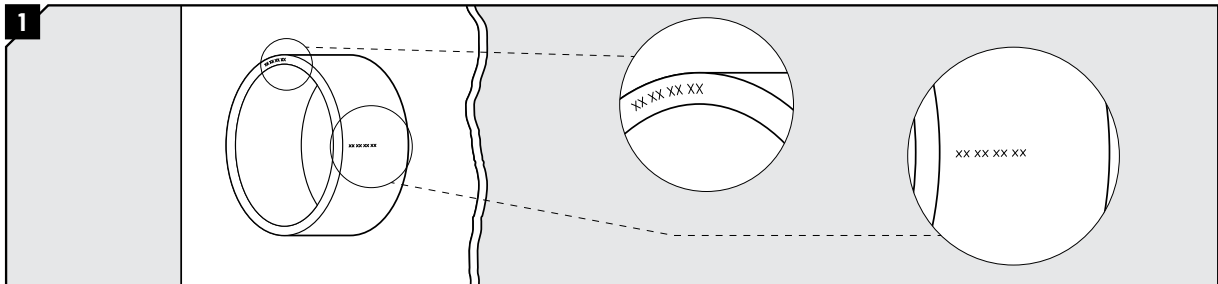

Original Roxtec sleeves are identified by Roxtec marking, serial number marking or label. Sleeves can have marking on the front face or the side.

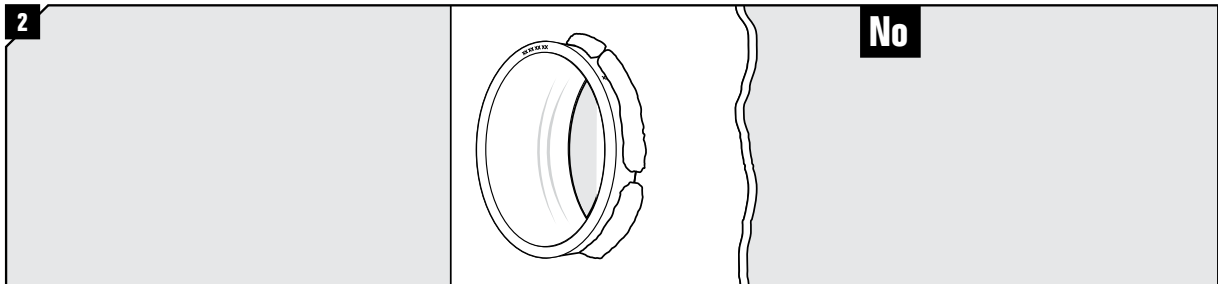

Check that the transit and packing system have no mechanical damages, including surface protection, if any. For welding, see Roxtec welding guidelines.

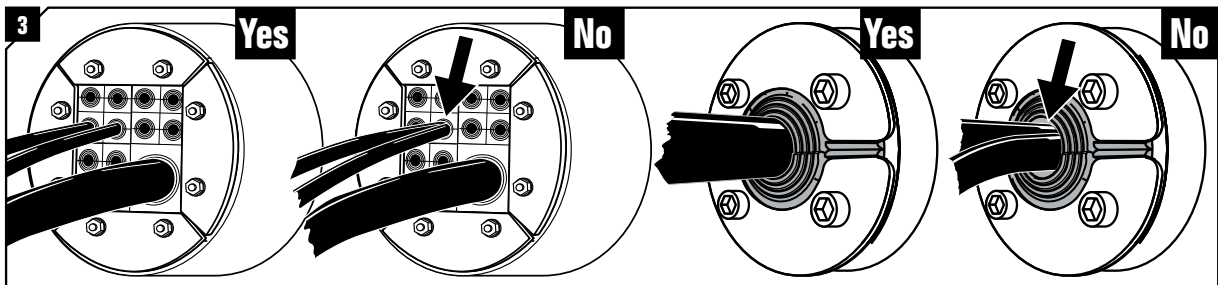

Check that only one cable/pipe passes through each module or opening in a module.

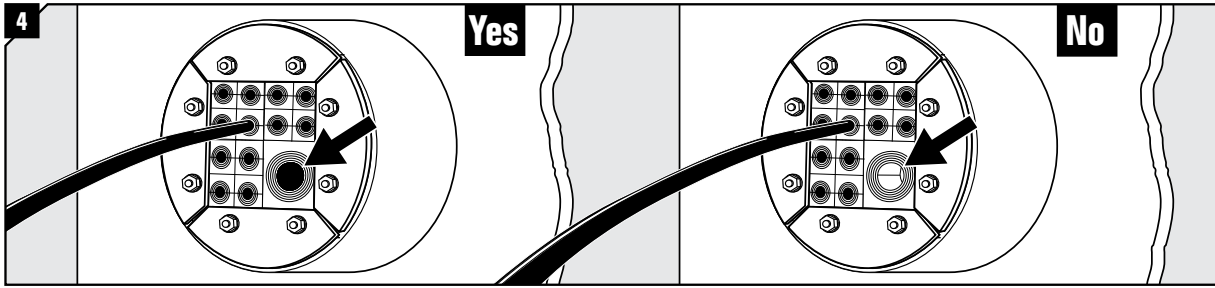

Check that there are no center cores missing.

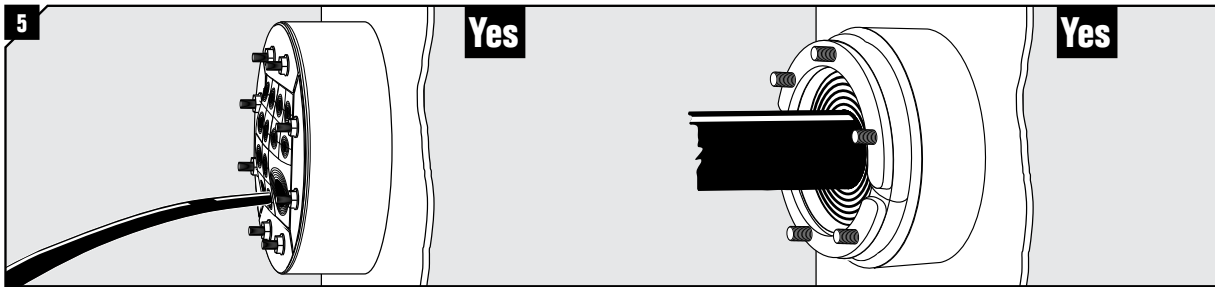

Check that all bolts are tightened similarly.

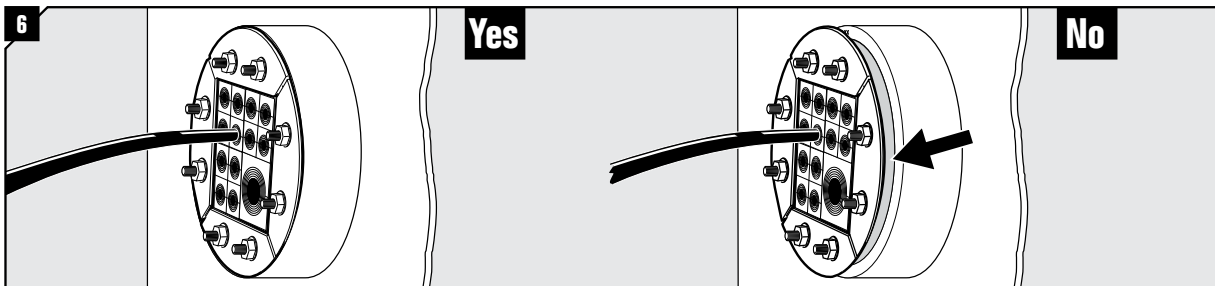

Verify that the frame is pushed in all the way to the sleeve.

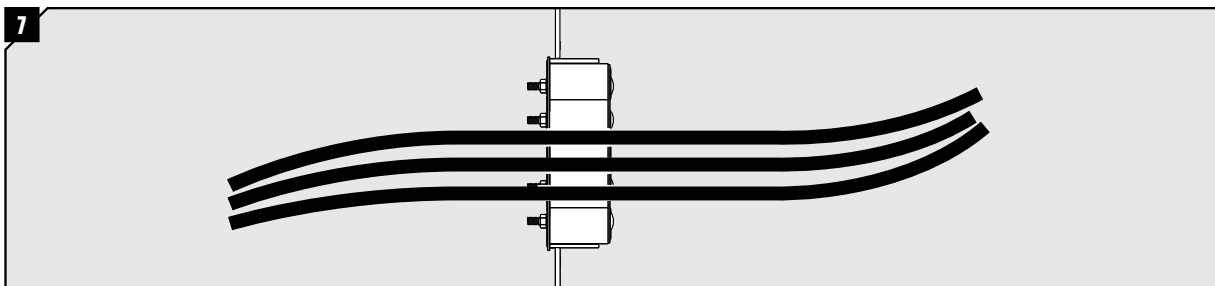

Make sure that cables go straight through the frame.

R Frames

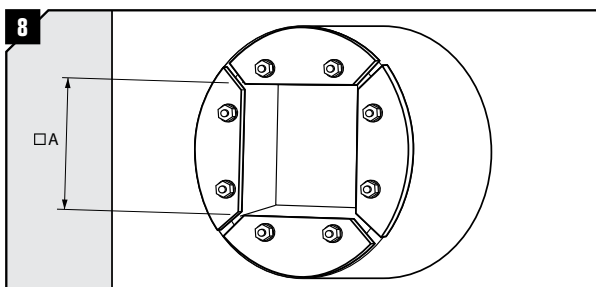

Roxtec R frame packing space

Frame	Packing space
R70/75	□A=40mm
R100	□A=60mm
R125/127	□A=80mm
R150	□A=90mm
R200	□A=120mm

Verify the correct utilization of the entire packing space (R frames).

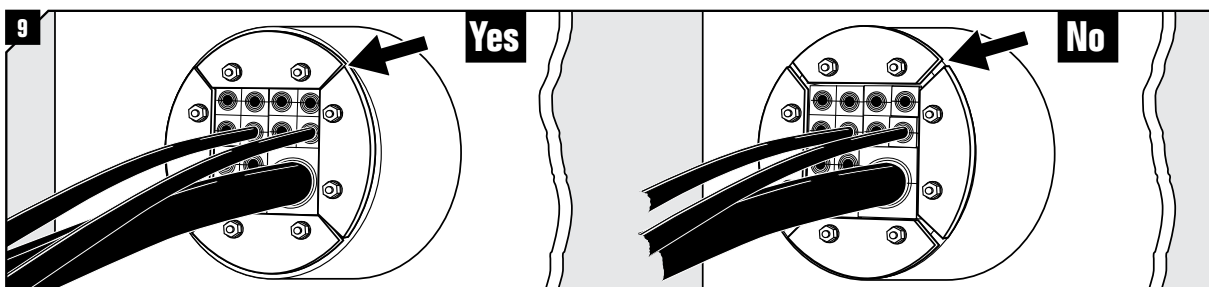

Make sure that the front fittings are positioned so that the modules are retained.

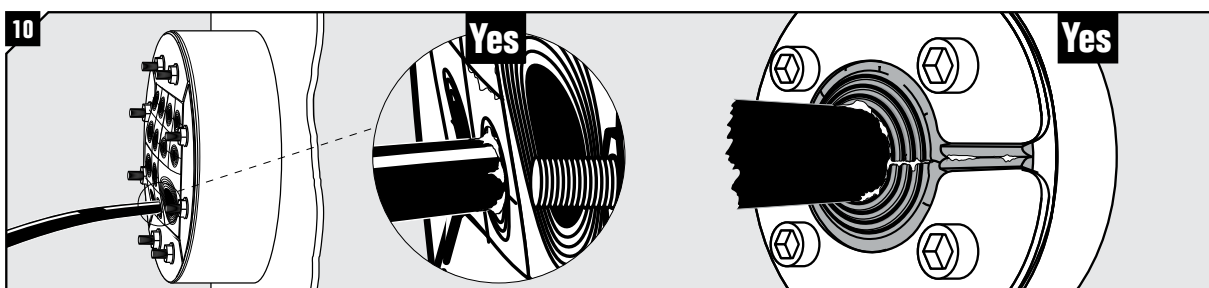

Check the compression by verifying that the bolts are tightened similarly and that excessive lubricant is visible directly after installation.

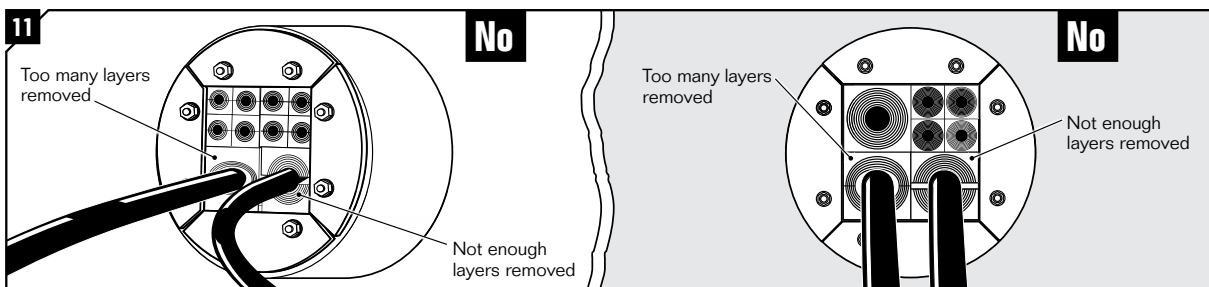

Check that there is no visible gap between cable/pipe and module halves. Maximum one layer difference between halves of the same module. Check that front fitting still holds the modules retained after bolts are tightened.

Note

- If possible, take an overlook at the other side of the transit.
- Check additional installations according to certification requirements, e.g. insulation.

DISCLAIMER

"The Roxtec cable entry sealing system ("the Roxtec system") is a modularbased system of sealing products consisting of different components. Each and every one of the components is necessary for the best performance of the Roxtec system. The Roxtec system has been certified to resist a number of different hazards. Any such certification, and the ability of the Roxtec system to resist such hazards, is dependent on all components that are installed as a part of the Roxtec system. Thus, the certification is not valid and does not apply unless all components installed as part of the Roxtec system are manufactured by or under license from Roxtec ("authorized manufacturer"). Roxtec gives no performance guarantee with respect to the Roxtec system, unless (I) all components installed as part of the Roxtec system are manufactured by an authorized manufacturer and (II) the purchaser is in compliance with (a), and (b), below.

(a) During storage, the Roxtec system or part thereof, shall be kept indoors in its original packaging at room temperature.

(b) Installation shall be carried out in accordance with Roxtec installation instructions in effect from time to time.

The product information provided by Roxtec does not release the purchaser of the Roxtec system, or part thereof, from the obligation to independently determine the suitability of the products for the intended process, installation and/or use. Roxtec gives no guarantee for the Roxtec system or any part thereof and assumes no liability for any loss or damage whatsoever, whether direct, indirect, consequential, loss of profit or otherwise, occurred or caused by the Roxtec systems or installations containing components not manufactured by an authorized manufacturer and/or occurred or caused by the use of the Roxtec system in a manner or for an application other than for which the Roxtec system was designed or intended.

Roxtec expressly excludes any implied warranties of merchantability and fitness for a particular purpose and all other express or implied representations and warranties provided by statute or common law. User determines suitability of the Roxtec system for intended use and assumes all risk and liability in connection therewith. In no event shall Roxtec be liable for indirect, consequential, punitive, special, exemplary or incidental damages or losses."

Installation checklist, round frames

ALWAYS CHECK OUR LATEST UPDATES
 You find the latest versions of our installations instructions on www.roxtec.com.
 Roxtec can and will not take responsibility for transits that are not installed according to the latest installation instructions.

For disclaimer and instructions of use, see Installation checkpoints round frames ASS2011004401.

Project/object:

Date:

Transit name:

Full name:

Frame type:

Company:

Opening:

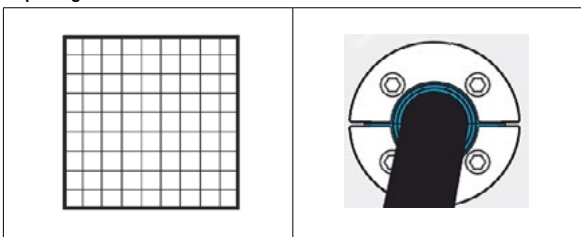

Signature:

Check-point	Activity	OK	Not OK
1	Verify original Roxtec sleeve by marking.		
2	Check for mechanical damages.		
3	Check that only one cable/pipe passes through each module.		
4	Check that there are no center cores missing.		
5	Check that all bolts are tightened similarly.		
6	Verify that the frame is pushed in all the way to the sleeve.		
7	Make sure the cables go straight through the frame.		
8	Verify the correct utilization of the entire packing space.		
9	Make sure the front fittings are positioned.		
10	Check the compression.		
11	Check that there is no visible gap between cable/pipe and modules.		

Notes:

PRACTICAL USER GUIDELINES



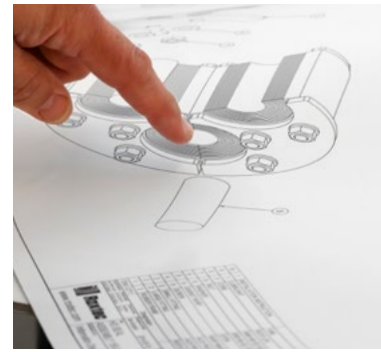

WELDING	266
S frame, aperture dimensions	266
SRC frame, aperture dimensions	267
SF frame, aperture dimensions	268
G frame, aperture dimensions and welding guidelines	271
S, SRC, SK and SBTB frames, welding guidelines	272
Sleeves, welding guidelines	274
BOLTING	276
SF frame, aperture dimensions	276
GHM frame, aperture dimensions	277
SF and GHM frames, bolting guidelines	278
G frame, bolting guidelines	279
KFO/C KFO frame, assembly	280
Sleeves, aperture dimensions	281
Sleeves, bolting guidelines	282
INSULATION	283
TEMPLATES/HOLECUT PATTERNS	284
KFO frame	284
C KFO frame	285
CF 8/CF 32 frames	286
ComSeal LW	287
ComSeal/ ComSeal EMC	289



S frame, aperture dimensions for welded installations

Frame	Height tolerance ± 1 mm, ±0.039"				Width tolerance ± 1 mm ± 0.039"									
	1 opening in width (mm) (in)		>1 opening in width (mm) (in)		x1	x2	x3	x4	x5	x6	x7	x8	x9	x10
S 1	123	4.843			82 3.228									
S 2	123	4.843	123	4.409										
S 2+2	234	9.213	244	9.606	143 5.630	273 10.748	404 15.906	534 21.024	665 26.181	795 31.299	926 36.457	1056 41.575	1187 46.732	1317 51.850
S 2+2+2	345	13.583	365	14.370										
S 3	182	7.165			82 3.228									
S 4	182	7.165	182	7.165										
S 4+4	351	13.819	361	14.213	143 5.630	273 10.748	404 15.906	534 21.024	665 26.181	795 31.299	926 36.457	1056 41.575	1187 46.732	1317 51.850
S 4+4+4	521	20.512	541	21.299										
S 5	240	9.449			82 3.228									
S 6	240	9.449	240	9.449										
S 6+6	468	18.425	478	18.819	143 5.630	273 10.748	404 15.906	534 21.024	665 26.181	795 31.299	926 36.457	1056 41.575	1187 46.732	1317 51.850
S 6+6+6	696	27.402	716	28.189										
S 8	300	11.811	300	11.811										
S 8+8	588	23.150	598	23.543	143 5.630	273 10.748	404 15.906	534 21.024	665 26.181	795 31.299	926 36.457	1056 41.575	1187 46.732	1317 51.850
S 8+8+8	876	34.488	896	35.276										

Theoretically recommended dimensions



SRC frame, aperture dimensions for welded installations

Frame	Height tolerance ± 1 mm, ±0.039"				Width tolerance ± 1 mm ± 0.039"										Radius ± 1 mm ± 0.039"
	1 opening in width (mm) (in)		>1 opening in width (mm) (in)		x1	x2	x3	x4	x5	x6	x7	x8	x9	x10	
SRC r20															
2	123	4.843	123	4.843											
2+2	234	9.213	244	9.606	143	273	404	534	665	795	926	1056	1187	1317	31
2+2+2	345	13.583	365	14.370	5.630	10.748	15.906	21.024	26.181	31.299	36.457	41.575	46.732	51.850	1.220
4	182	7.165	182	7.165											
4+4	351	13.819	361	14.213	143	273	404	534	665	795	926	1056	1187	1317	31
4+4+4	521	20.512	541	21.299	5.630	10.748	15.906	21.024	26.181	31.299	36.457	41.575	46.732	51.850	1.220
6	240	9.449	240	9.449											
6+6	468	18.425	478	18.819	143	273	404	534	665	795	926	1056	1187	1317	31
6+6+6	696	27.402	716	28.189	5.630	10.748	15.906	21.024	26.181	31.299	36.457	41.575	46.732	51.850	1.220
8	300	11.811	300	11.811											
8+8	588	23.150	598	23.543	143	273	404	534	665	795	926	1056	1187	1317	31
8+8+8	876	34.488	896	35.276	5.630	10.748	15.906	21.024	26.181	31.299	36.457	41.575	46.732	51.850	1.220
SRC r40															
4	182	7.165	182	7.165											
4+4	351	13.819	361	14.213	143	273	404	534	665	795	926	1056	1187	1317	51
4+4+4	521	20.512	541	21.299	5.630	10.748	15.906	21.024	26.181	31.299	36.457	41.575	46.732	51.850	2.008
6	240	9.449	240	9.449											
6+6	468	18.425	478	18.819	143	273	404	534	665	795	926	1056	1187	1317	51
6+6+6	696	27.402	716	28.189	5.630	10.748	15.906	21.024	26.181	31.299	36.457	41.575	46.732	51.850	2.008
8	300	11.811	300	11.811											
8+8	588	23.150	598	23.543	143	273	404	534	665	795	926	1056	1187	1317	51
8+8+8	876	34.488	896	35.276	5.630	10.748	15.906	21.024	26.181	31.299	36.457	41.575	46.732	51.850	2.008

Theoretically recommended dimensions

R 31 mm (R 1.220")

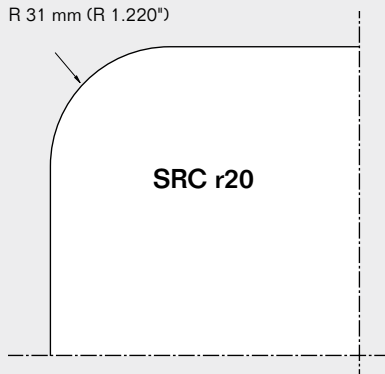

R 51 mm (R 2.008")

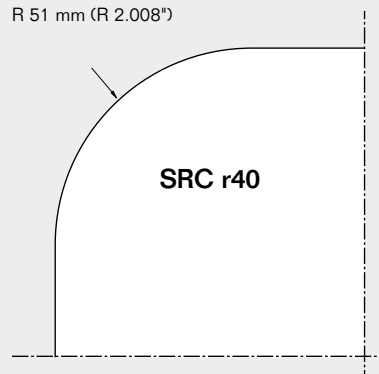



SF frame, aperture dimensions for welded installations

Frame	Height tolerance ± 15 mm, ±0.591"				Width tolerance ± 15 mm ± 0.591"									
	1 opening in width		>1 opening in width		x1	x2	x3	x4	x5	x6	x7	x8	x9	x10
	(mm)	(in)	(mm)	(in)										
SF 2	181	7.126	181	7.126										
SF 2+2	292	11.496	302	11.890	201 7.913	332 13.071	462 18.189	593 23.346	723 28.465	854 33.622	984 38.740	1115 43.898	1245 49.016	1376 54.173
SF 2+2+2	403	15.866	423	16.654										
SF 4	240	9.449	240	9.449										
SF 4+4	409	16.102	419	16.496	201 7.913	332 13.071	462 18.189	593 23.346	723 28.465	854 33.622	984 38.740	1115 43.898	1245 49.016	1376 54.173
SF 4+4+4	579	22.795	599	23.583										
SF 6	298	11.732	298	11.732										
SF 6+6	526	20.709	536	21.102	201 7.913	332 13.071	462 18.189	593 23.346	723 28.465	854 33.622	984 38.740	1115 43.898	1245 49.016	1376 54.173
SF 6+6+6	755	29.724	775	30.512										
SF 8	358	14.094	358	14.094										
SF 8+8	646	25.433	656	25.827	201 7.913	332 13.071	462 18.189	593 23.346	723 28.465	854 33.622	984 38.740	1115 43.898	1245 49.016	1376 54.173
SF 8+8+8	935	36.811	955	37.598										

Theoretically recommended dimensions

SF frame, welding guidelines

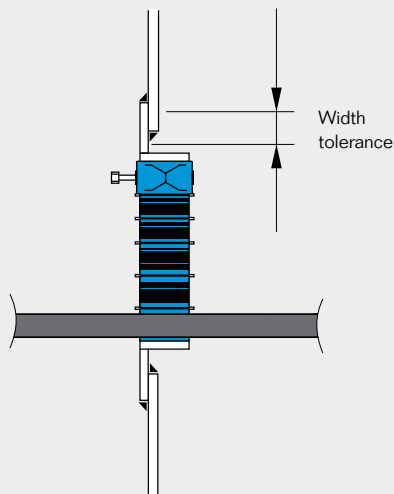

Aperture dimensions are centered on the flange. In corrosive environments care should be taken to reduce the risk of crevice corrosion between the overlapping sheet metal parts. To reduce this risk we recommend butt welded frame installations in structures in these environments.

Information for the welding responsible

This guideline is a help for the welding responsible to produce their own welding procedure specification (WPS).

All welds shall be gas-tight, 4 bar Helium.

Welders qualified acc. to:
 AWS d1.1 latest edition
 EN 287-1 / ISO 9606-1 2013
 ISO 9606-2:2004
 or other authorized system

Welding method:
 Shielded metal arc welding (SMAW)
 Flux core arc welding (FCAW)
 Gas tungsten arc welding (GTAW)

Welding consumables:
 To be chosen according to the materials that shall be welded together. Shall be handled and treated acc. to instructions from manufacturer of consumables.

Mild steel and stainless steel:
 Welding acc. to EN-ISO 5817 min class C

Aluminum:
 Welding acc. to EN-ISO 10042 min class C



SF frame, welding guidelines

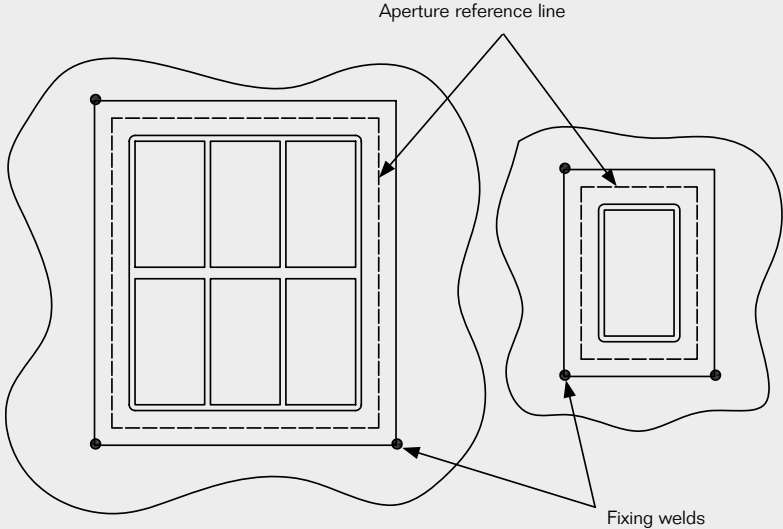

1. Fixing and buttering

The frame can be centered or fixed in a corner of the aperture at any depth.

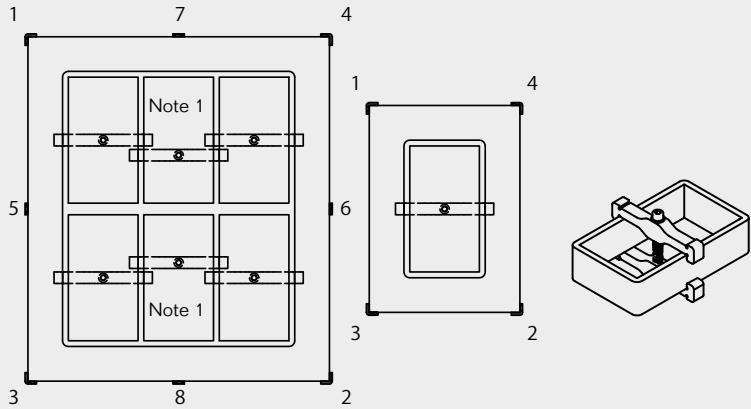
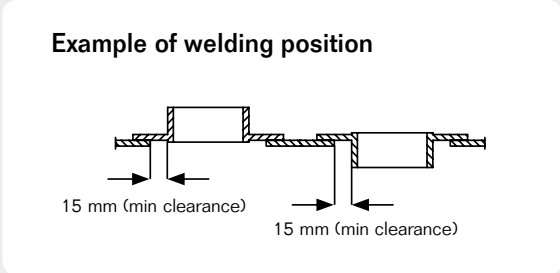

2. Tack weld

Keep the frame in tolerance using a clamp during the whole tacking and welding process. Do not remove the clamp until the frame has a temperature below 50°C.

Apply a tack weld in the corners. Also apply a tack weld as close to the center of every flange as possible in combination frames. Adjust the amount of tack welds depending on frame size.

Note 1
Clamps are required at all side openings and in the middle of a x3 combination frame.

According to drawing S1001155, rev H.
For latest version please visit roxtec.com



SF frame, welding guidelines

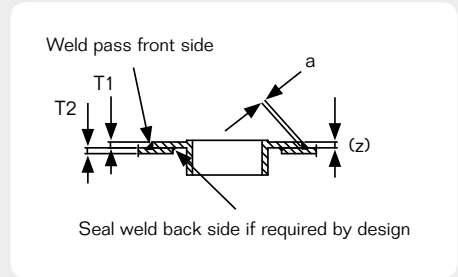
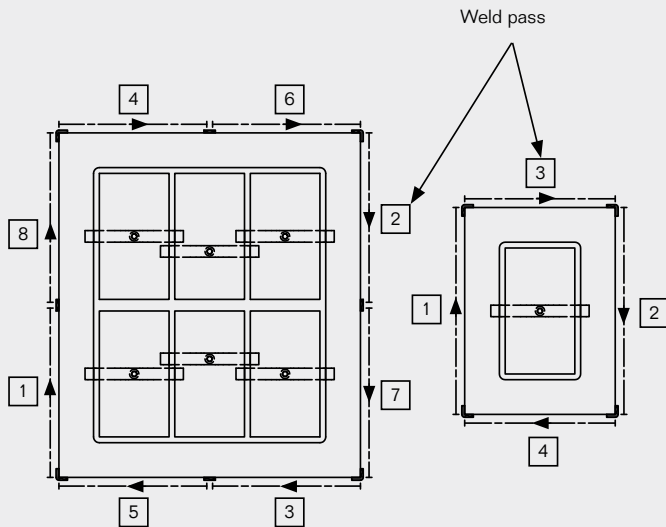

Heat input (kJ/mm) = $\frac{\text{Voltage (U)} \times \text{current (A)} \times 60}{\text{Welding speed (mm/min)} \times 1000 \times \text{efficiency}}$

Efficiency
 SMAW=1.0
 GMAW/FCAW=0.8
 GTAW=0.6

3. Fillet weld

Start by welding the seal weld on the back-side. Grind off the tack welds on the front side before applying the fillet weld.

The interpass temperature shall not exceed 150°C for stainless steel and 250°C for mild steel or aluminum.

Weld run should not exceed 300mm/weld pass.

Note: the seal weld is for corrosion protection and not mandatory.

Weld sizes				Max heat input (kJ/mm)		
T1 (Frame)	T2 (Deck or bulkhead)	Fillet weld size (max)	Seal weld size (max)	Mild steel	Stainless steel	Aluminium
10	<=6	a4 (z5)	a3 (z4)	1,3	1,1	2,5
10	>6	a5 (z7)	a3 (z4)	1,5	1,1	2,5

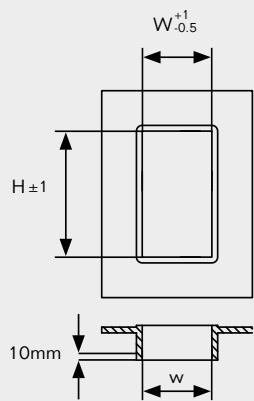

Tolerances after welding		
Size	H	W
1	101	60
2	101	120
3	159,5	60
4	159,5	120
5	218	60
6	218	120
7	278	60
8	278	120

4. Measurement

Measure 10 mm into the frame depth on both sides in accordance with the table. Measurements can be made at frame temperatures below 50°C.

According to drawing S1001155, rev H.
 For latest version please visit roxtec.com



G frame, aperture dimensions for welded installations

Frame	Height tolerance ± 15 mm, ±0.591"		Width tolerance ± 15 mm ± 0.591"									
	(mm)	(in)	x1	x2	x3	x4	x5	x6	x7	x8	x9	x10
G 2	173	6.811										
G 2+2	284	11.181	188 7.402	318 12.520	449 17.677	579 22.795	710 27.953	840 33.071	971 38.228	1101 43.346	1232 48.504	1362 53.622
G 2+2+2	395	15.551										
G 4	232	9.134										
G 4+4	401	15.787	188 7.402	318 12.520	449 17.677	579 22.795	710 27.953	840 33.071	971 38.228	1101 43.346	1232 48.504	1362 53.622
G 4+4+4	571	22.480										
G 6	290	11.417										
G 6+6	518	20.394	188 7.402	318 12.520	449 17.677	579 22.795	710 27.953	840 33.071	971 38.228	1101 43.346	1232 48.504	1362 53.622
G 6+6+6	746	29.370										
G 8	350	13.780										
G 8+8	638	25.118	188 7.402	318 12.520	449 17.677	579 22.795	710 27.953	840 33.071	971 38.228	1101 43.346	1232 48.504	1362 53.622
G 8+8+8	926	36.457										

G frame, welding guidelines

Aperture dimensions are centered on the flange. In corrosive environments care should be taken to reduce the risk of crevice corrosion between the overlapping sheet metal parts. To reduce this risk we recommend butt welded frame installations in structures in these environments.

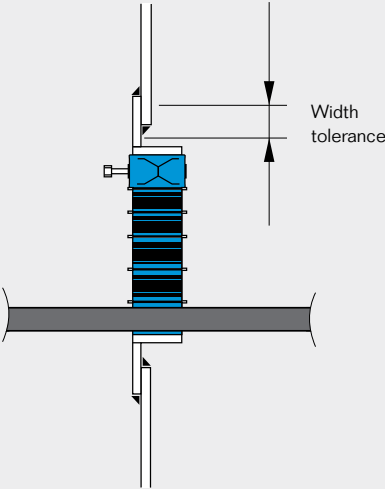

S, SRC, SK, SBTB frames, welding guidelines

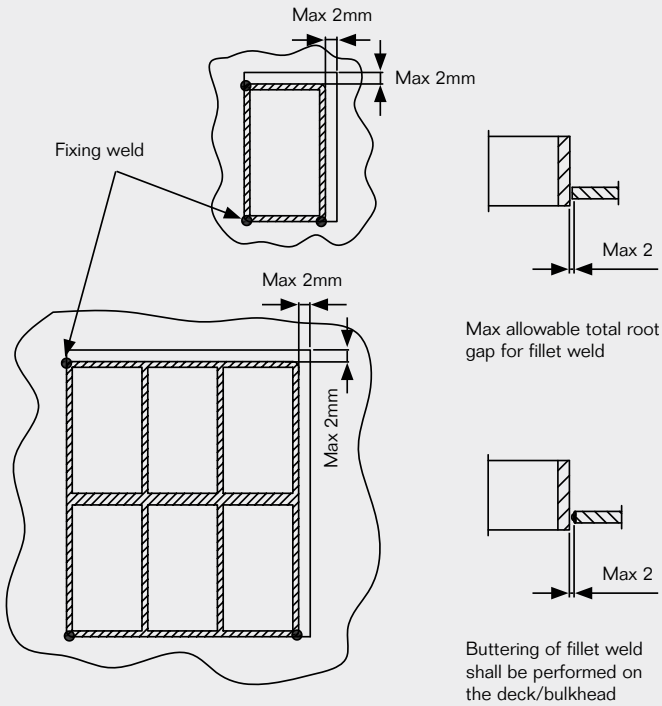

1. Fixing and buttering

The frame can be centered or fixed in a corner of the aperture at any depth.

The maximum allowed total root gap is 2 mm to prevent heat deflection.

Example of positioning

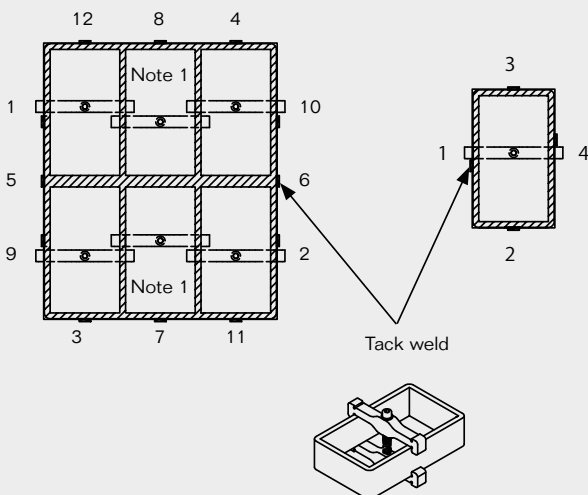
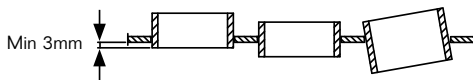

2. Tack weld

Keep the frame in tolerance using a clamp during the whole tacking and welding process. Do not remove the clamp until the frame has a temperature below 50°C.

Apply a tack weld as close to the center of every opening as possible.

Note 1

Clamps are required at all side openings and in the middle of a x3 combination frame.

According to drawing S1000703, rev P.
For latest version please visit roxtec.com

S, SRC, SK, SBTB frames, welding guidelines

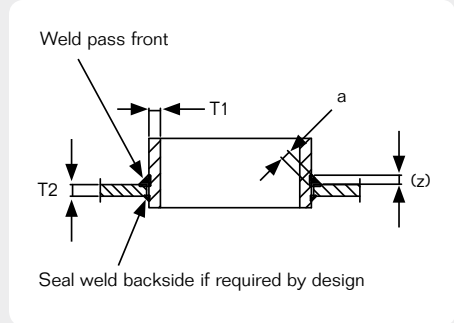
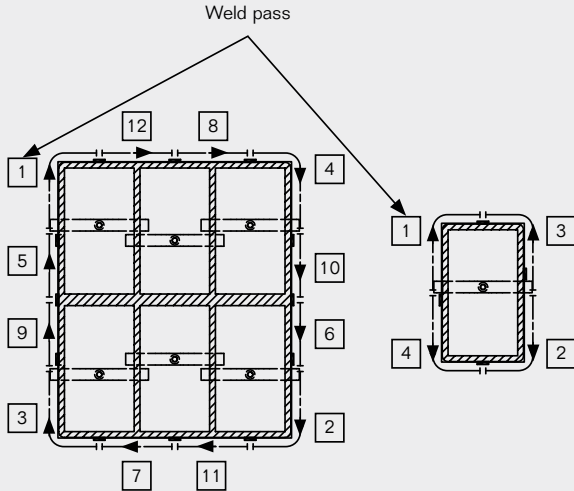

$$\text{Heat input (kJ/mm)} = \frac{\text{Voltage (U)} \times \text{Current (A)} \times 60}{\text{Welding speed (mm/min)} \times 1000 \times \text{Efficiency}}$$

Efficiency
 SMAW=1.0
 GMAW/FCAW=0.8
 GTAW=0.6

3. Fillet weld

Start by welding the seal weld on the backside. Grind off the tack welds on the front side before applying the fillet weld.

The interpass temperature shall not exceed 150°C for stainless steel and 250°C for mild steel or aluminum.

Weld run should not exceed 200 mm/weld pass for mild steel and aluminum and 150 mm for stainless steel.

Note: the seal weld is for corrosion protection and not mandatory.

Weld sizes				Max heat input (kJ/mm)		
T1 (Frame)	T2 (Deck or bulkhead)	Fillet weld size (max)	Seal weld size (max)	Mild steel	Stainless steel	Aluminum
10	<=6	a4 (z5)	a3 (z4)	1,3	1,1	2,5
10	>6	a5 (z7)	a3 (z4)	1,5	1,1	2,5

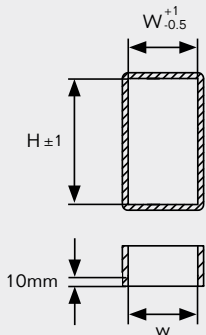

Tolerances after welding

Size	H	W
1	101	60
2	101	120
3	159,5	60
4	159,5	120
5	218	60
6	218	120
7	278	60
8	278	120

4. Measurement

Measure 10 mm into the frame depth in accordance with the table on both sides. Measurements are to be made at frame temperatures below 50°C.

According to drawing S1000703, rev P.
 For latest version please visit roxtec.com



Sleeves, welding guidelines

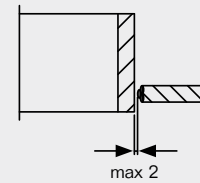
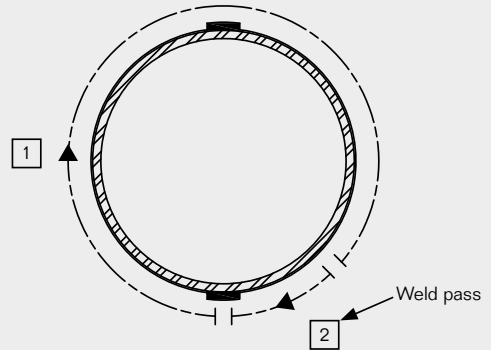
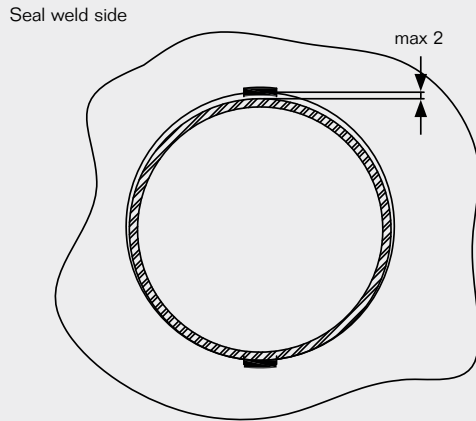
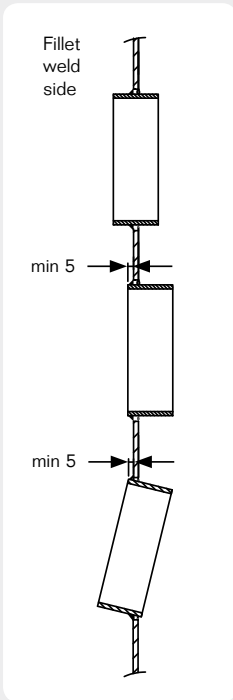

Buttering of fillet weld shall be performed on the deck/bulkhead

$$\text{Heat input (kJ/mm)} = \frac{\text{Voltage (U)} \times \text{Current (A)} \times 60}{\text{Welding speed (mm/min)} \times 1000 \times \text{Efficiency}}$$

Efficiency
 SMAW=1.0
 GMAW/FCAW=0,8
 GTAW=0.6

Weld sizes			Max heat input (kJ/mm)		
Sleeve size	Fillet weld size (max)	Seal weld size (max)	Mild steel	Stainless steel	Aluminum
23-644	a4 (z5)	a3 (z4)	1,3	1,1	2,5

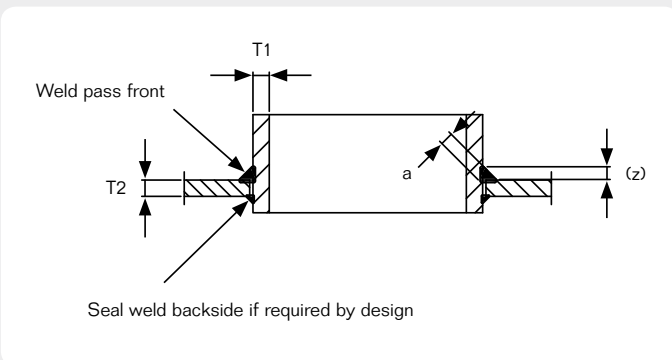

1. Tacking and buttering

The sleeve can be centered or fixed at one side of the aperture at any depth.

The maximum allowed total root gap is 2 mm to prevent heat deflection. Buttering of fillet weld shall be performed on the deck/bulkhead.

2. Fillet weld

Start by welding the seal weld on the backside. Grind off the tack welds on the front side before applying the fillet weld.

The interpass temperature shall not exceed 150°C for stainless steel and 250°C for mild steel or aluminum.

Weld run should not exceed 300 mm/weld pass.

Note: the seal weld is for corrosion protection and not mandatory.

According to drawing S1005870, rev I.
 For latest version please visit roxtec.com



Sleeves, welding guidelines

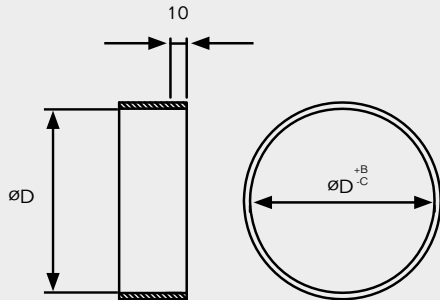

3. Measurement

Measure 10 mm into the sleeve depth on both sides in accordance with the table.

Sleeve dimensions

SLR / SLRS	D (mm)	B (mm)	C (mm)
23	23	1	0
25	25	1	0
31	31	2	0
43	43	2	0
50	50	2	0
68	68	2	0
70	70	2	0
75	75	2	0
100	100	2	0
125	125	2	0
150	150	2	0
175	175	2	0
200	200	3	0
225	225	3	0
250	250	3	0
300	300	3	0
350	350	3	0
400	400	3	0
450	450	3	0
500	500	3	0
550	550	3	0
600	600	3	0
644	644	3	0

According to drawing S1005870, rev I.
For latest version please visit roxtec.com



SF frame, aperture dimensions for bolted installations

Frame	Height tolerance ± 5 mm, ±0.197"				Width tolerance ± 5 mm 0.197"									
	1 opening in width (mm) (in)		>1 opening in width (mm) (in)		x1	x2	x3	x4	x5	x6	x7	x8	x9	x10
SF 2	141	5.551	141	5.551										
SF 2+2	252	9.921	262	10.315	161 6.339	291 11.457	422 16.614	552 21.732	683 26.890	813 32.008	944 37.165	1074 42.283	1205 47.441	1335 52.559
SF 2+2+2	363	14.291	383	15.079										
SF 4	200	7.874	200	7.874										
SF 4+4	369	14.528	379	14.921	161 6.339	291 11.457	422 16.614	552 21.732	683 26.890	813 32.008	944 37.165	1074 42.283	1205 47.441	1335 52.559
SF 4+4+4	539	21.220	559	22.008										
SF 6	258	10.157	258	10.157										
SF 6+6	486	19.134	496	19.528	161 6.339	291 11.457	422 16.614	552 21.732	683 26.890	813 32.008	944 37.165	1074 42.283	1205 47.441	1335 52.559
SF 6+6+6	714	28.110	734	28.898										
SF 8	318	12.520	318	12.520										
SF 8+8	606	23.858	616	24.252	161 6.339	291 11.457	422 16.614	552 21.732	683 26.890	813 32.008	944 37.165	1074 42.283	1205 47.441	1335 52.559
SF 8+8+8	894	35.197	914	35.984										

Theoretically recommended dimensions

For marine applications, special rules may apply for bolted installations. Please check with the classification society.

GHM frame, aperture dimensions for bolted installations



Frame	Height tolerance ± 5 mm, ±0.197"		Width tolerance ± 5 mm ± 0.197"									
	(mm)	(in)	x1	x2	x3	x4	x5	x6	x7	x8	x9	x10
GHM 2	128	5.039										
GHM 2+2	241	9.488	148 5.827	278 10.945	409 16.102	539 21.220	670 26.378	800 31.496	931 36.654	1061 41.772	1192 46.929	1322 52.047
GHM 2+2+2	350	13.780										
GHM 4	187	7.362										
GHM 4+4	358	14.094	148 5.827	278 10.945	409 16.102	539 21.220	670 26.378	800 31.496	931 36.654	1061 41.772	1192 46.929	1322 52.047
GHM 4+4+4	530	20.866										
GHM 6	245	9.646										
GHM 6+6	473	18.622	148 5.827	278 10.945	409 16.102	539 21.220	670 26.378	800 31.496	931 36.654	1061 41.772	1192 46.929	1322 52.047
GHM 6+6+6	705	27.756										

Theoretically recommended dimensions

For marine applications, special rules may apply for bolted applications. Please check with the classification society.

SF and GHM frame, bolting guidelines

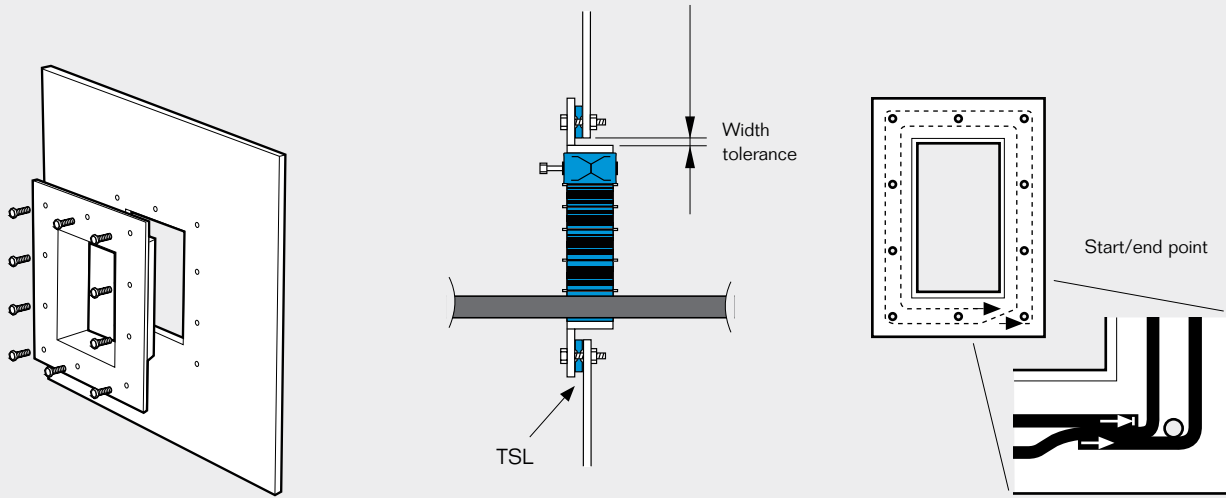

The frame should be fixed to the wall with screws. The screws should be tightened to a torque corresponding to the type and quality grade of the chosen screw. For fast and easy installations, self-tapping drilling screws can be used. Remember to secure that the screws are sealed, to avoid leakage through the thread.

For installations exposed to pressure, a seal must be fitted between the frame and the construction. We recommend the use of our TSL 15x6 sealing strip. Other seals such as a compound is another alternative.

When using TSL 15x6, the sealing strip should be applied on the flange side facing the bulkhead or deck.

G frame, bolting guidelines

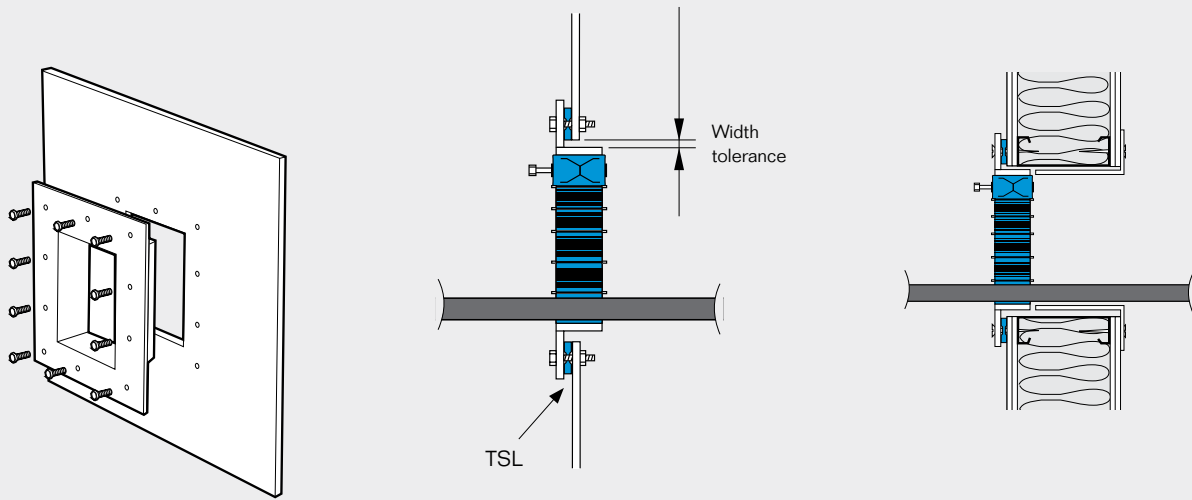

We recommend the use of our TSL 15x6 alternatively a sealing compound between the frame and the wall. Fixing arrangements, choice of fasteners and gasket/sealing must be adapted to the type of structure where the frame is installed. For fragile structures, we can supply special frames with wider flanges to reduce the risk of breaking the wall surface while installing with expandable bolts.

KFO/C KFO frames with flange, assembly

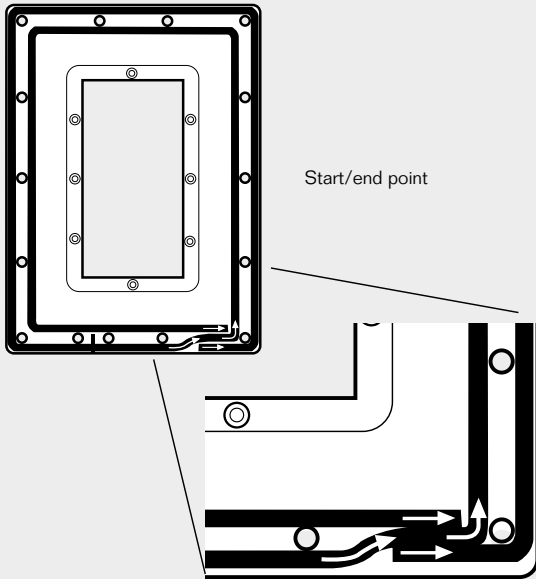

The TSL 15x6 sealing strip is applied on the flange side facing the wall.

Sleeves with flange, aperture dimensions for bolting



Frame/seal	Hole dim. for sleeve		Minimum clearance depth	
	Ø (mm)	Ø (in)	(mm)	(in)
R 70	95	3.740	60	2.362
R 75	95	3.740	60	2.362
R 100	125	4.921	60	2.362
R 125	150	5.906	60	2.362
R 127	150	5.906	60	2.362
R 150	180	7.087	60	2.362
R 200	230	9.055	60	2.362
RS 25	45	1.772	40	1.575
RS 31	50	1.969	40	1.575
RS 43	65	2.559	70	2.756
RS 50	70	2.756	70	2.756
RS 68	85	3.346	70	2.756
RS 75	95	3.740	70	2.756
RS 100	125	4.921	70	2.756
RS 125	150	5.906	70	2.756
RS 150	180	7.087	70	2.756
RS 175	190	7.480	60	2.362
RS 200	235	9.252	60	2.362
RS 225	260	10.236	60	2.362
RS 250	285	11.220	60	2.362
RS 300	335	13.189	60	2.362
RS 350	385	15.157	60	2.362
RS 400	435	17.126	60	2.362
RS 450	485	19.094	60	2.362
RS 500	535	21.063	60	2.362
RS 550	585	23.031	60	2.362
RS 600	635	24.999	60	2.362
RS 644	680	26.772	60	2.362

Sleeves, bolting guidelines

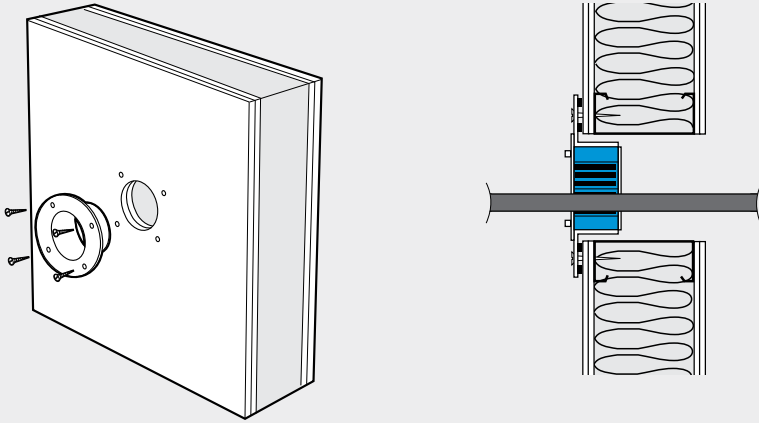

Cut a hole in the partition. Position the sleeve inside the hole with only the flange protruding. Attach the bolts as shown.

Insulation – important information

Installing and ensuring performance of Roxtec sealing solutions sometimes require the use of insulation.

As Roxtec holds a large number of certificates covering A, B and H class divisions as well as jet fire arrangements, the use of insulation varies not only depending on division but also on what type of services that penetrate the systems, such as cables, plastic pipes or metal pipes. Roxtec holds certificates towards several different classification societies, so the actual project is also a relevant factor when considering insulation arrangements.

Latest updates online

Roxtec continuously strives towards having the most effective setup to secure performance. Through our extensive testing this is a constantly ongoing work. In order to ensure that you get the latest updated certified installation arrangements, please visit www.roxtec.com or contact your local Roxtec representative for detailed information.

KFO/KFO frame with flange, holecut

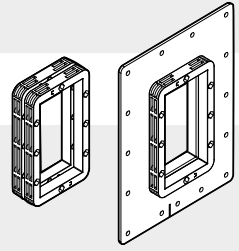

KFO

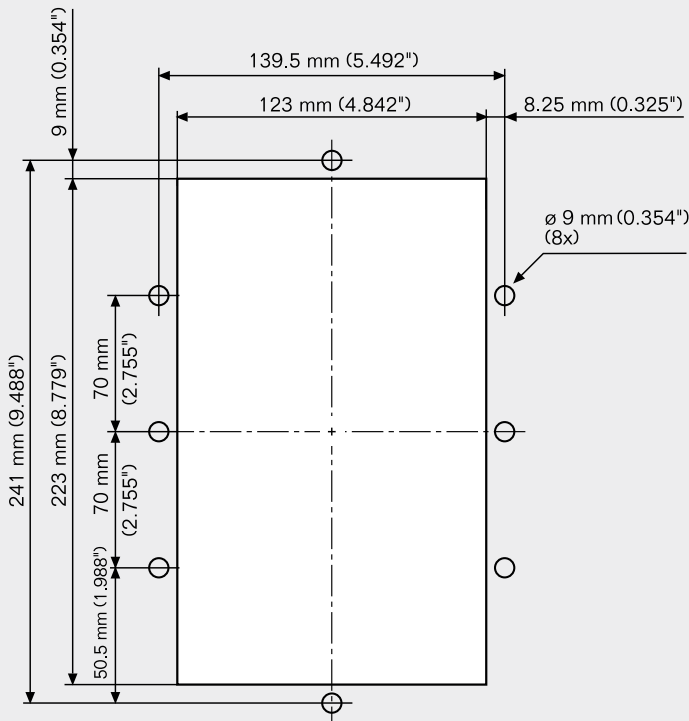

KFO 6x1 with flange

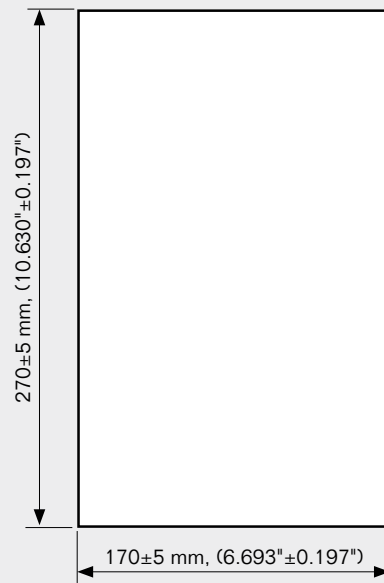

Not scale 1:1

C KFO/C KFO frame with flange, holecut

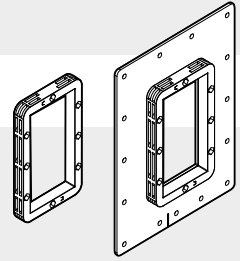

C KFO

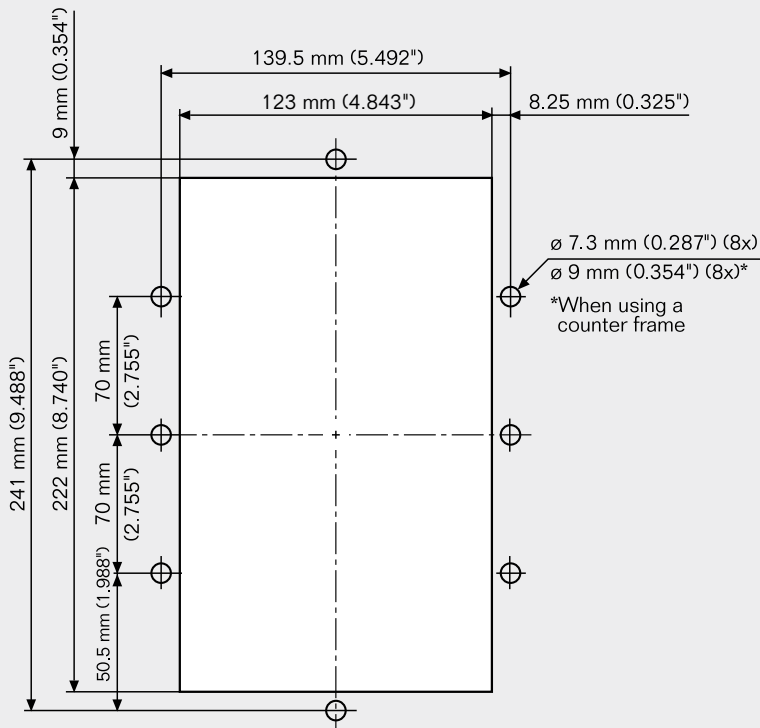

C KFO 6x1 with flange

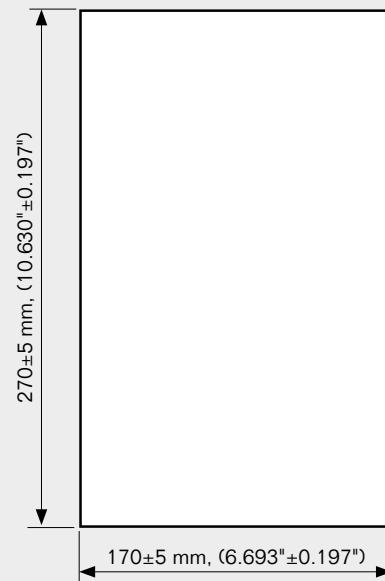

Not scale 1:1

CF 8 and CF 32 frames, holecut

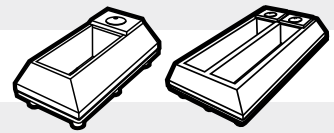

CF 8

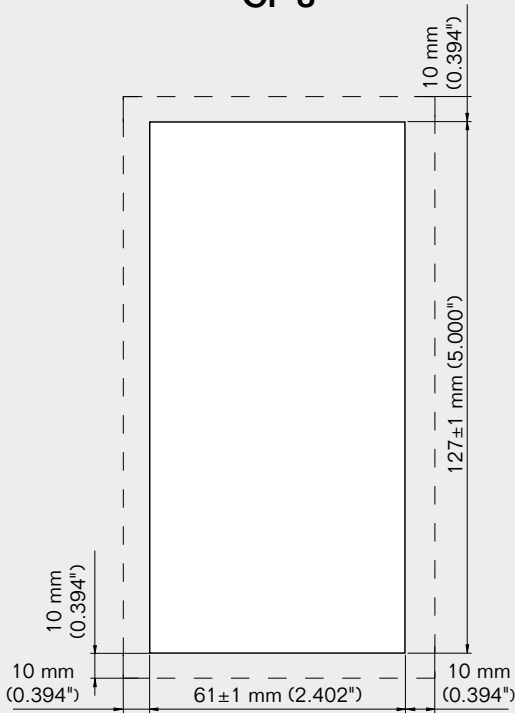

CF 32

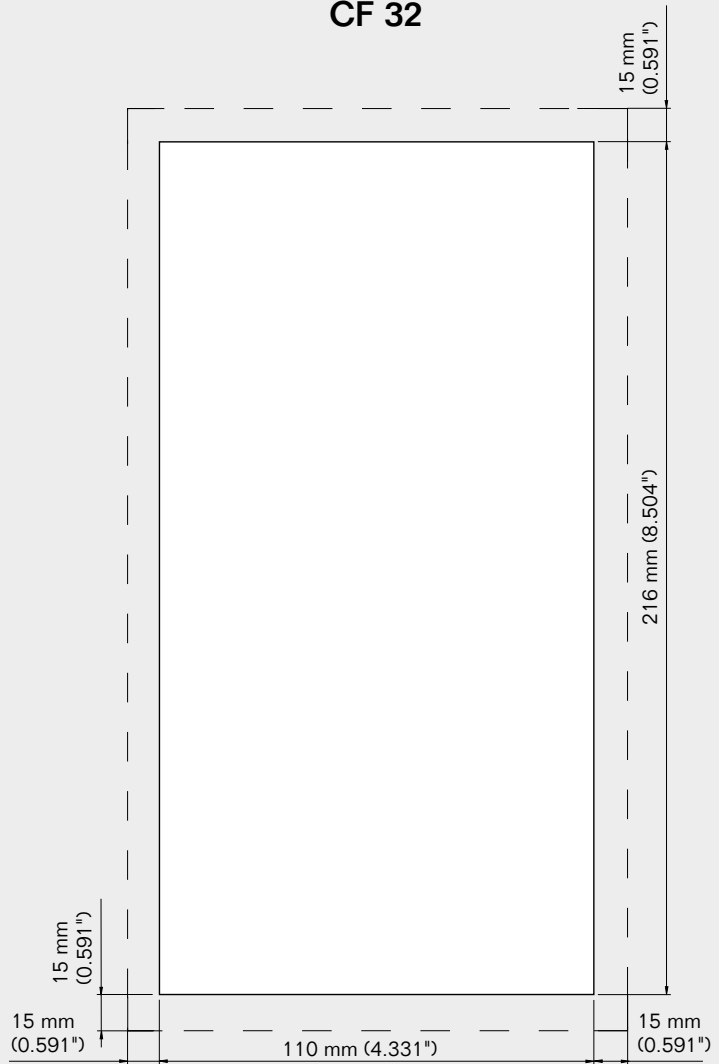

Area that must be unpainted (conductive) for EMC installations.

Not scale 1:1

ComSeal™ LW 6, LW 12 frames, holecut

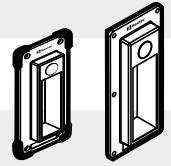

ComSeal™ LW 6

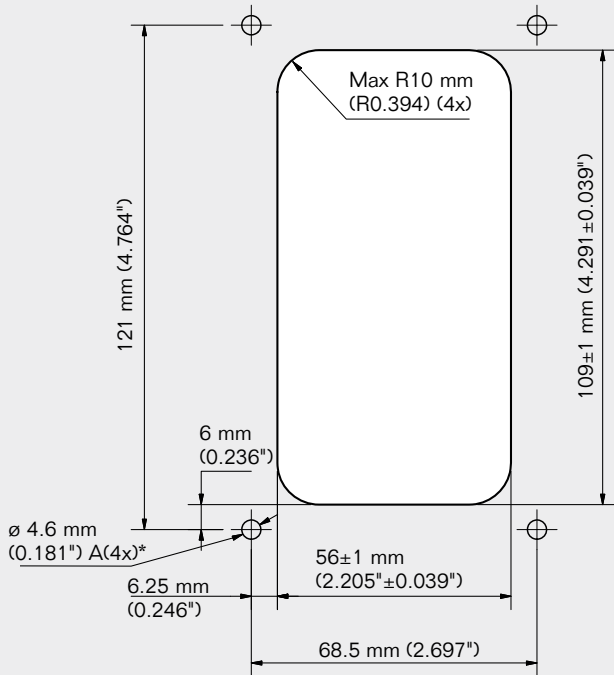

ComSeal™ LW 12

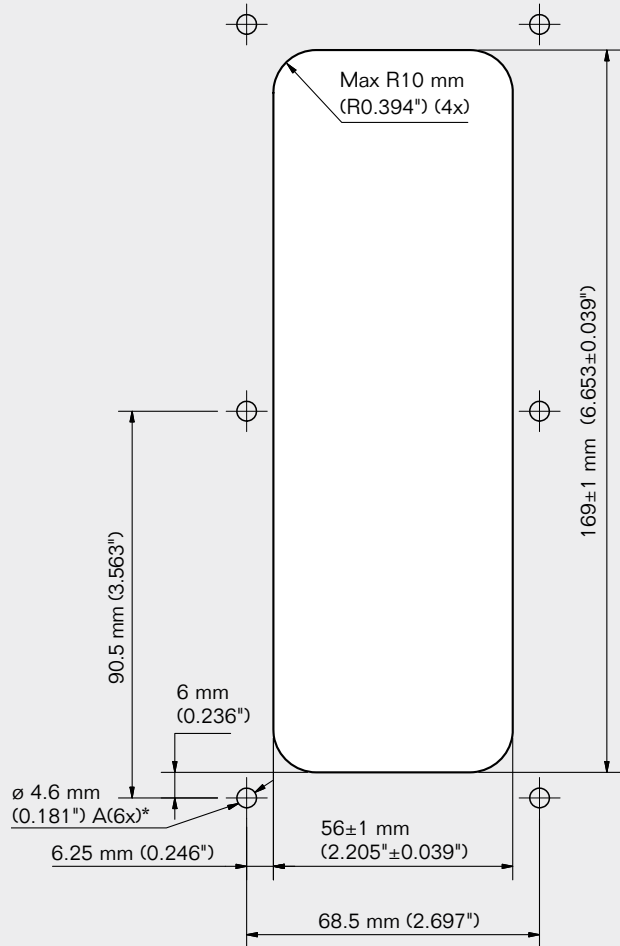

Roxtec ComSeal™ LW 12 fits FL 21 knock-out (holecut).

* \varnothing 5.5 (7/32"). Drill bit size when using nuts.

Not scale 1:1

ComSeal™ LW 12 FL 21, LW 16 frames, holecut



ComSeal™ LW 12 FL 21

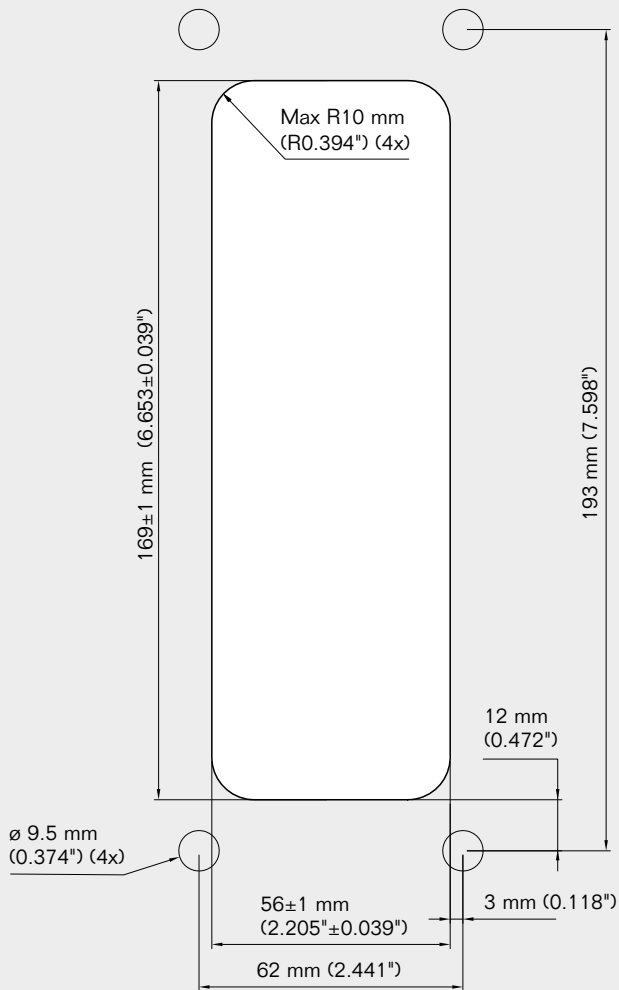

ComSeal™ LW 16

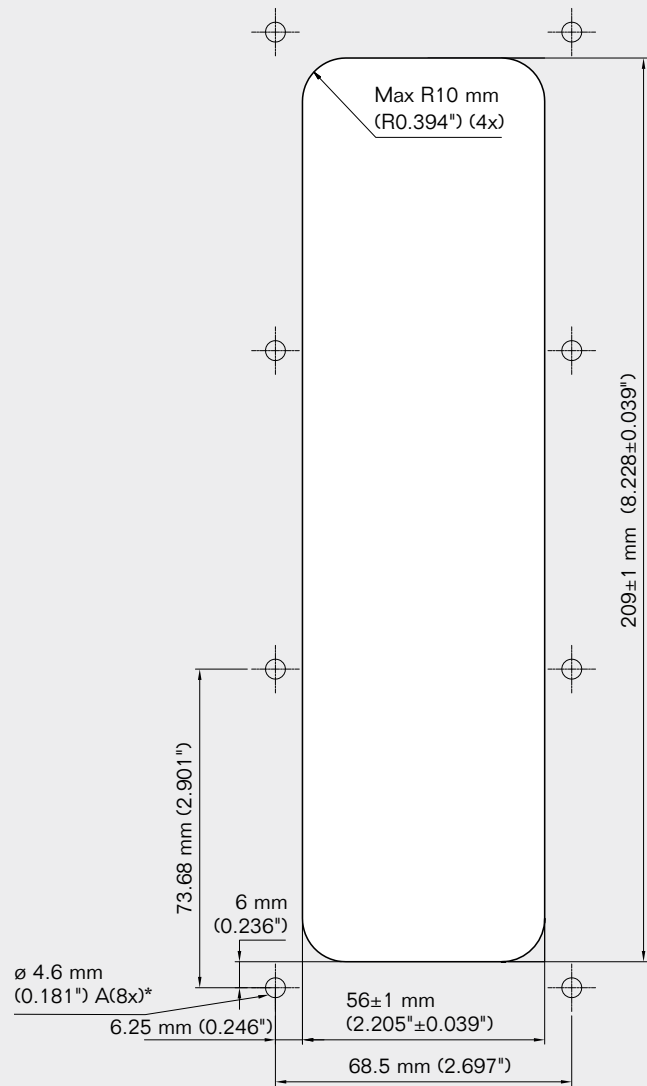

Not scale 1:1

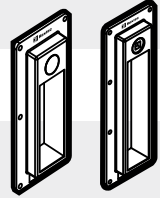

ComSeal™ 15, 16 frames, holecut

ComSeal™ 15

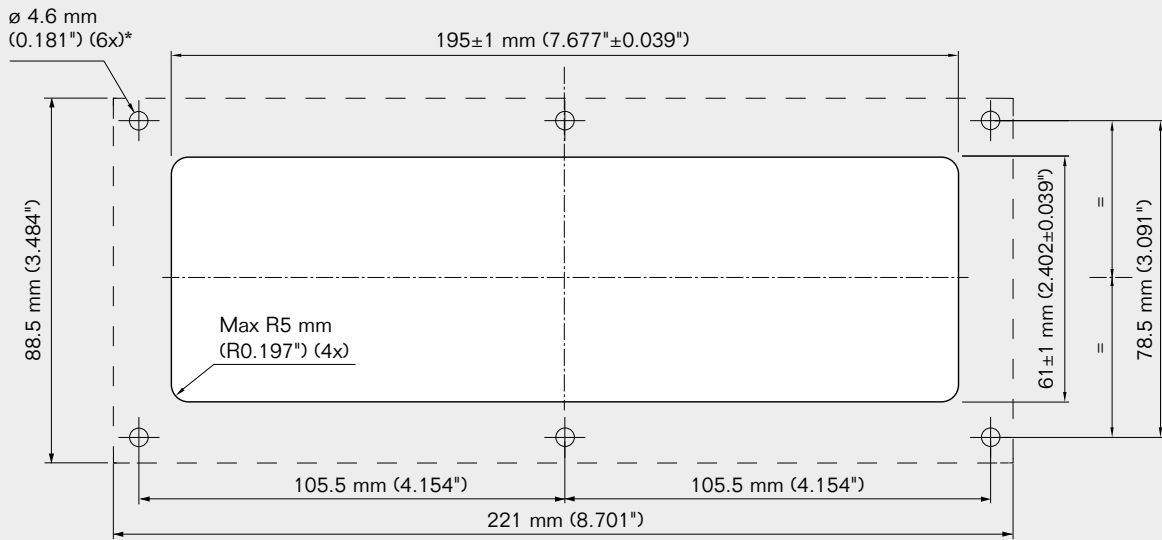

ComSeal™ 16

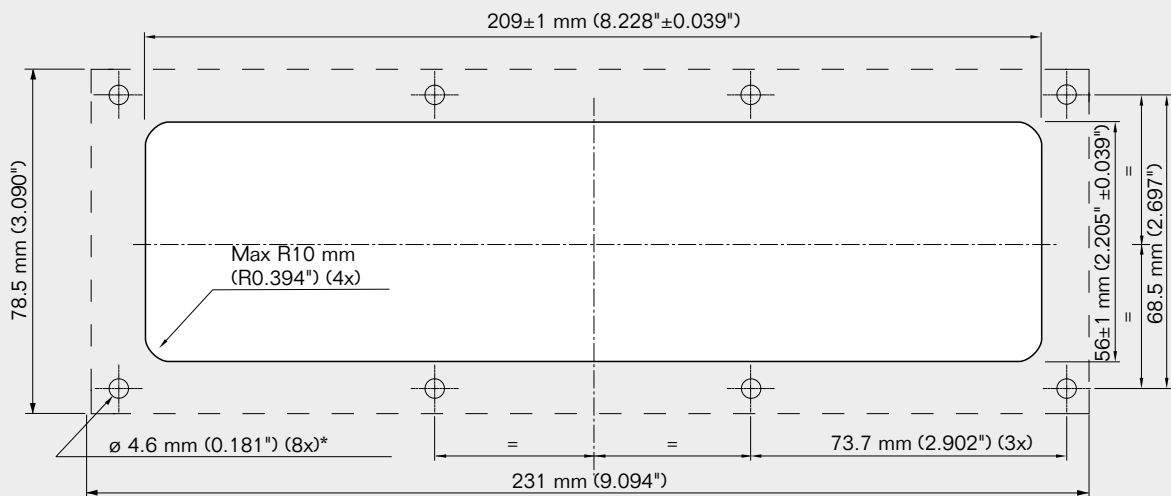

Area that must be unpainted (conductive) for EMC installations.

* $\varnothing 5.5$ ($7/32''$). Drill bit size when using nuts.

Not scale 1:1

ComSeal™ 30, 32 frames, holecut

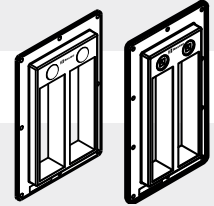

ComSeal™ 30

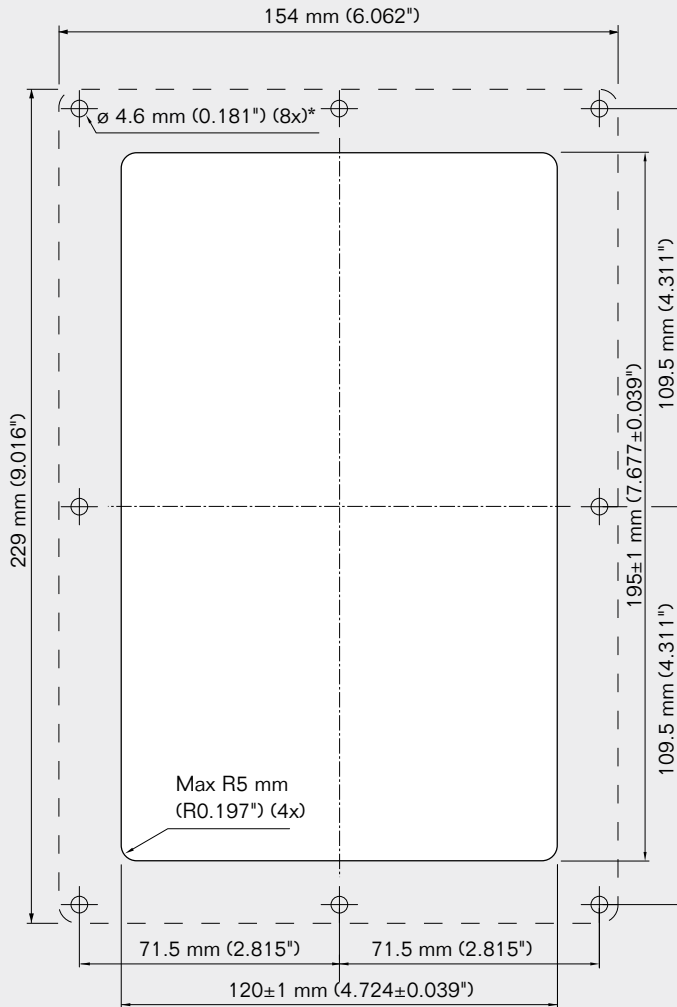

ComSeal™ 32

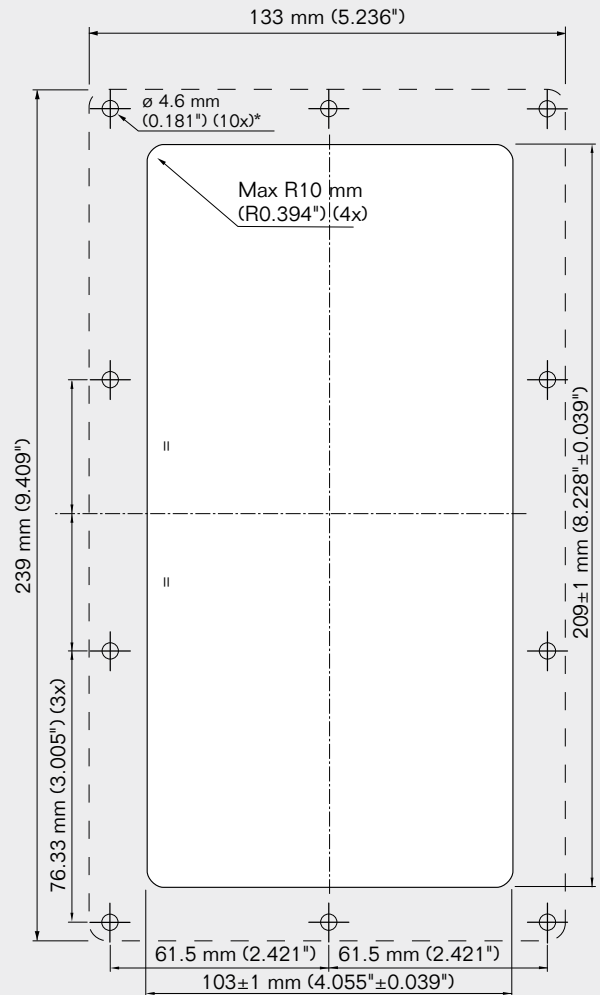

Area that must be unpainted (conductive) for EMC installations.

* \varnothing 5.5 (7/32"). Drill bit size when using nuts.

Not scale 1:1

ComSeal™ 10 AISI 316, 16 AISI 316 frames, holecut

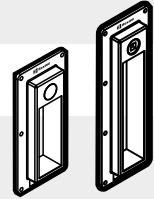

ComSeal™ 10 AISI 316

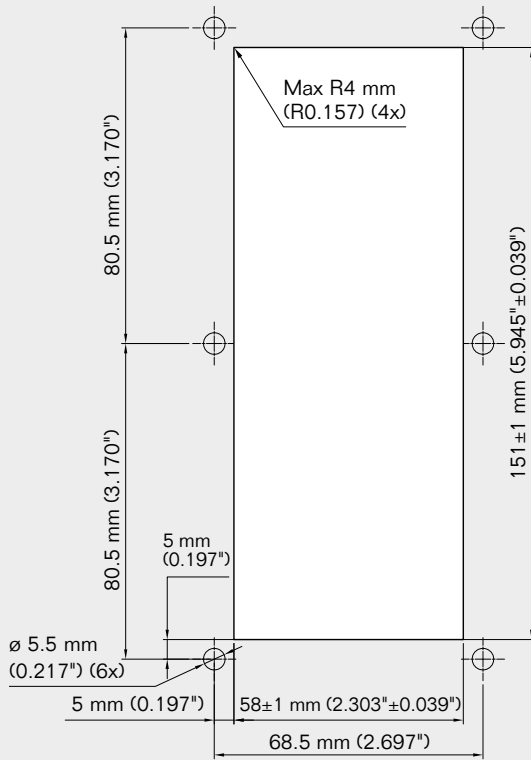

ComSeal™ 16 AISI 316

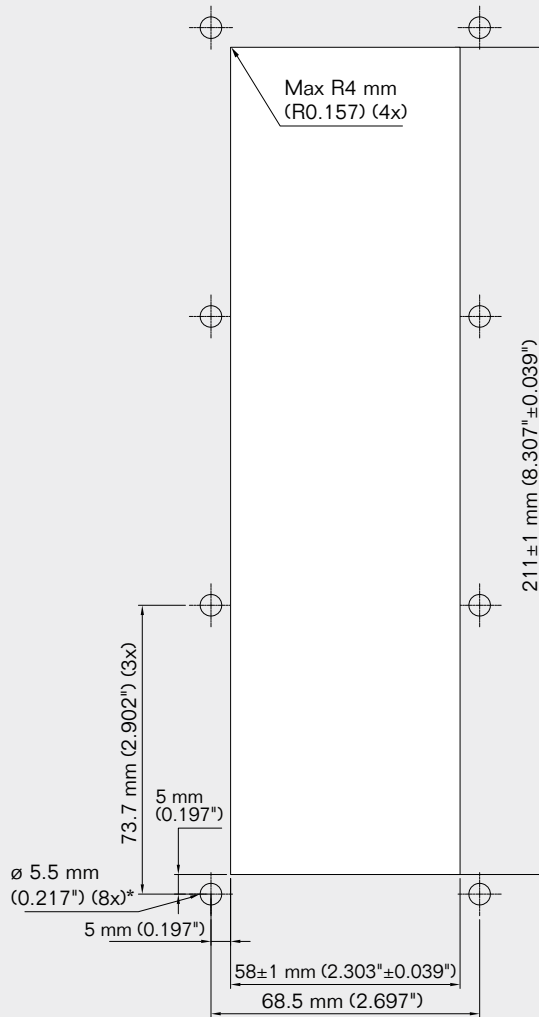

Not scale 1:1

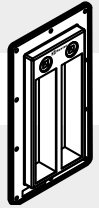

ComSeal™ 32 AISI 316 frame, holecut

ComSeal™ 32 AISI 316

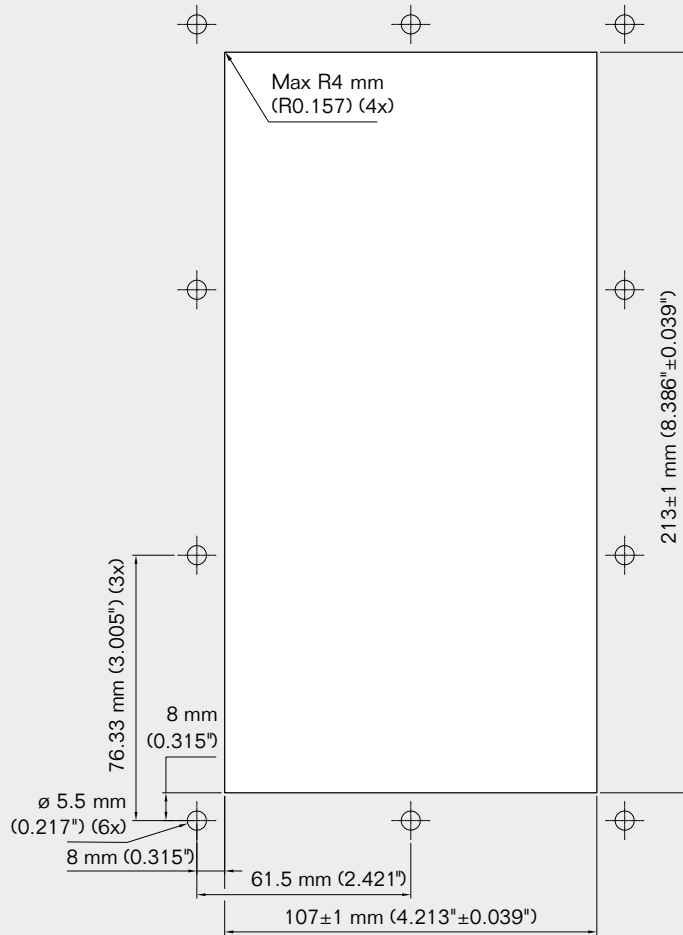

Not scale 1:1

ALL RIGHTS RESERVED

We reserve the right to make changes to the product and technical information without further notice. Any errors in print or entry are no claims for indemnity. The content of this publication is the property of Roxtec International AB and is protected by copyright.

DISCLAIMER

"The Roxtec cable entry sealing system ("the Roxtec system") is a modularbased system of sealing products consisting of different components. Each and every one of the components is necessary for the best performance of the Roxtec system. The Roxtec system has been certified to resist a number of different hazards. Any such certification, and the ability of the Roxtec system to resist such hazards, is dependent on all components that are installed as a part of the Roxtec system. Thus, the certification is not valid and does not apply unless all components installed as part of the Roxtec system are manufactured by or under license from Roxtec ("authorized manufacturer"). Roxtec gives no performance guarantee with respect to the Roxtec system, unless (I) all components installed as part of the Roxtec system are manufactured by an authorized manufacturer and (II) the purchaser is in compliance with (a), and (b), below.

(a) During storage, the Roxtec system or part thereof, shall be kept indoors in its original packaging at room temperature.

(b) Installation shall be carried out in accordance with Roxtec installation instructions in effect from time to time.

The product information provided by Roxtec does not release the purchaser of the Roxtec system, or part thereof, from the obligation to independently determine the suitability of the products for the intended process, installation and/or use. Roxtec gives no guarantee for the Roxtec system or any part thereof and assumes no liability for any loss or damage whatsoever, whether direct, indirect, consequential, loss of profit or otherwise, occurred or caused by the Roxtec systems or installations containing components not manufactured by an authorized manufacturer and/or occurred or caused by the use of the Roxtec system in a manner or for an application other than for which the Roxtec system was designed or intended.

Roxtec expressly excludes any implied warranties of merchantability and fitness for a particular purpose and all other express or implied representations and warranties provided by statute or common law. User determines suitability of the Roxtec system for intended use and assumes all risk and liability in connection therewith. In no event shall Roxtec be liable for indirect, consequential, punitive, special, exemplary or incidental damages or losses."

Roxtec ® is a registered trademark of Roxtec in Sweden and/or other countries.

Multidiameter ® is a registered trademark of Roxtec in Sweden and/or other countries.

Roxtec system, a number of products used for cable and pipe entries.

© Roxtec International AB 2016 Photo/illustration: Roxtec AB, Production: Roxtec Market Communications



Roxtec International AB
Box 540, SE-371 23 Karlskrona, SWEDEN
PHONE +46 455 36 67 00, FAX +46 455 820 12
EMAIL info@roxtec.com, www.roxtec.com